



SURGICAL
INSTRUMENTS



01-101
TROEMNER
Size: 245 mm



01-102
DEJERINE
Size: 200 mm



01-103
DEJERINE
With Needle
Size: 210 mm



01-104
TAYLOR
Size: 195 mm



01-105
BERLINER
Size: 200 mm

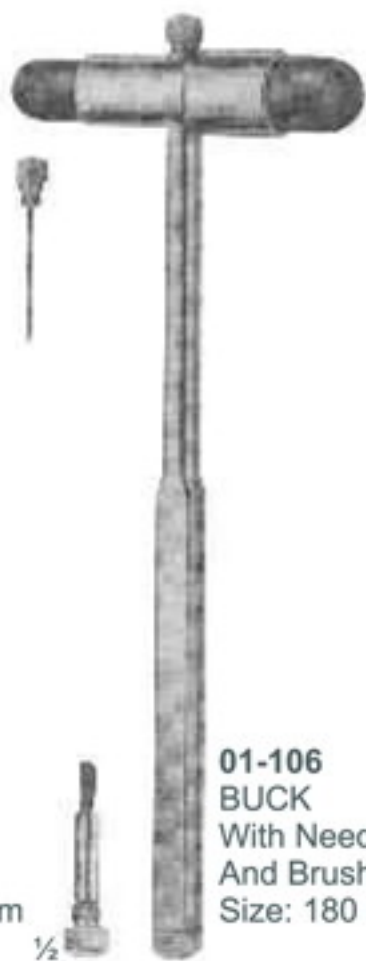

01-106
BUCK
With Needle
And Brush
Size: 180 mm

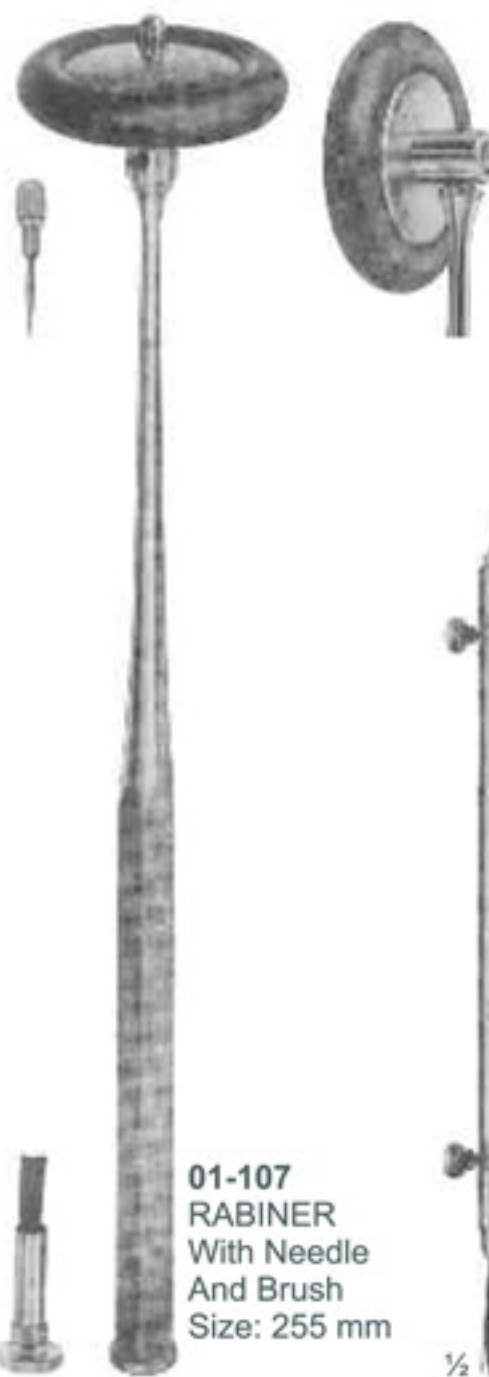

01-107
RABINER
With Needle
And Brush
Size: 255 mm



01-108
ALY
Size: 190 mm



01-109
WARTENBERG
Pinwheel For
Neurological
Examination
Size: 185 mm



01-110
PINARD (Aluminum)
Size: 155 mm

½



01-111
aus Holz (Wooden)
Size: 145 mm

½



01-112
BOWLES
Stethoscope
With Diaphragm

¼



01-113
ANESTOPHON

⅓



01-114
FORD-BOWLES
Duel Chest Piece
With Two Outlets

¼



01-115
BOWLES

¼



01-116
ZIEGLER \varnothing mm
Head mirror only
with rubber coating



01-117
ZIEGLER \varnothing mm
Head mirror only
with metal coating



01-118
ZIEGLER
Head band of plastic black



01-120
MURPHY
Head band of celluloid, white

01-119
ZIEGLER
Head band of plastic white



01-121
Head band of plastic,
white, soft pattern



01-122
Head mirror with black
plastic head band.

01-123
CLAR
Head light, 6 volt, with adjustable joint,
white celluloid head band,
cord with plugs for transformer

01-124
White celluloid head band, only, for

01-125
Spare mirror only, for



01-127
CLAR
Head light, 6 volt, with adjustable joint,
white celluloid head band, with foam rubber pad
and cord with plugs for transformer

01-128
White celluloid head band, only, for head light

01-129
mirror only, for head light

spare foam rubber pad, for head band



01-131
CLAR
Head light, 6 volt, with adjustable joint,
white plastic head band,
cord with plugs for transformer



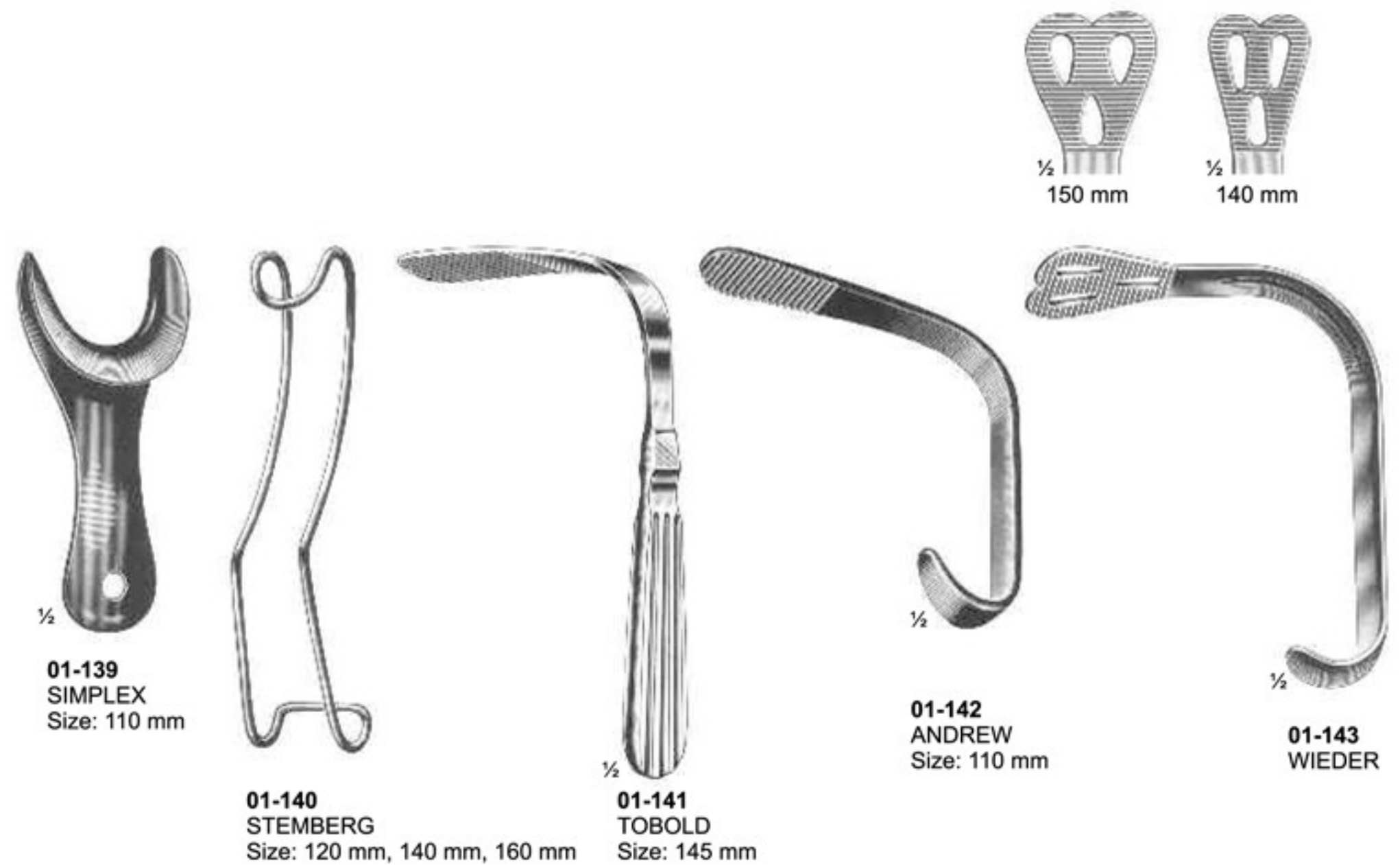
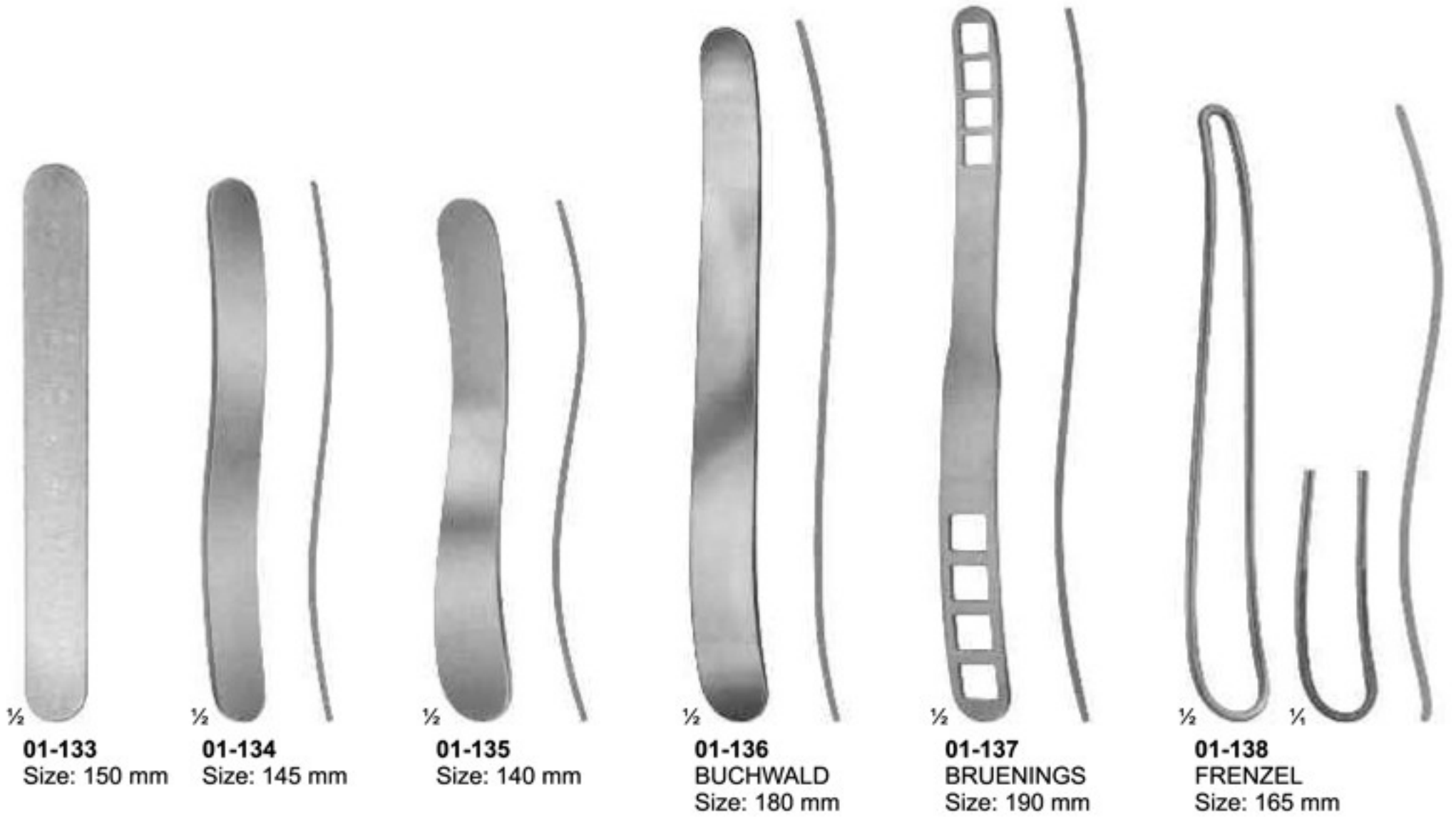



½

01-144
SCHIMMELBUSCH
Ether Mask



½

01-145
HEISTER
Mouth Gag
Size: 130 mm



½

01-146
FERGUSSON-ACKLAND
Mouth Gag
Size: 145 mm



½

01-147
DENHARDT
Mouth Gag With Silicon
Inserts, Interchangeable
Size: 125 mm



½

01-148
ROSER KONIG
Mouth Gag
Size: 160 mm, 185 mm

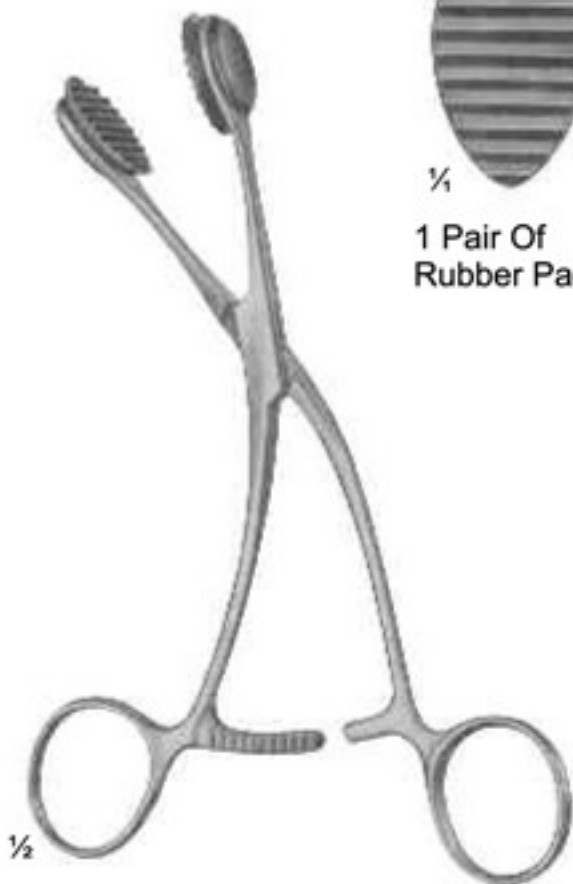

½

01-149
YOUNG
Size: 165 mm



¼

1 Pair Of
Rubber Pads

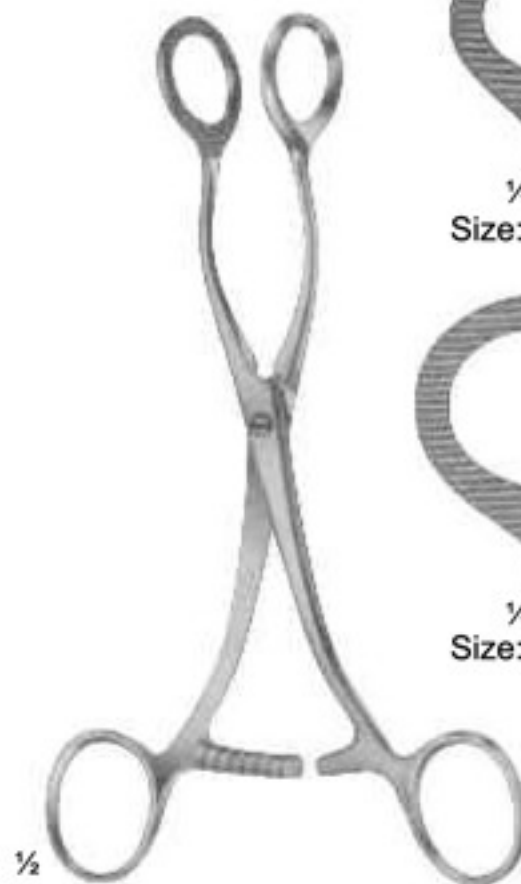

½

01-150
COLLIN
Size: 160 mm, 170 mm



¼

Size: 160 mm



¼

Size: 170 mm



½

01-151
HEYWOOD-SMITH modif.
Size: 215 mm



¼



01-152
FRANCKE
Automatic Blood Lancet



01-153
KOLLE
Microscopic Needle Holder
With Plastic Handle
Size: 240 mm

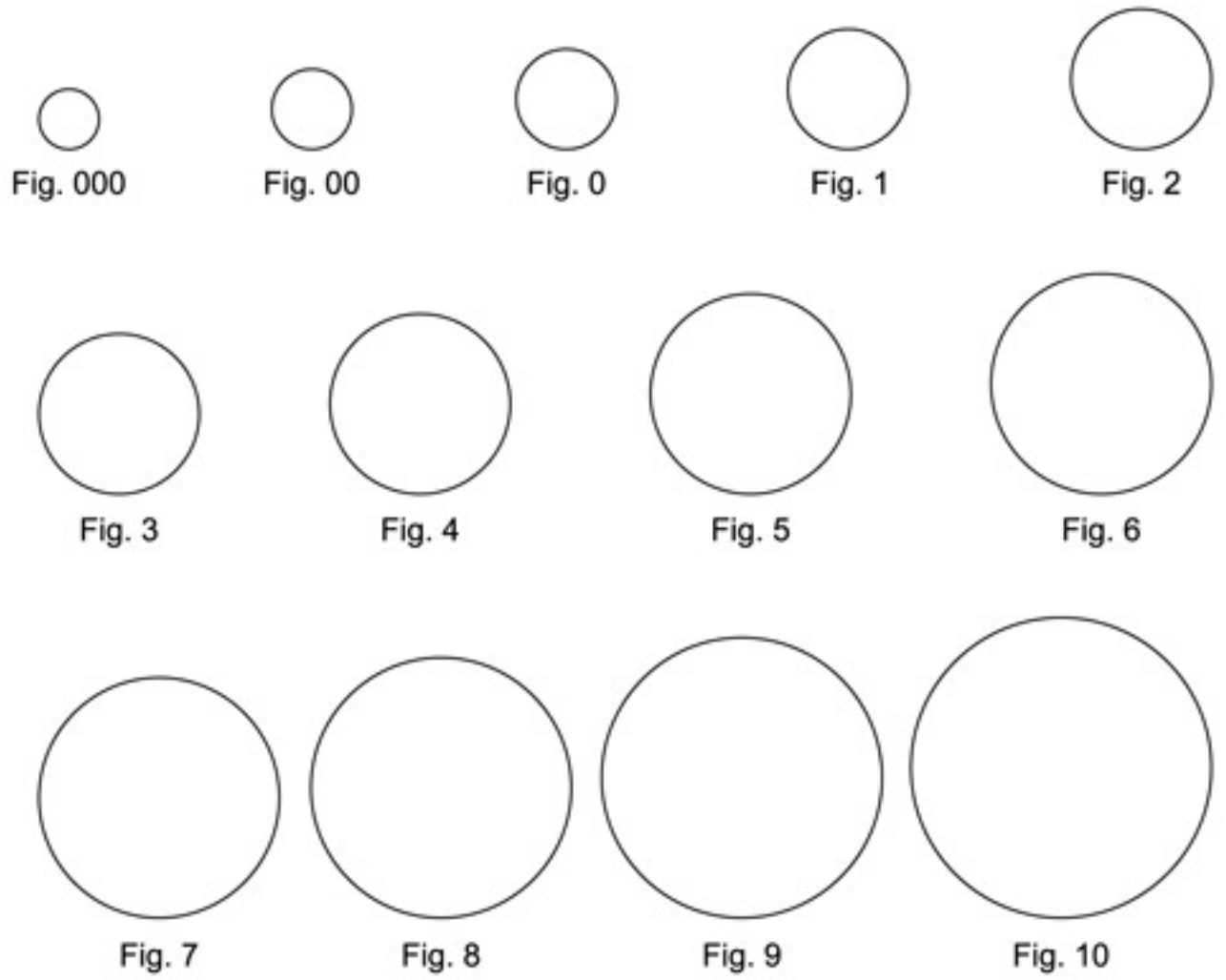

01-158
Spare Mirrors Only
Size: 12 mm



01-159
Spare Mirrors Only
Size: 14 mm



01-154
Laryngeal Mirrors With
Hexagonal Handle
Size: 180 mm



01-155
Mirror Handle
Size: 110 mm



01-156
Mirror Handle
Size: 105 mm



01-157
MICHEL
Rhinoscopic Mirrors With
Interchangeable Mirror Inserts
Size: 250 mm



1/2

01-160 - 162
MAGILL



1/4

01-160
Infants
Size: 150 mm



1/4

01-161
Children
Size: 200 mm



1/4

01-162
Adults
Size: 250 mm



1/2

01-163
Medium battery handle
only, 25 mm diam.



01-163-A
Spare bulb
2.7 volt, for
otoscopes



01-163-B
Spare bulb
2.6 volt, for
ophthalmoscopes



01-164
Otoscope Set, Consists Of
Battery Handle Without Batteries,
3 Ear Specula, 1 Bulb In Valvet Lined Case



01-165
Diagnostic Set, Otoscope With Three Specula,
Nasal Speculam, Lamp Holder, Two Laryngeal
Mirrors, Tongue Blade Holder

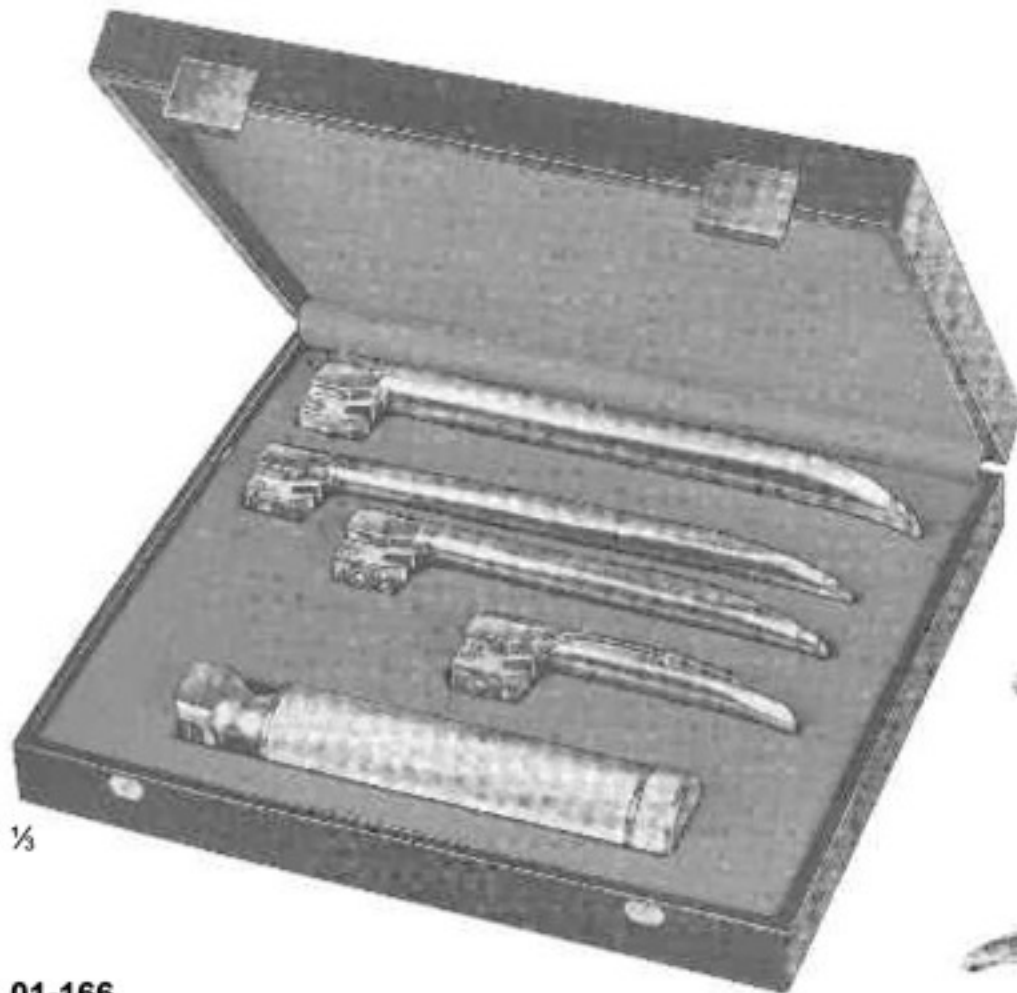

01-166
MILLER
 Laryngoscope Set, Consists Of Battery Handle (Without Battery)
 With Four Miller Laryngoscope Blades

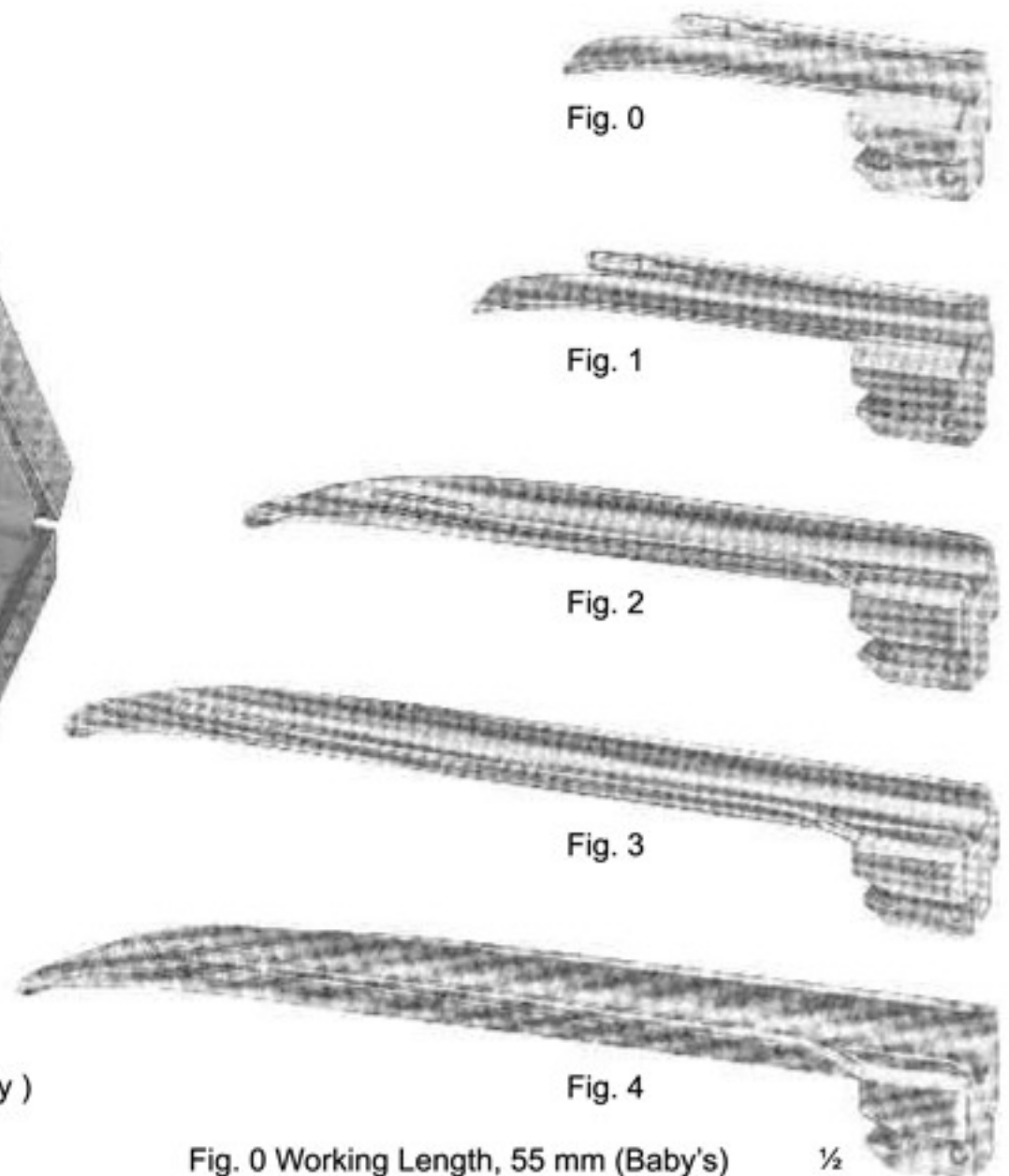

Fig. 0 Working Length, 55 mm (Baby's) 1/2
 Fig. 1 Working Length, 80 mm (Children's)
 Fig. 2 Working Length, 130 mm (Adolescent's)
 Fig. 3 Working Length, 170 mm (Women's)
 Fig. 4 Working Length, 180 mm (Men's)



01-167
GUEDEL-NEGUS
 Laryngoscope Set, Consists Of Battery Handle (Without Battery)
 With Four Miller Laryngoscope Blades

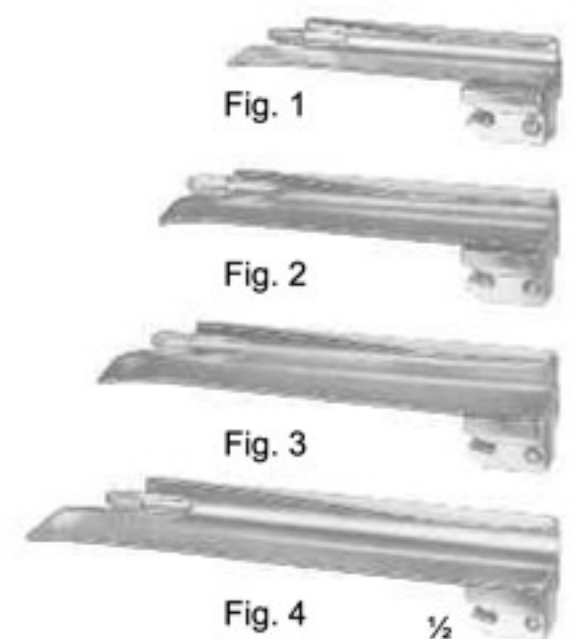

Fig. 1 Working Length, 70 mm (Children's)
 Fig. 2 Working Length, 90 mm (Adolescent's)
 Fig. 3 Working Length, 110 mm (Women's)
 Fig. 4 Working Length, 135 mm (Men's)



01-168
McIntosh
Laryngoscope Set, Consists Of Battery Handle (Without Battery)
With Three McIntosh Blades, Fig. 1, Fig. 2, Fig. 3

1/2

Fig. 0

Fig. 1

Fig. 2

Fig. 3

Fig. 4

01-169
McIntosh
Laryngoscope Set, Consists Of Battery Handle (Without Battery)
With Five McIntosh Blades, Fig. 1, Fig. 2, Fig. 3, Fig. 4, Fig. 5

- Fig. 0 Working Length, 55 mm (Baby's)
- Fig. 1 Working Length, 75 mm (Children's)
- Fig. 2 Working Length, 90 mm (Adolescent's)
- Fig. 3 Working Length, 110 mm (Women's)
- Fig. 4 Working Length, 135 mm (Men's)



01-170
FOREGGER
Laryngoscope Set, Consists Of
Battery Handle (Without Battery)
With Three Foregger Blades,
Fig. 1, Fig. 2, Fig. 3,

1/2

Fig. 1

Fig. 2

Fig. 3

Fig. 4

01-171
FOREGGER
Laryngoscope Set, Consists Of
Battery Handle (Without Battery)
With Five Foregger Blades,
Fig. 1, Fig. 2, Fig. 3, Fig. 4, Fig. 5

- Fig. 1 Working Length, 70 mm (Children's)
- Fig. 2 Working Length, 90 mm (Adolescent's)
- Fig. 3 Working Length, 110 mm (Women's)
- Fig. 4 Working Length, 135 mm (Men's)



01-172
Fiber Optic
Battery Handle

1/2



01-173
Fiber Optic
Battery Handle

1/2



01-174
Replacement Lamp
(Krypton) 2.5 V

1/4



01-175
Replacement Lamp
(Halogen) 2.5 V

1/4

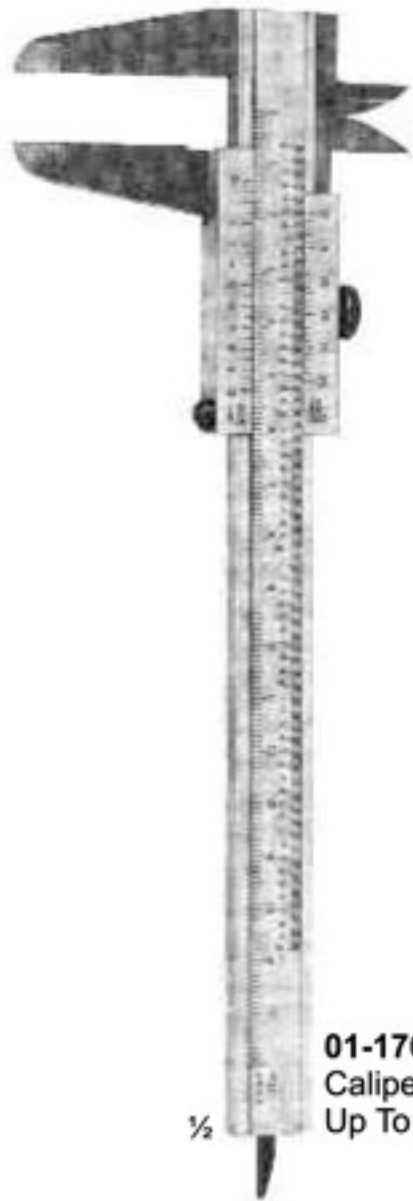

01-176
Caliper Of Aluminum
Up To 180 mm



01-177
VERNIER
Universal Caliper Of Steel
Up To 120 mm



01-178
CAROLL
Size: 140 mm



01-179
TOWNLEY
Size: 100 mm



01-180
COLLIN
Druck Pressure 72 kg
Size: 125 mm



01-181
BERTILLON
Caliper For Measuring The Head
Size: 320 mm



01-182
CASTROVIEJO
Caliper



01-183
MOLTGEN
Goniometer



01-185
Size: 150 mm



01-184
Size: 500 mm





02-101 - 110
Fig. 1 - 10



02-101
Fig. 1



02-102
Fig. 2



02-103
Fig. 3



02-104
Fig. 4



02-105
Fig. 5



02-106
Fig. 6



02-107
Fig. 7



02-108
Fig. 8



02-109
Fig. 9



02-110
Fig. 10

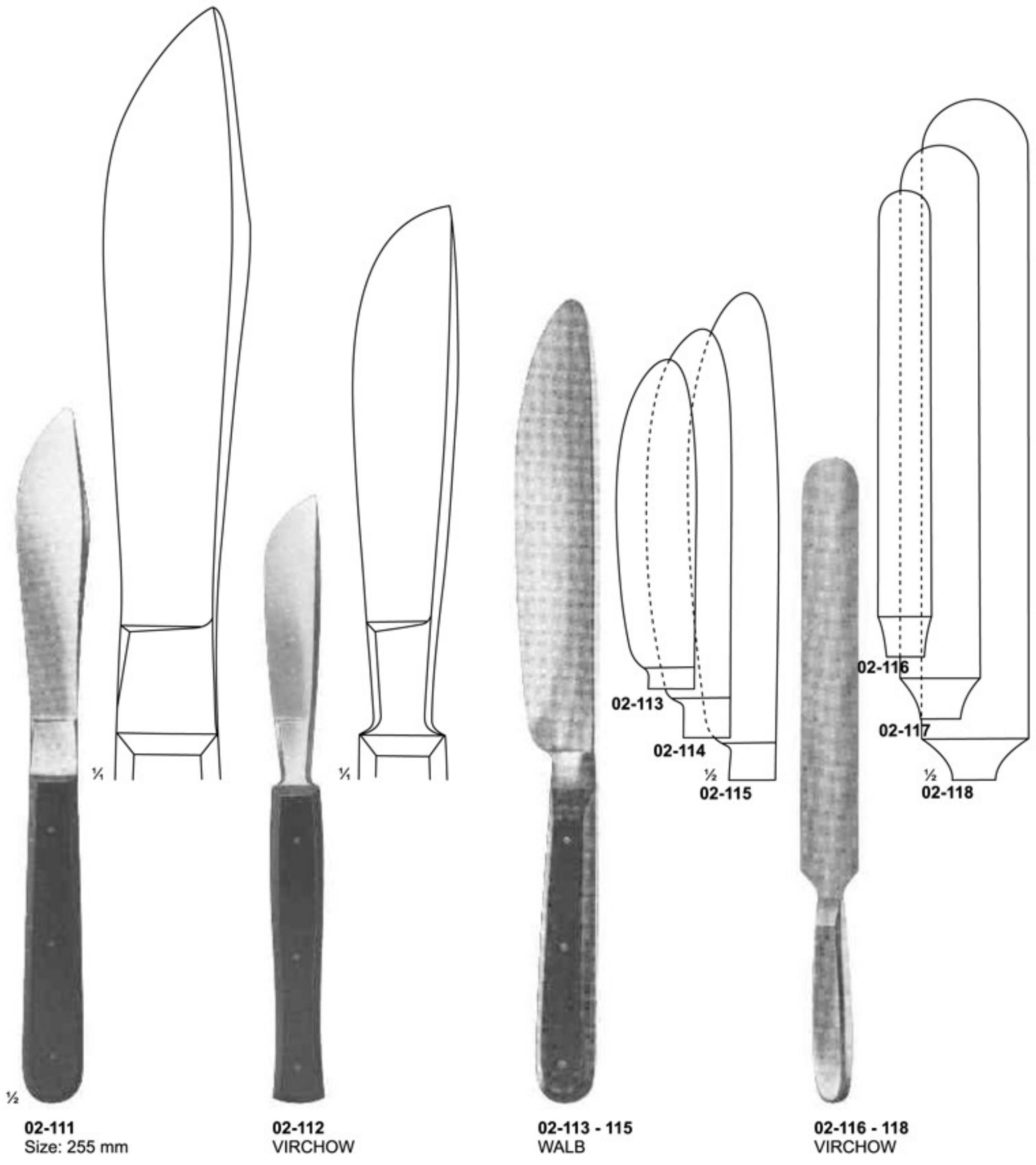

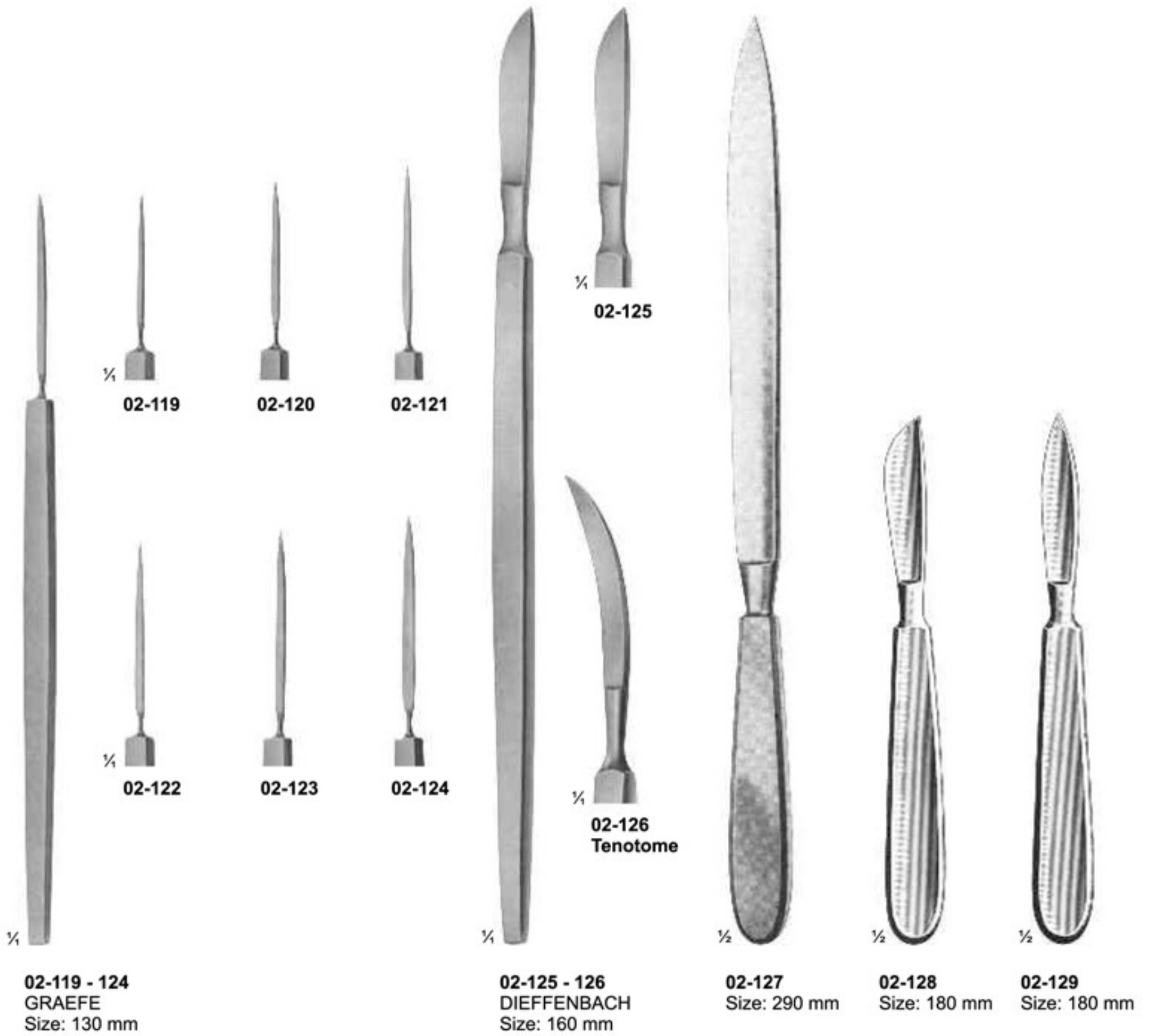

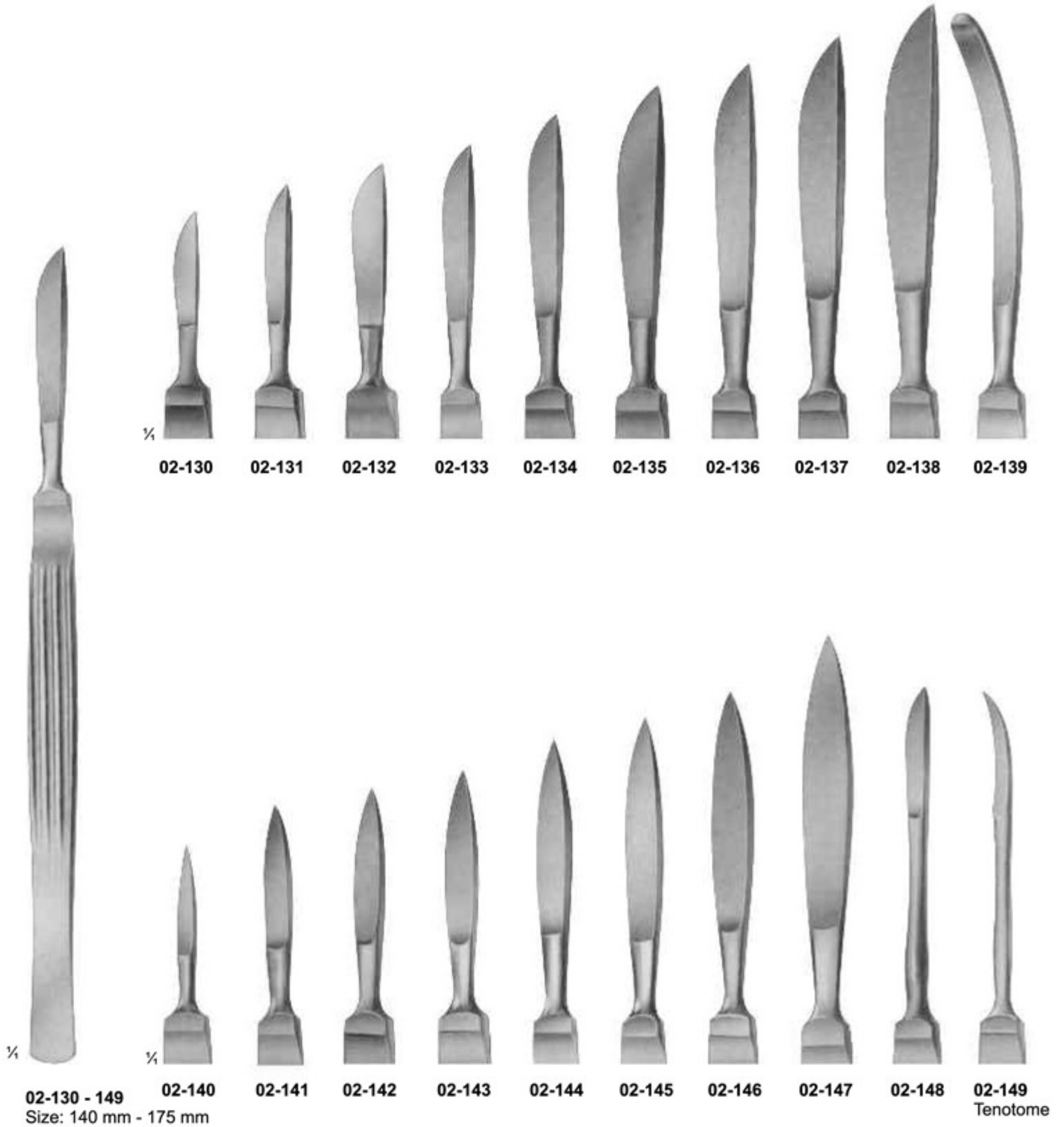

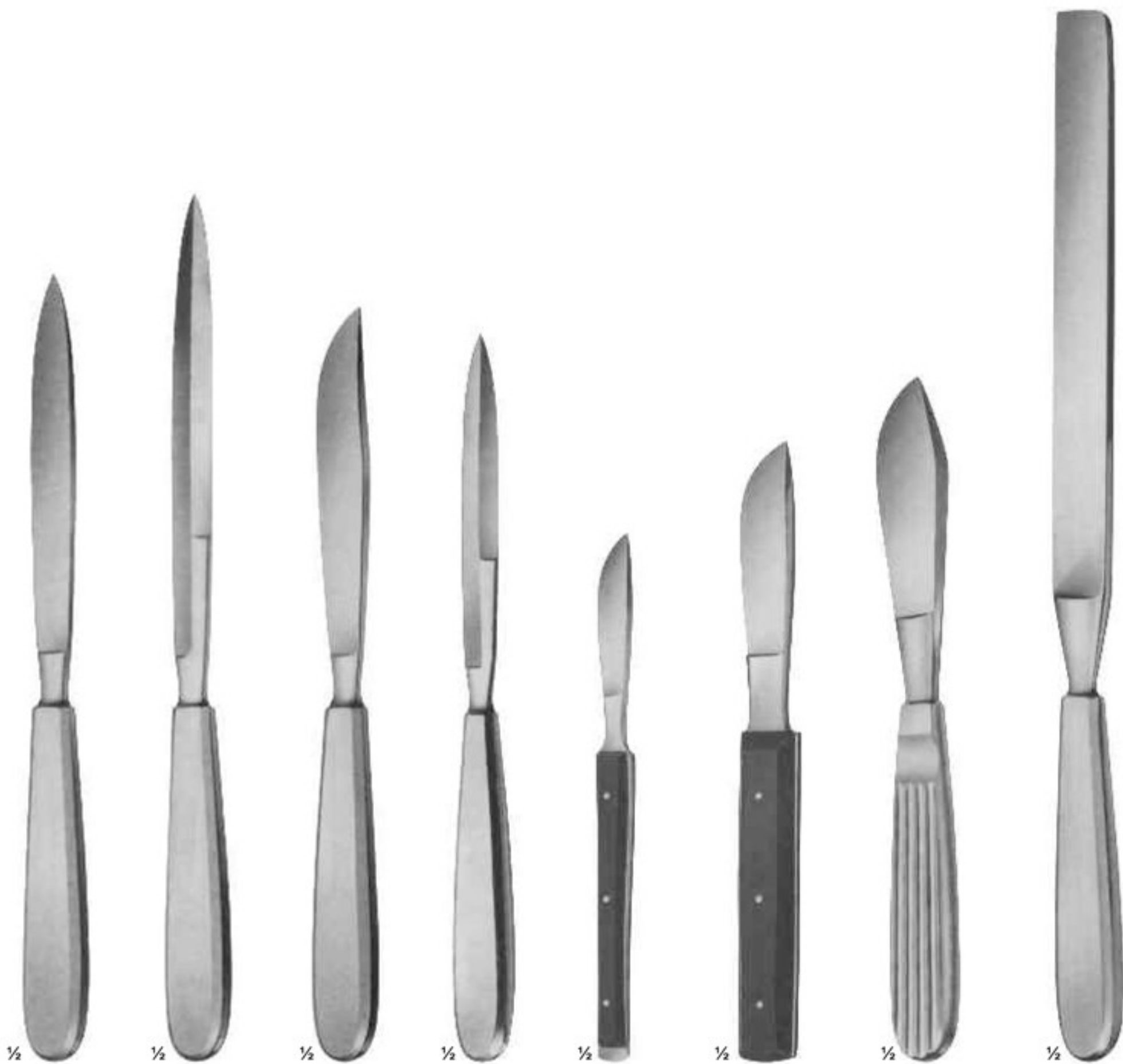

02-150
Size: 130 mm
02-151
Size: 160 mm
02-152
Size: 190 mm
02-153
Size: 200 mm

02-154
CATLIN
Size: 160 mm
Blade Length
Amputating
Knives

02-155
LANGENBECK
Size: 120 mm
Blade Length
Flap Knives

02-156
Size: 110 mm
Blade Length
Interosseous
Knives

02-157
Size: 55 mm
Blade Length
With Raspatory,
Wooden Handle

02-158
Size: 70 mm
Blade Length
Wooden Handle

02-159
Size: 80 mm
Blade Length
Metal Handle

02-160
Size: 195 mm
Blade Length
Metal Handle

Blade Length
Amputating Knives



02-161
AYRE
 Size: 235 mm
 Cone Knife

02-162
 Size: 230 mm
 Cone Knife

02-163
SEGOND
 Size: 270 mm
 Myomatome

02-164
OLIVECRONA
 Size: 205 mm
 Trigeminal
 Knife

02-165
 Size: 230 mm
 Trigeminal
 Knife

02-166
FOWLER
 Size: 200 mm
 Tonsil Knife

02-167
ABRAHAM
 Size: 215 mm
 Tonsil Knife

02-168
BRUNINGS
 Size: 215 mm
 Tonsil Knife

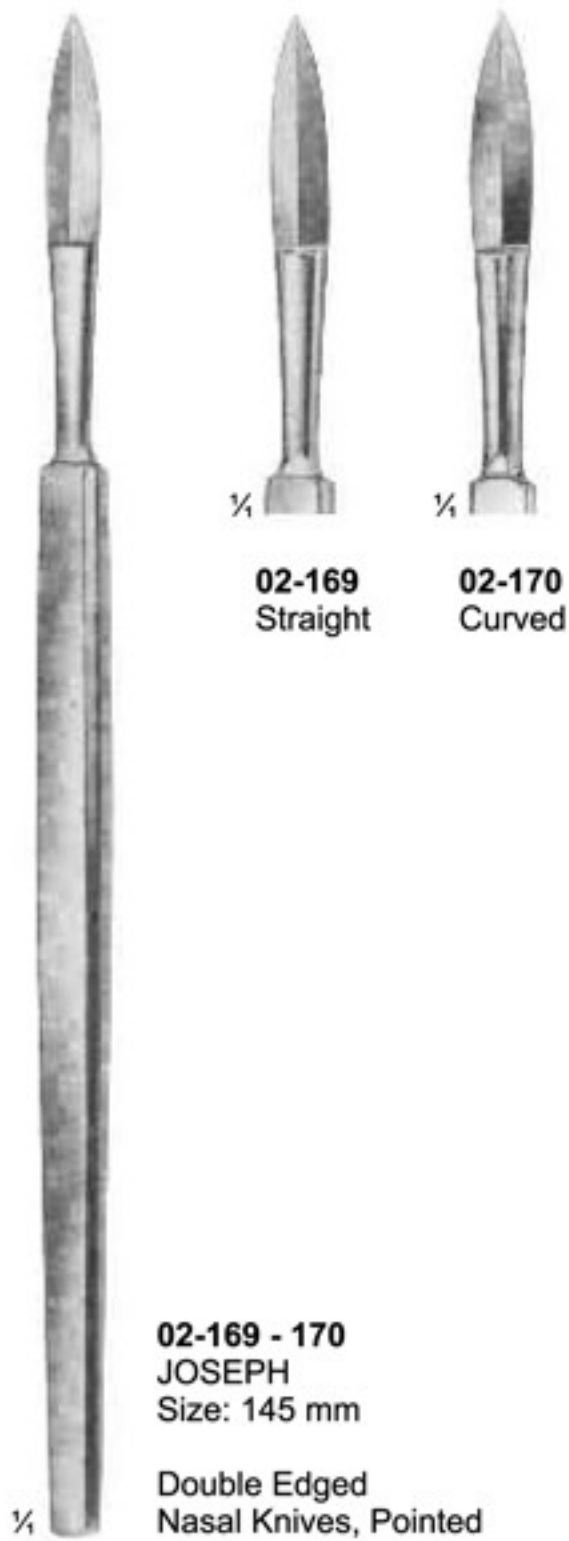

02-169
Straight

02-170
Curved

02-169 - 170
JOSEPH
Size: 145 mm

Double Edged
Nasal Knives, Pointed

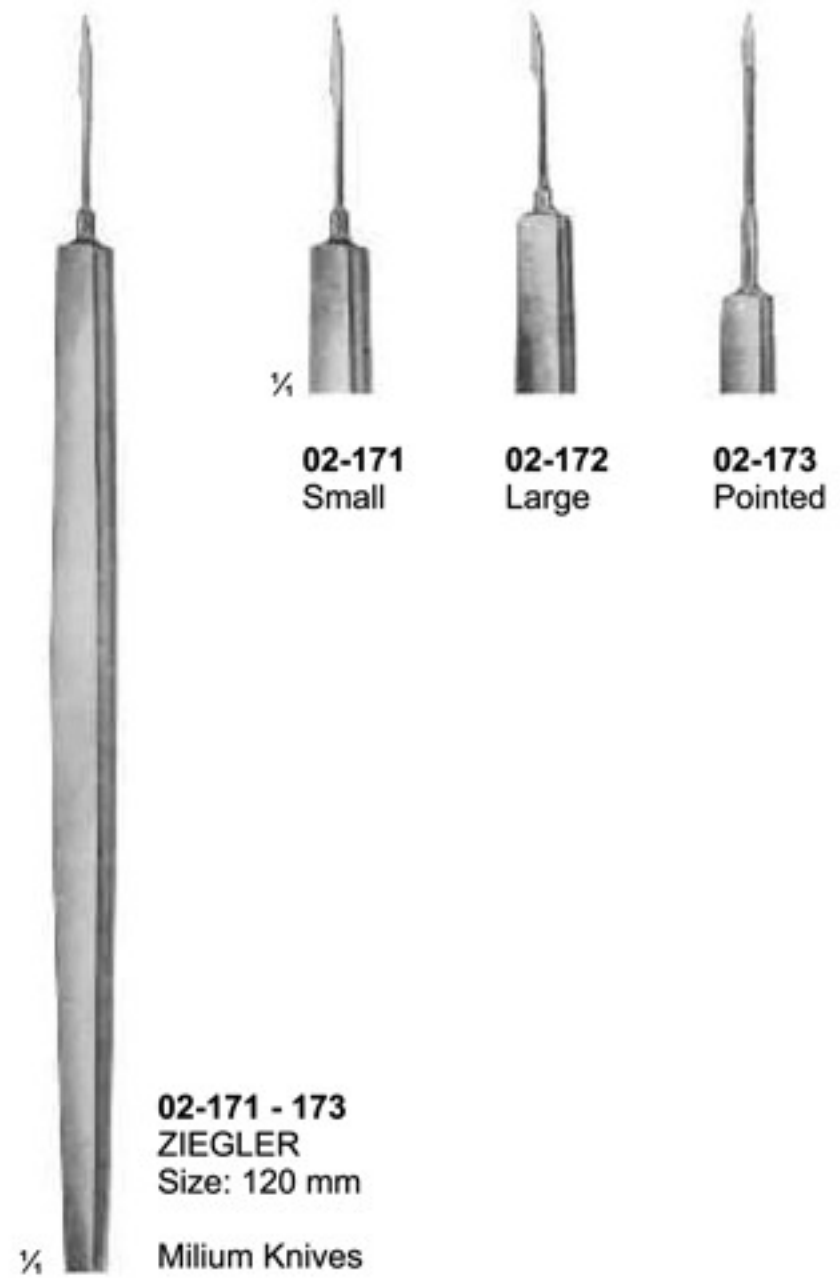

02-171
Small

02-172
Large

02-173
Pointed

02-171 - 173
ZIEGLER
Size: 120 mm

Milium Knives



02-174
VIDAL
Lupus Scraper
Size: 135 mm



02-175
MONCORPS
Milium Knives
Size: 130 mm

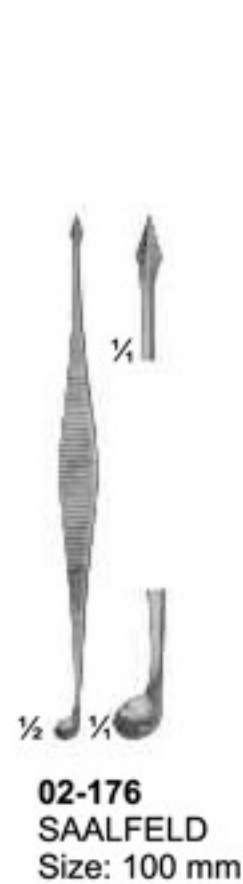

02-176
SAALFELD
Size: 100 mm

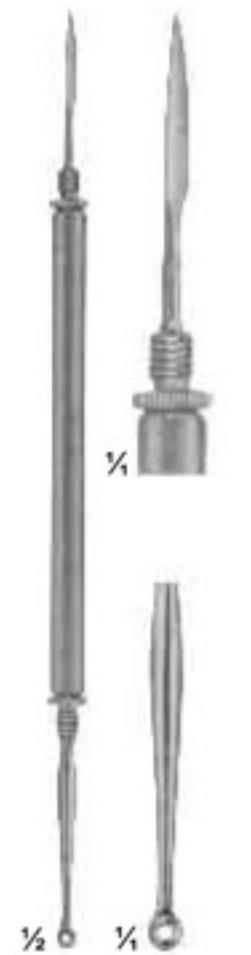

02-177
HEBRA
Size: 180 mm



02-178
Size: 145 mm



02-179
UNNA
Size: 145 mm

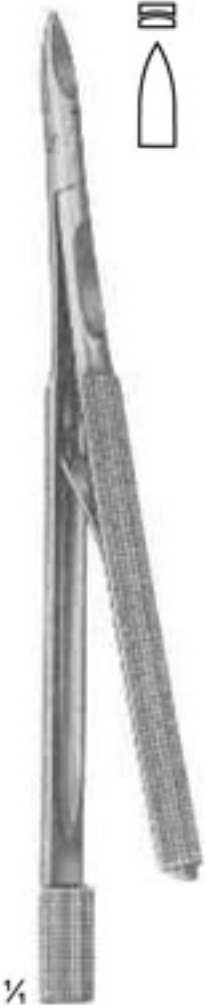

02-180
TROUTMAN-CHRIS
Size: 100 mm

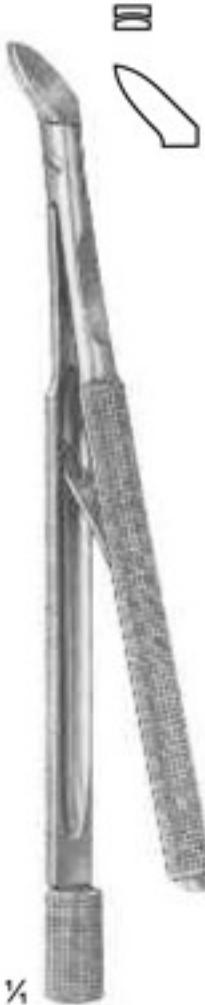

02-181
TROUTMAN-CHRIS
Size: 100 mm



02-182
Size: 110 mm



02-183
CASTROVIEJO
Size: 130 mm



02-184
Size: 185 mm

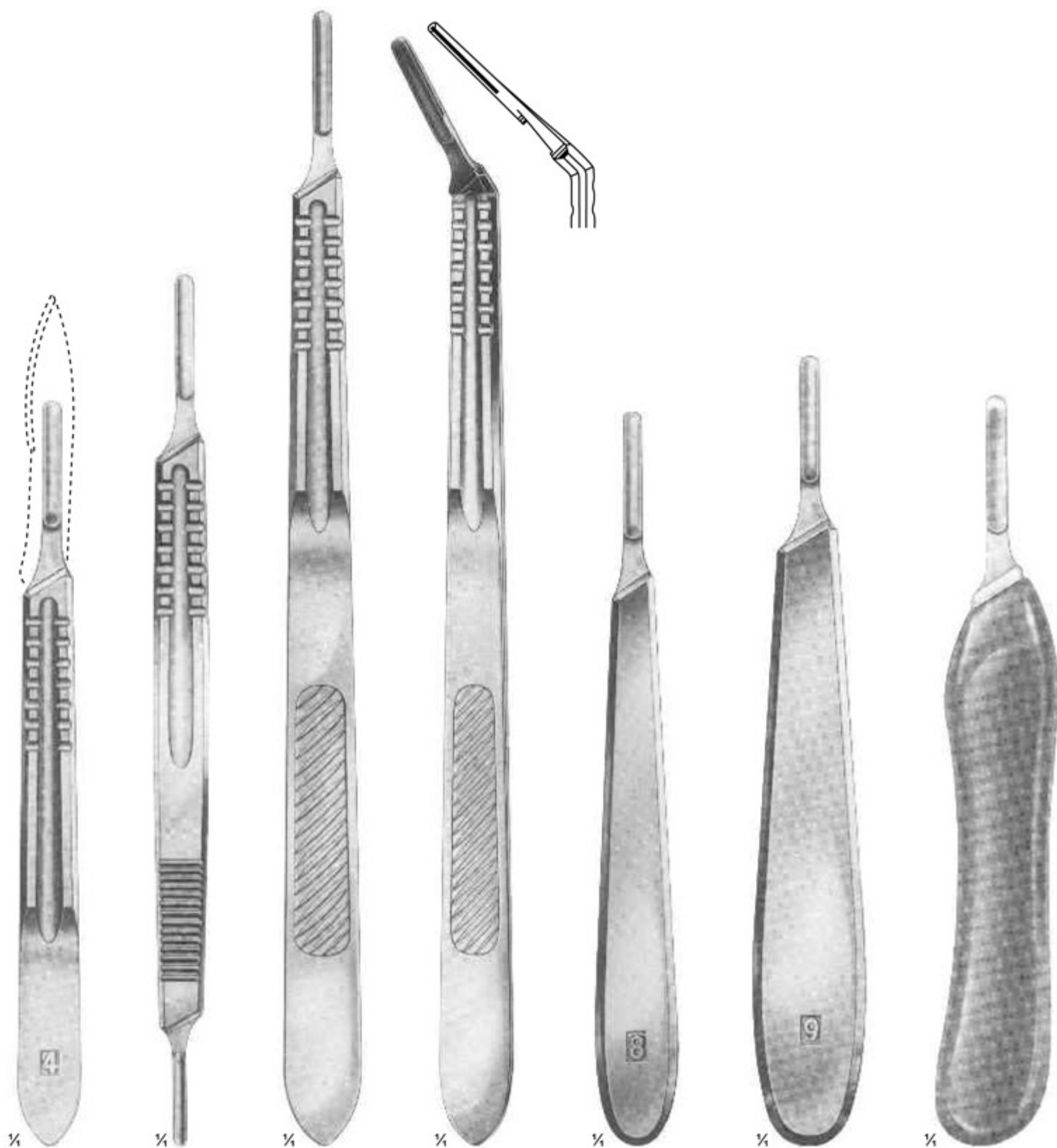

02-185
STANDARD
No. 4
Solid

02-186
Double Handel
No. 4 + No. 3
Solid

02-187
No. 4 L
Straight
Solid

02-188
No. 4 L
Solid Angled

02-189
COLLIN
No. 8
Hollow

02-190
COLLIN
No. 9
Hollow

02-191
Plastic

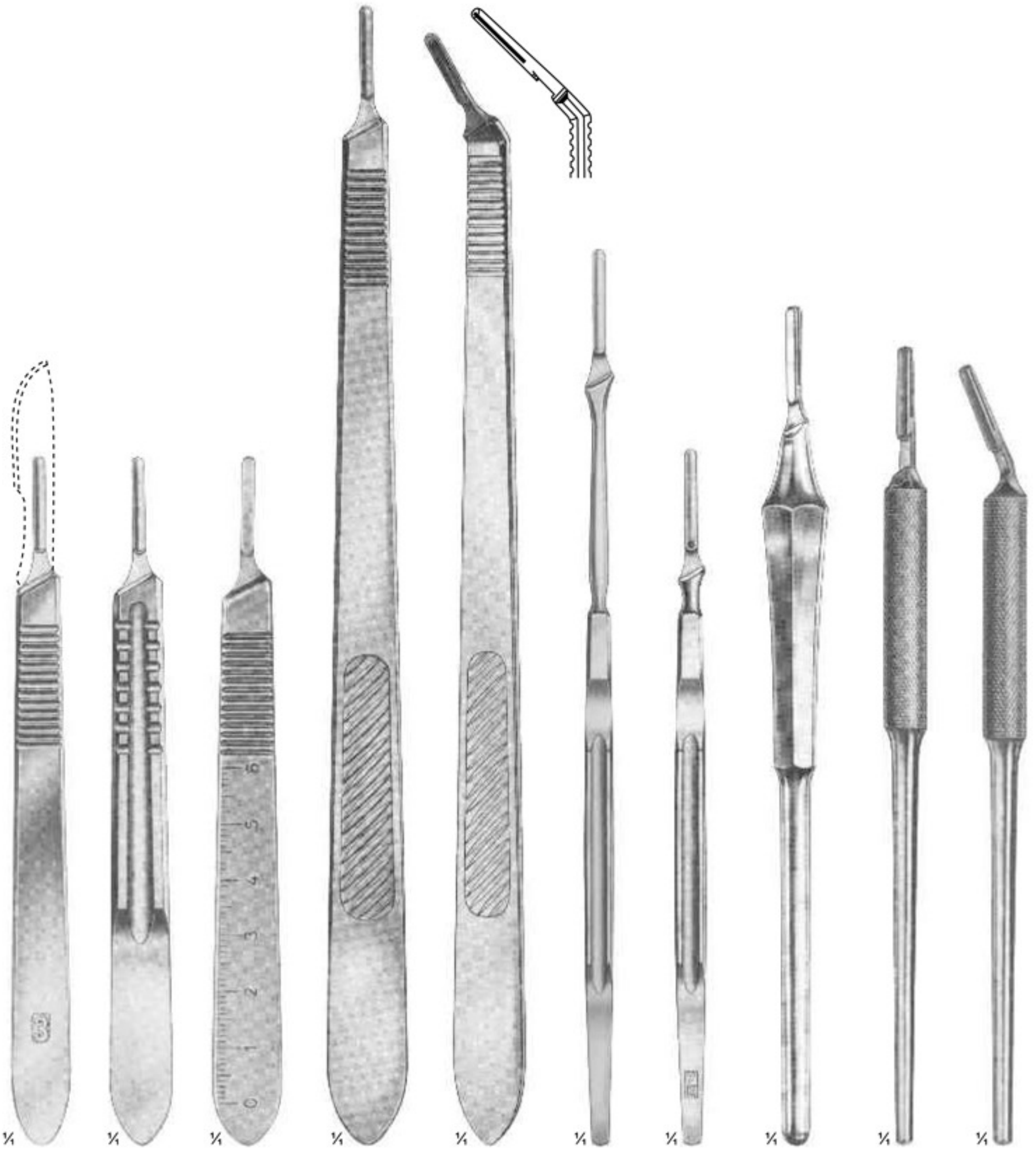

02-192 STANDARD No. 3 Solid	02-193 No. 3 Solid	02-194 No. 3 Solid	02-195 No. 3 L Straight Solid	02-196 No. 3 L Angled Solid	02-197 No. 7 Solid	02-198 No. 7 K Solid	02-199 Hollow-Round	02-200 No. 3 Straight Solid	02-201 No. 3 Angled Solid
---	---------------------------------	---------------------------------	---	---	---------------------------------	-----------------------------------	-------------------------------	---	---

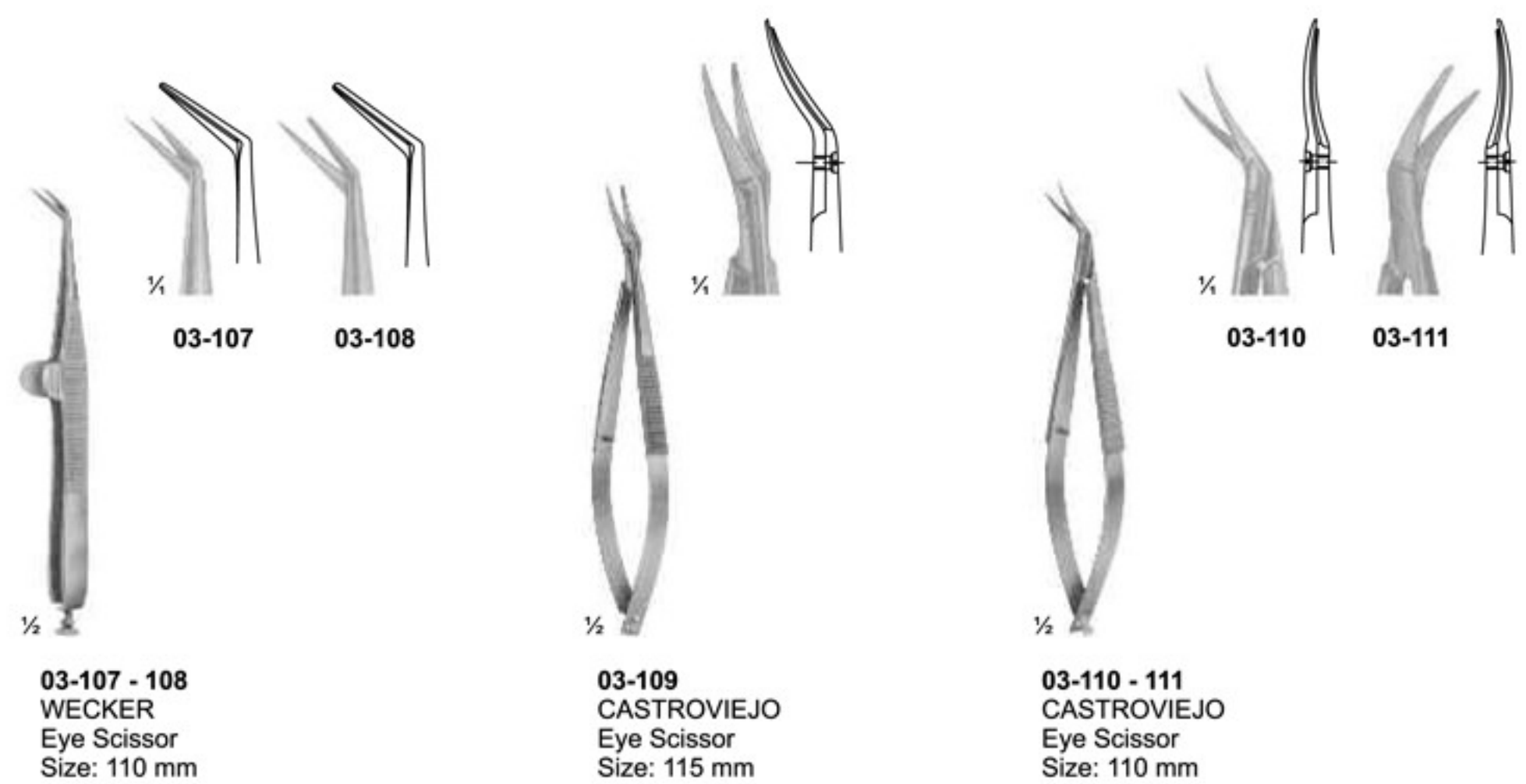
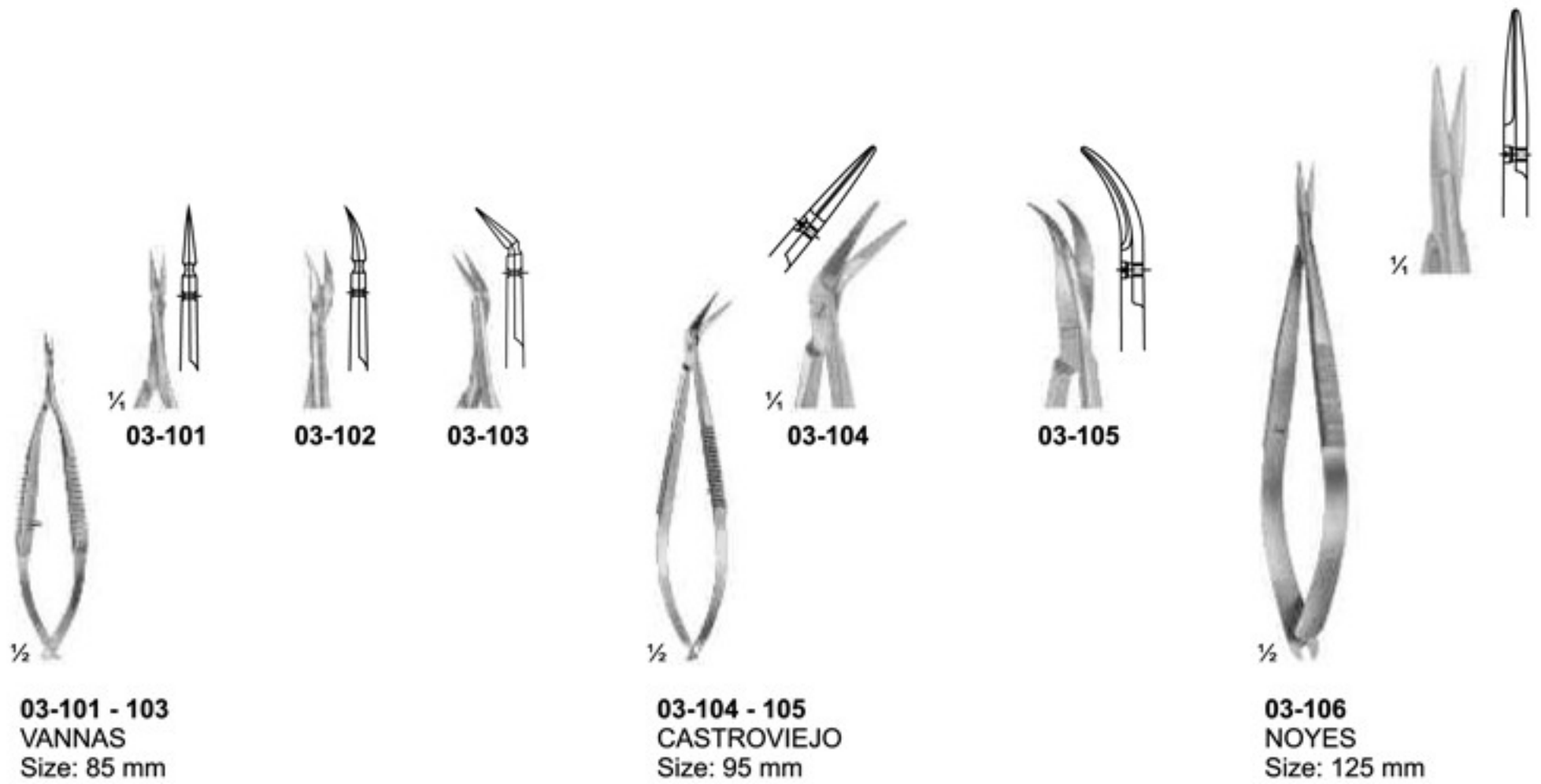

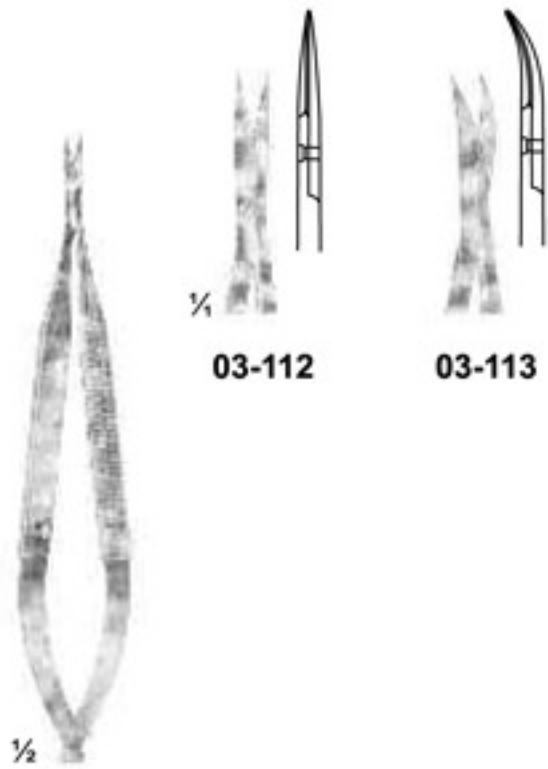

03-112 03-113

03-112 - 113
Size: 120 mm

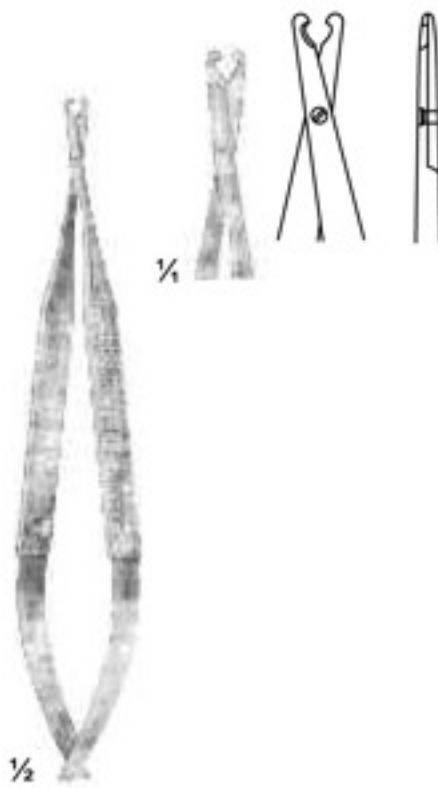

03-114
BIEMER
Vein Scissor
Size: 130 mm

03-115
Size: 160 mm

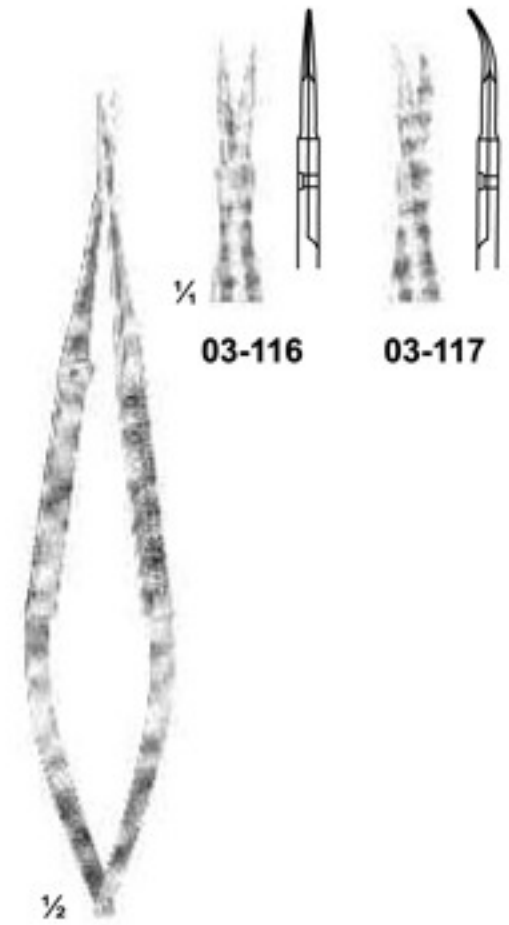

03-116 03-117

03-116 - 117
VANNAS
Size: 160 mm

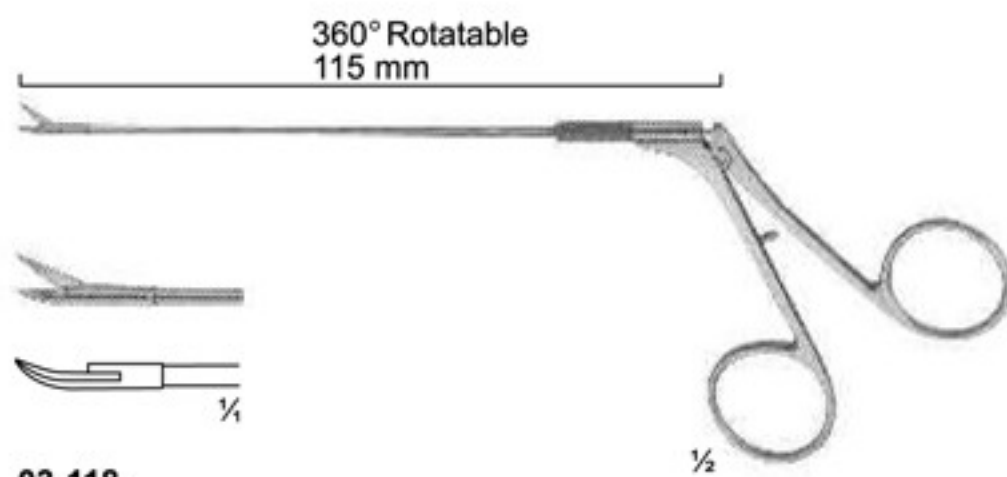

03-118
CASPAR
Micro Scissor Curved
Size: 115 mm

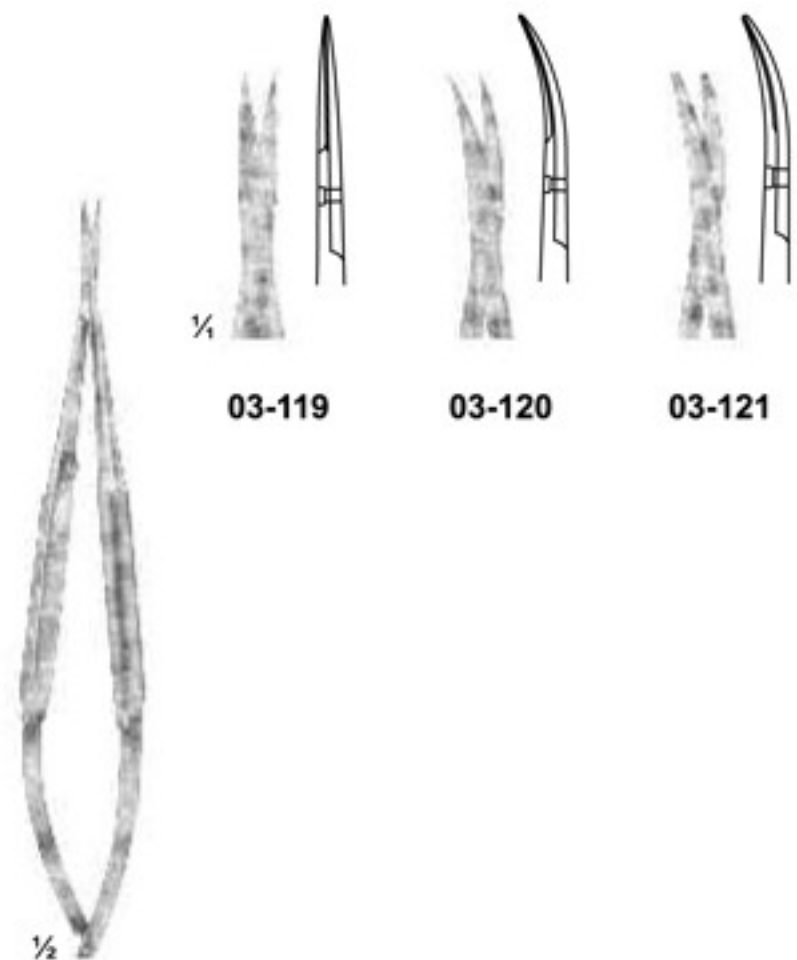

03-119 03-120 03-121

03-119 - 121
Micro Dissecting Scissor
Size: 145 mm



03-122
YASARGIL
Size: 245 mm

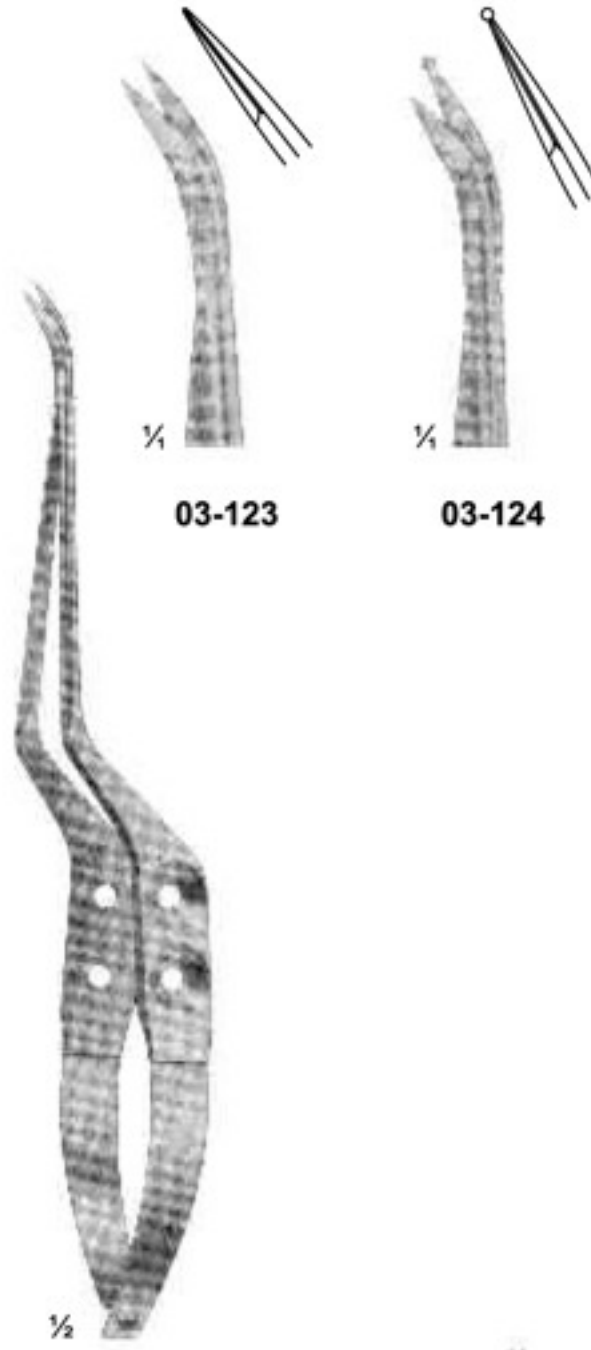

03-123

03-124

03-123 - 124
Laterally Angled
Size: 200 mm



03-125
Laterally Angled
Size: 190 mm

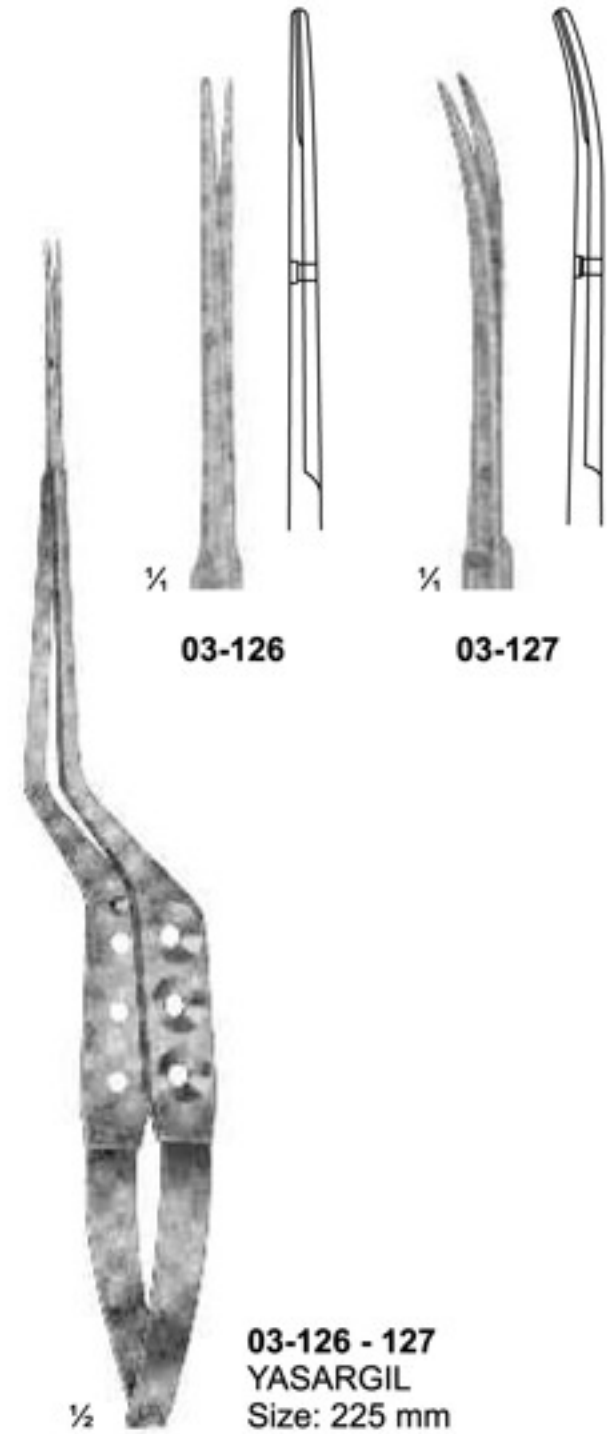

03-126

03-127

03-126 - 127
YASARGIL
Size: 225 mm

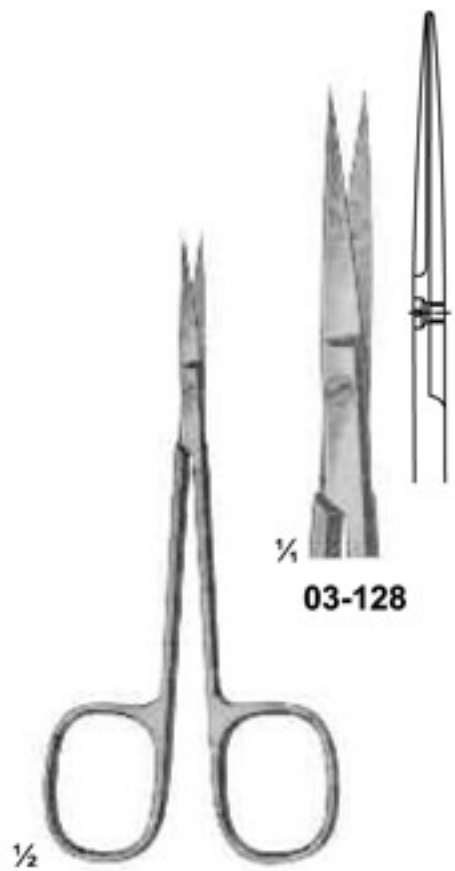

1/4
03-128



03-129

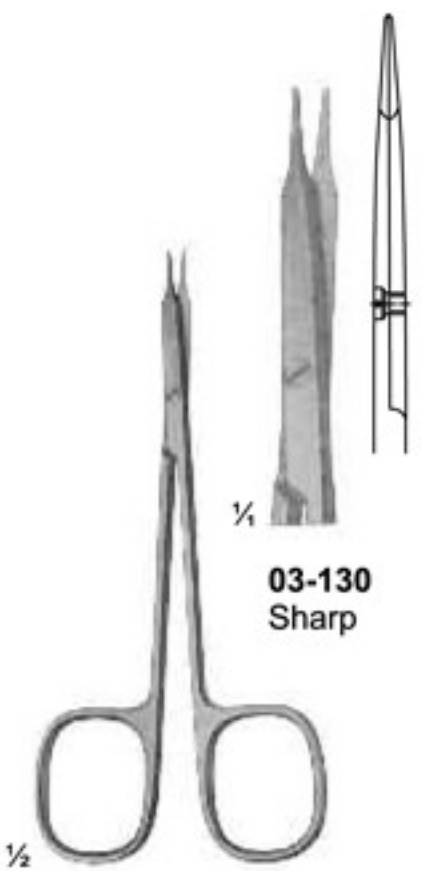

1/4
03-130
Sharp



03-131
Sharp



03-132
Blunt

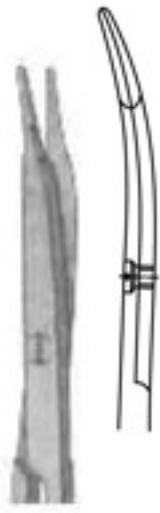

03-133
Blunt

03-128 - 129
Size: 120 mm

03-130 - 133
STEVENS
Dissecting Scissors
Size: 115 mm

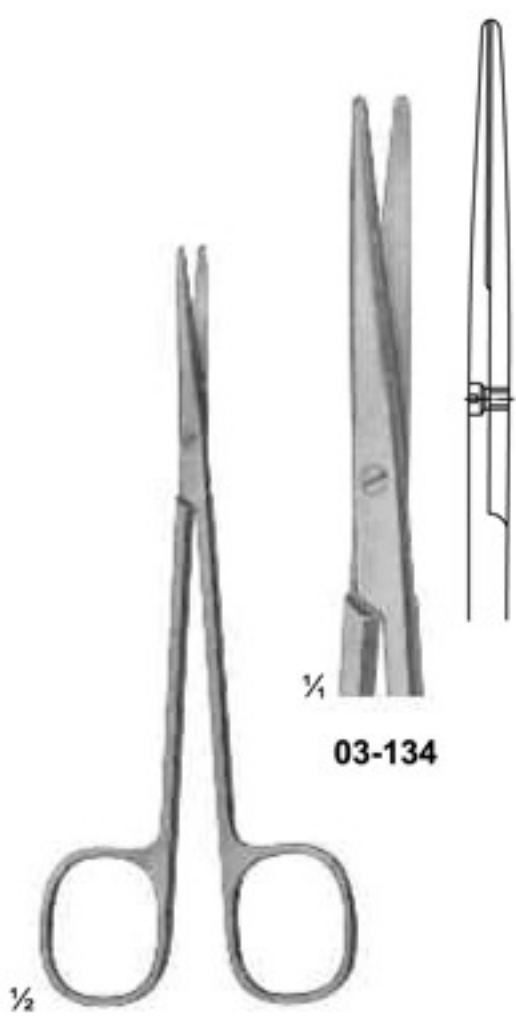

1/4
03-134



03-135

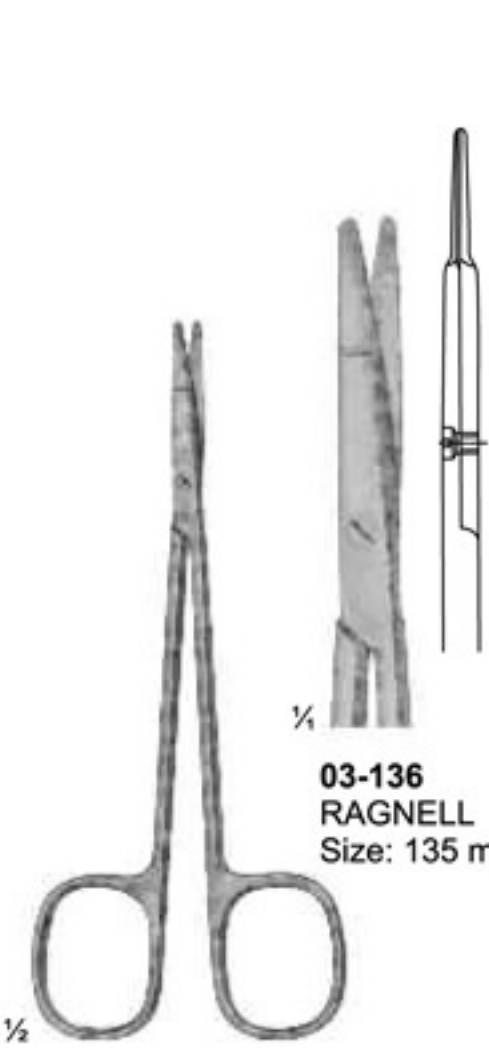

1/4
03-136
RAGNELL
Size: 135 mm

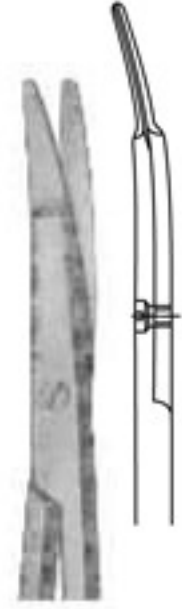

03-137
RAGNELL
Size: 135 mm

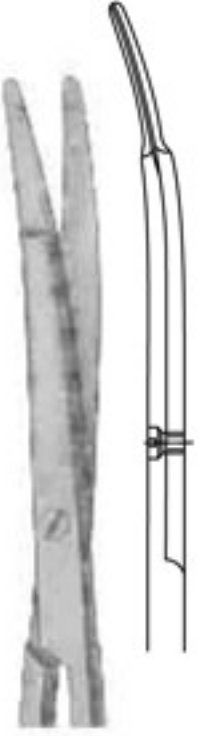

03-138
Size: 150 mm

03-134 - 135
METZENBAUM
Dissecting Scissors
Size: 145 mm

03-136 - 138
Special flat points for
dissecting and
undermining the skin
Size: 145 mm

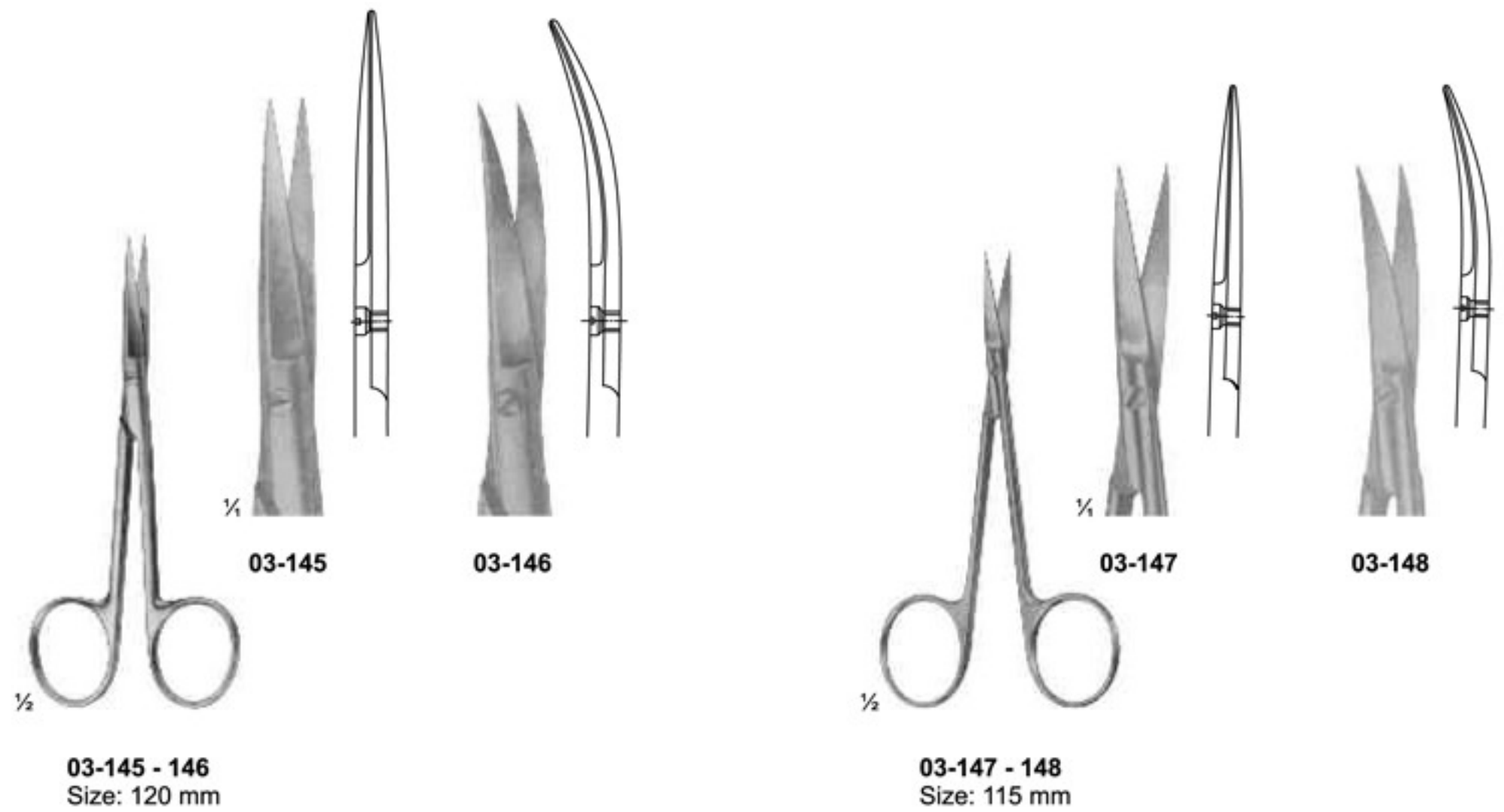
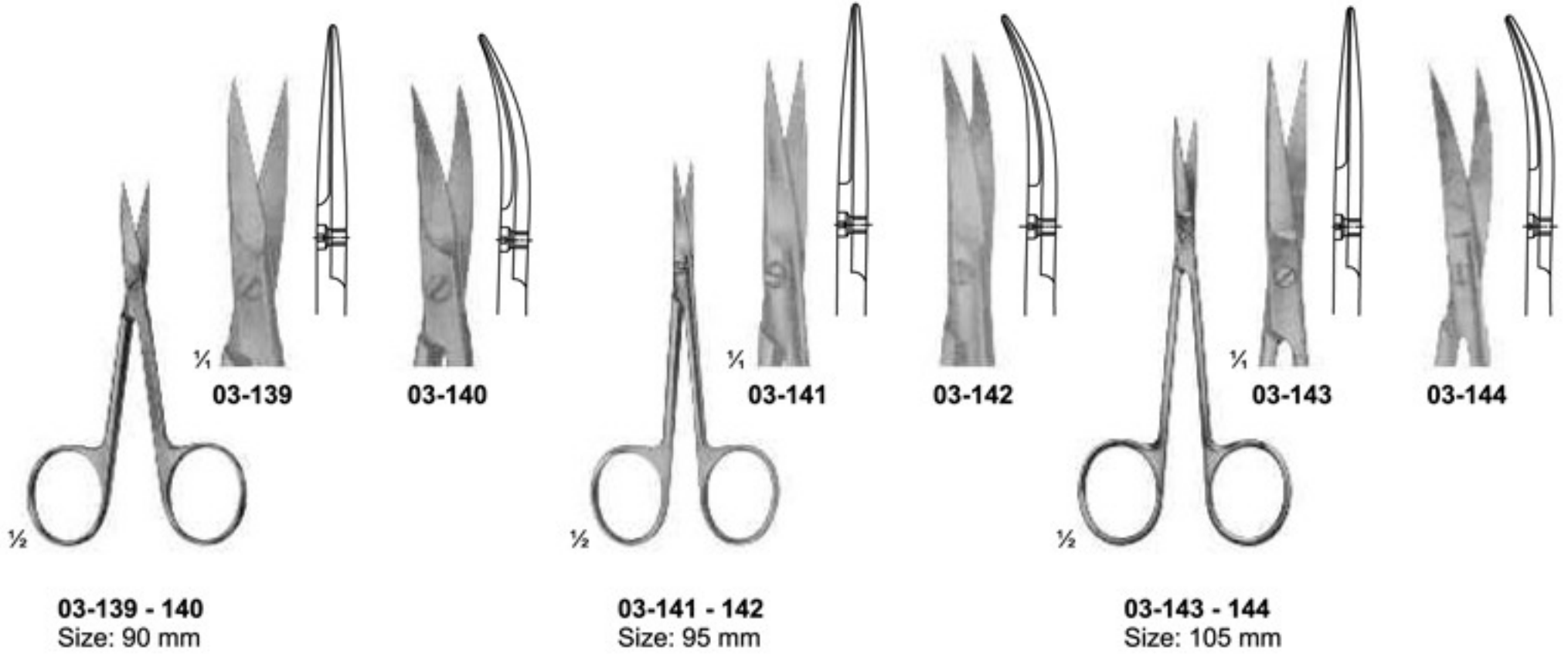



03-149 - 151
Size: 120 mm



03-149



03-150

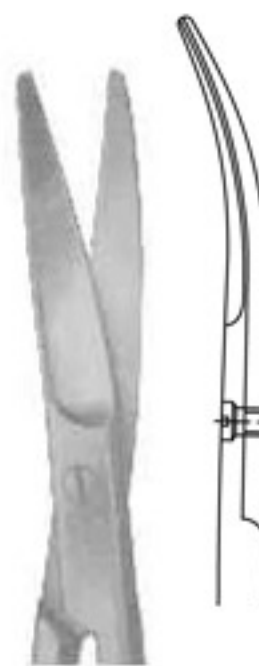

03-151

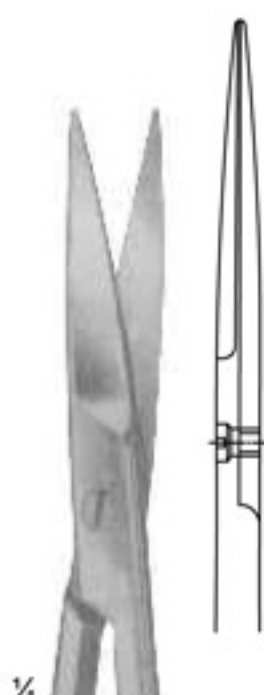

03-152



03-153

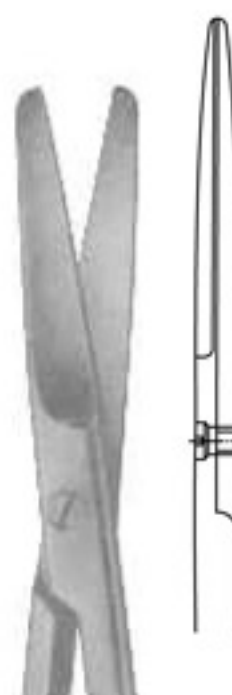

03-154

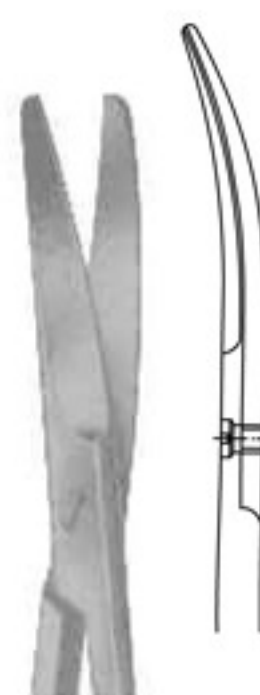

03-155



03-152 - 155
Size: 130 mm

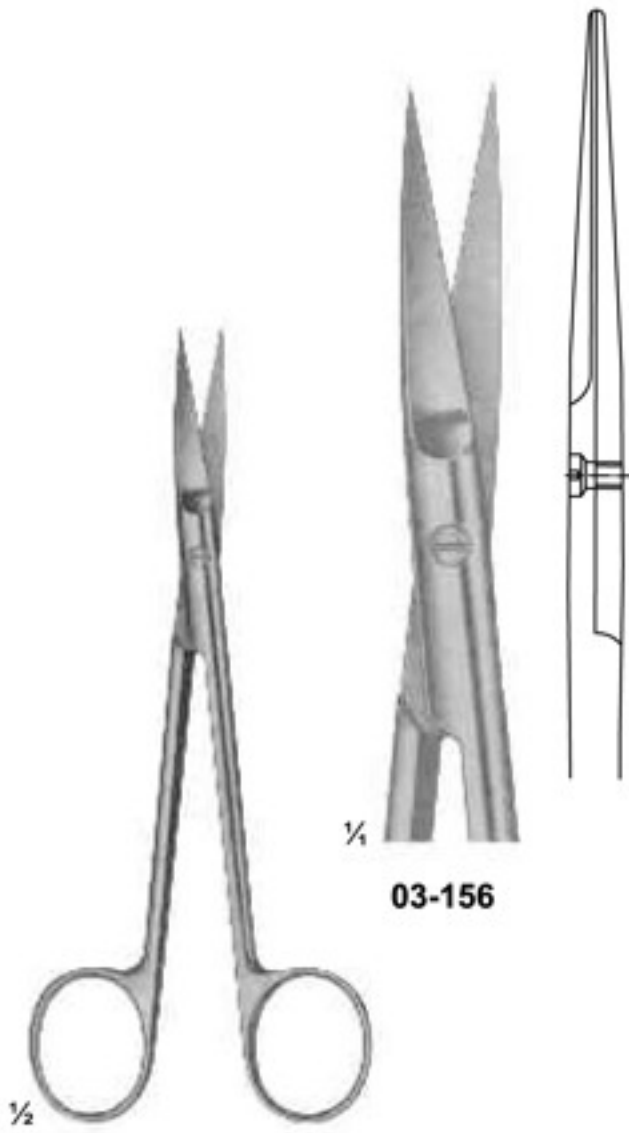

03-156 - 157
JOSEPH
Size: 150 mm

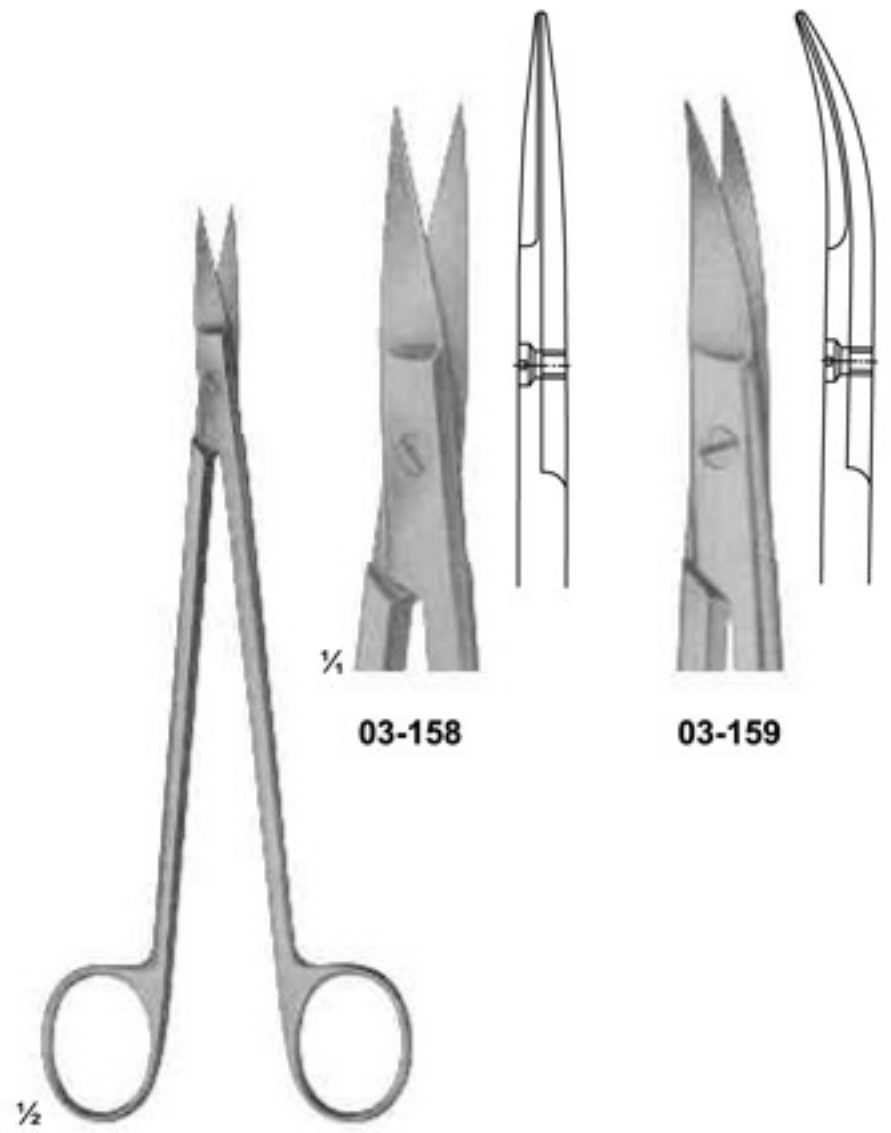

03-158 - 159
KELLY
Size: 175 mm

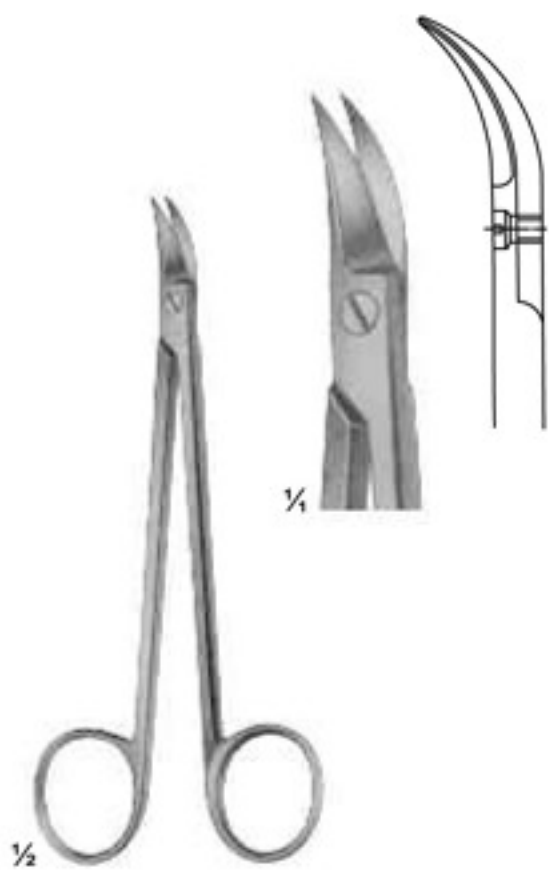

03-160
QUINBY
Size: 130 mm

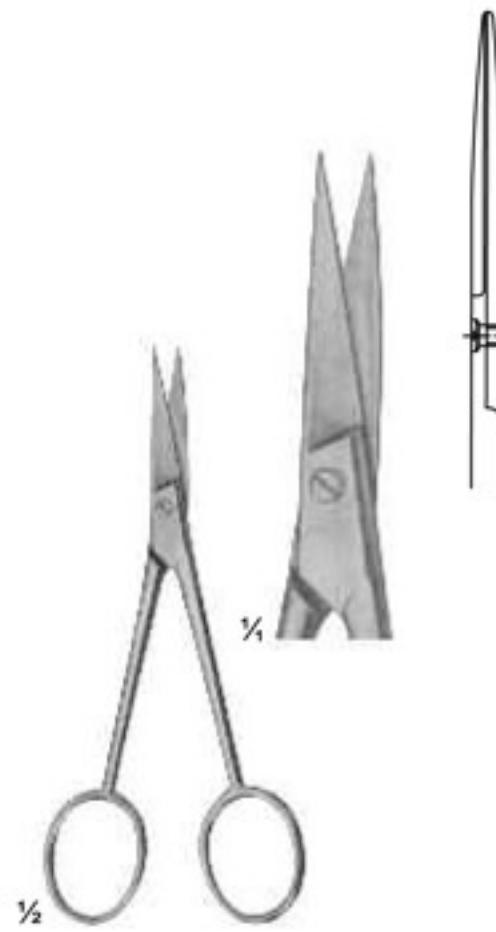

03-161
Size: 110 mm

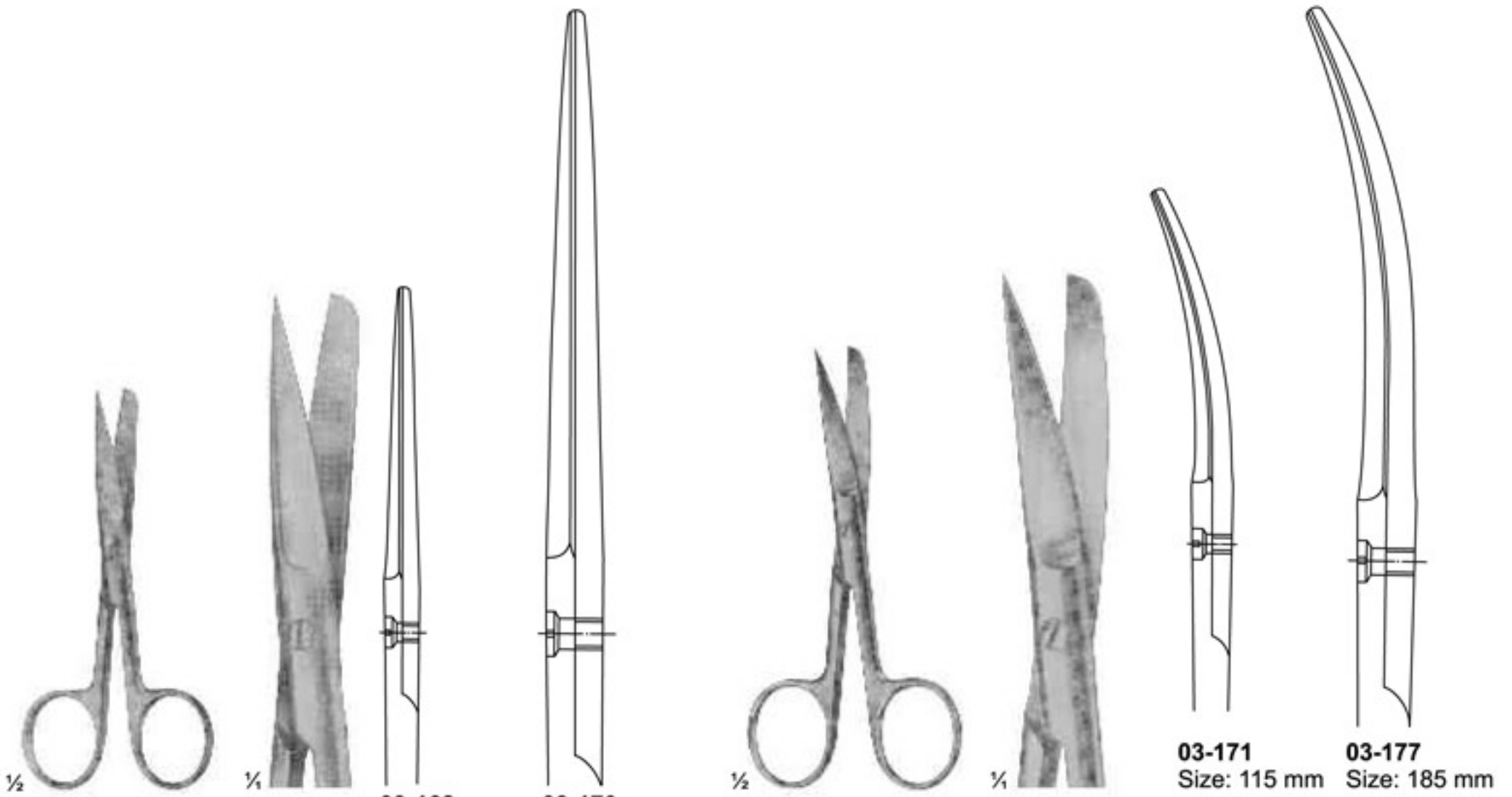

03-162 - 170 (Standard Types)
 03-162 (105 mm)
 03-163 (115 mm)
 03-164 (130 mm)
 03-165 (145 mm)
 03-166 (150 mm)
 03-167 (165 mm)
 03-168 (175 mm)
 03-169 (185 mm)
 03-170 (200 mm)

03-171 - 177 (Standard Types)
 03-171 (115 mm)
 03-172 (130 mm)
 03-173 (145 mm)
 03-174 (150 mm)
 03-175 (165 mm)
 03-176 (175 mm)
 03-177 (185 mm)

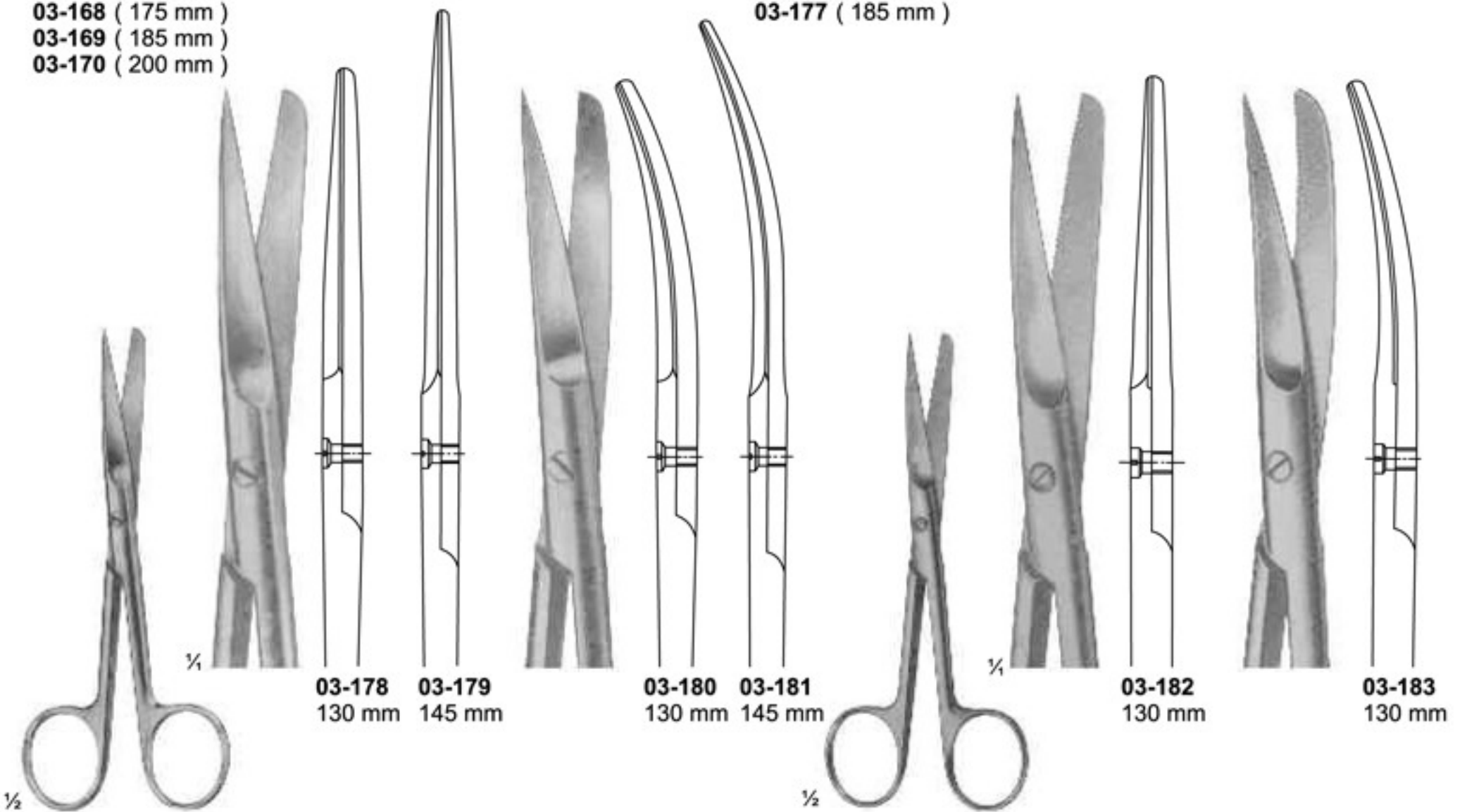

03-178 - 181
 Slender Types

03-182 - 183
 For Wound Edges
 1 Blade Serrated

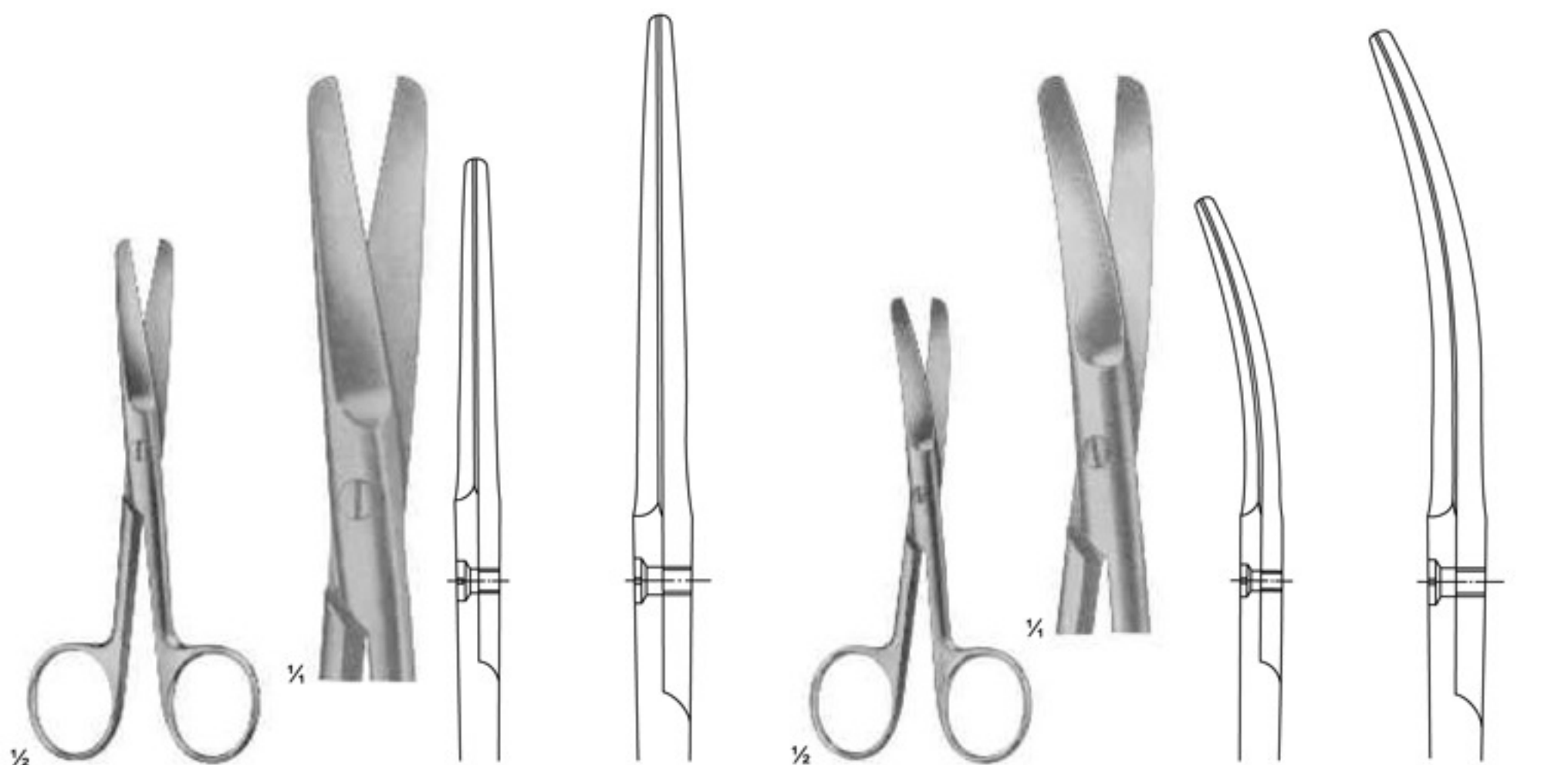

03-184 - 188 (Standard Types)
03-184 (130 mm)
03-185 (145 mm)
03-186 (150 mm)
03-187 (165 mm)
03-188 (175 mm)

03-184 **03-188**
 Size: 130 mm Size: 175 mm

03-189 - 194 - COOPER
 Standard Types
03-189 (115 mm)
03-190 (130 mm)
03-191 (145 mm)
03-192 (150 mm)
03-193 (165 mm)
03-194 (175 mm)

03-189 **03-194**
 Size: 115 mm Size: 175 mm

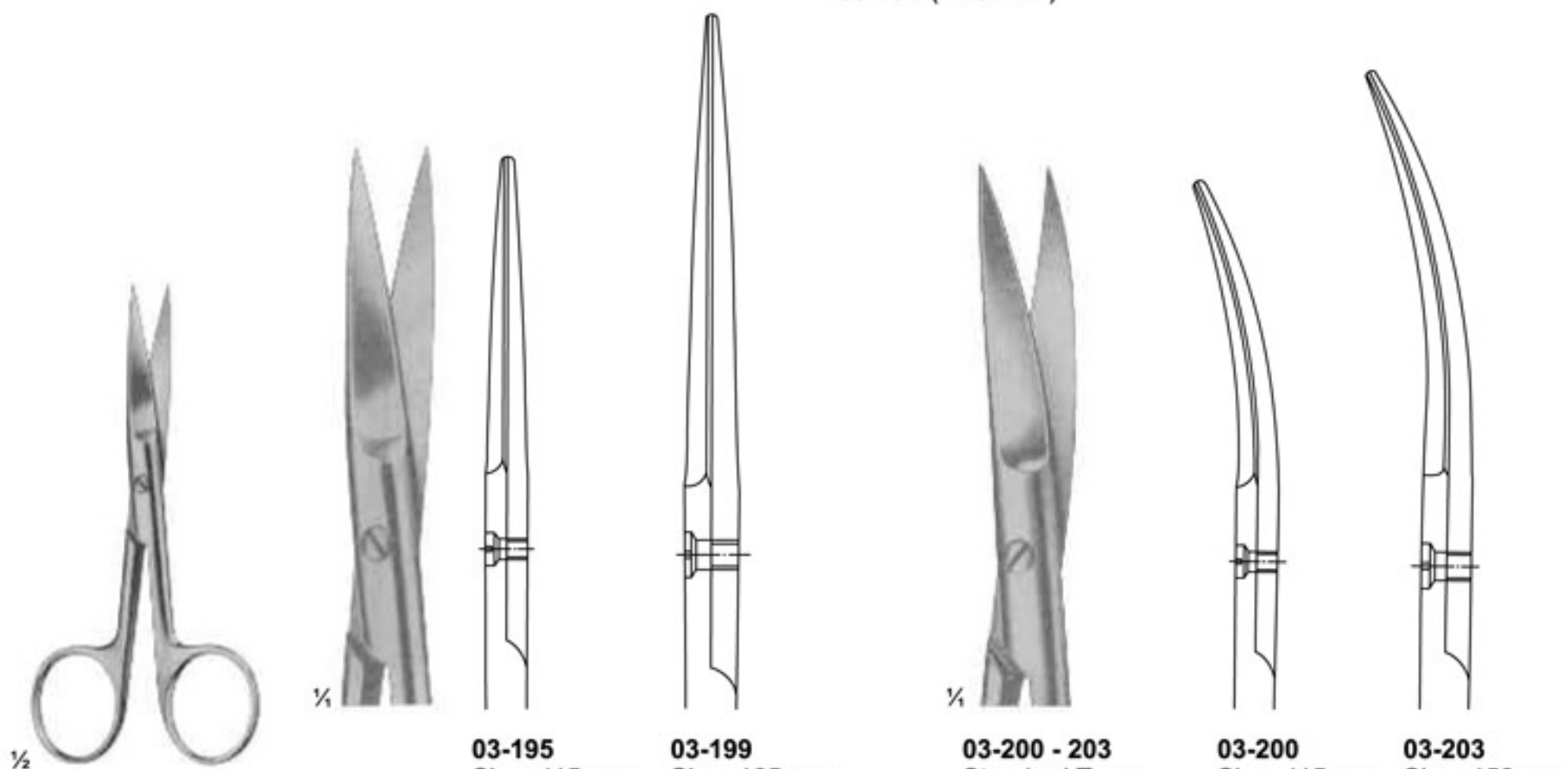

03-195 - 199
 Standard Types
03-195 (115 mm)
03-196 (130 mm)
03-197 (145 mm)
03-198 (150 mm)
03-199 (165 mm)

03-195 **03-199**
 Size: 115 mm Size: 165 mm

03-200 - 203
 Standard Types
03-200 (115 mm)
03-201 (130 mm)
03-202 (145 mm)
03-203 (150 mm)

03-200 **03-203**
 Size: 115 mm Size: 150 mm



03-204 - 206
DEAVER
With flat lock

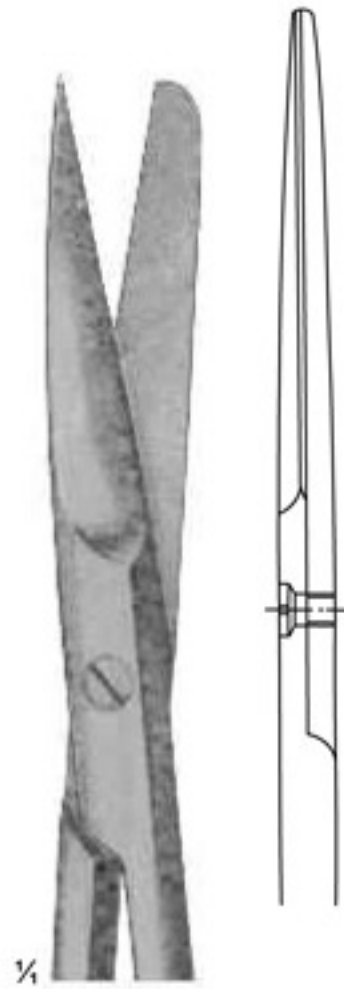

03-204
Size: 145 mm

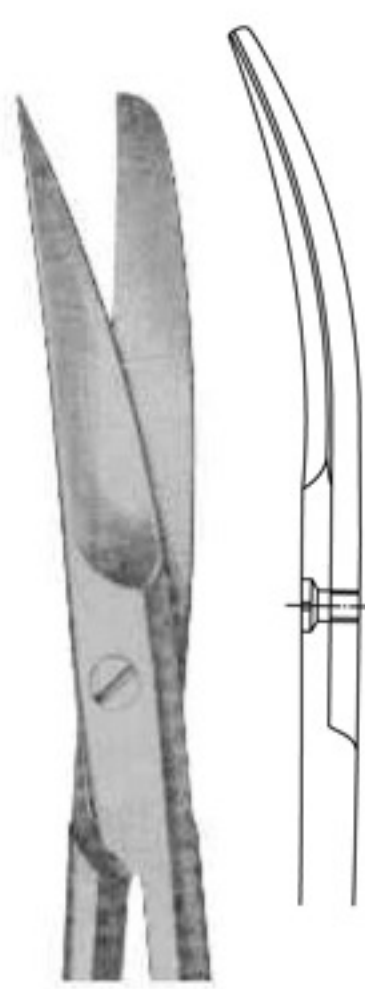

03-205
Size: 145 mm

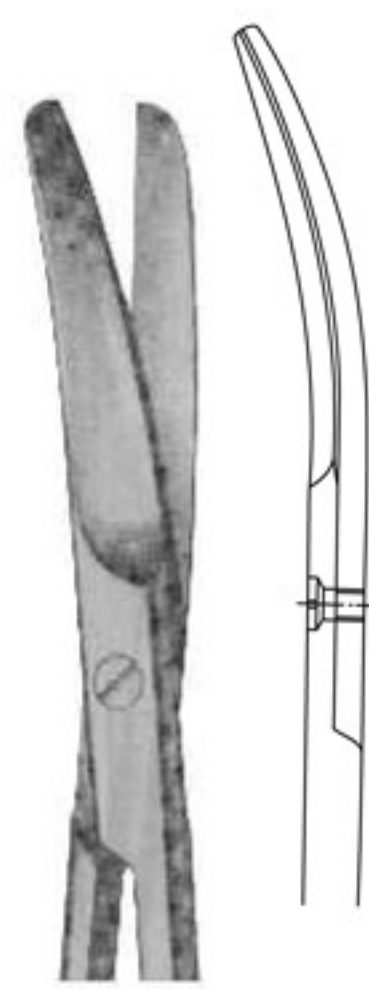

03-206
Size: 145 mm



03-207 - 209
Incision Scissors

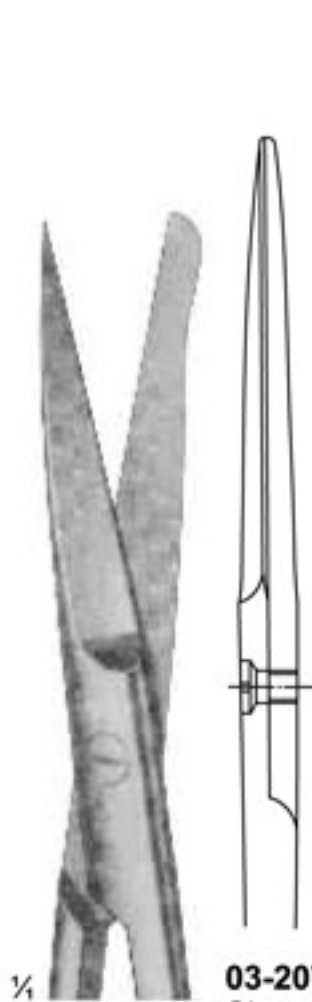

03-207
Size: 130 mm



03-208
Size: 145 mm



03-209
Size: 165 mm

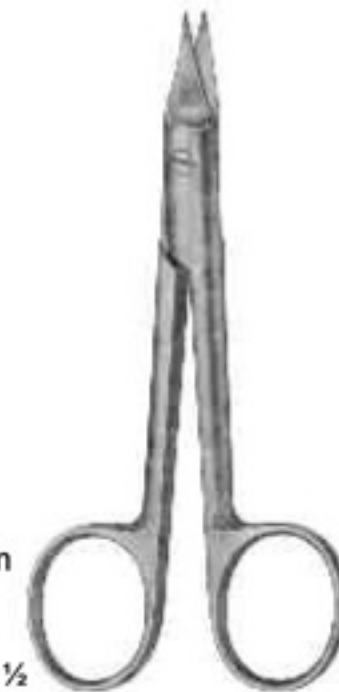

03-210
SYSTRUNK
Nail Splitting Scissors

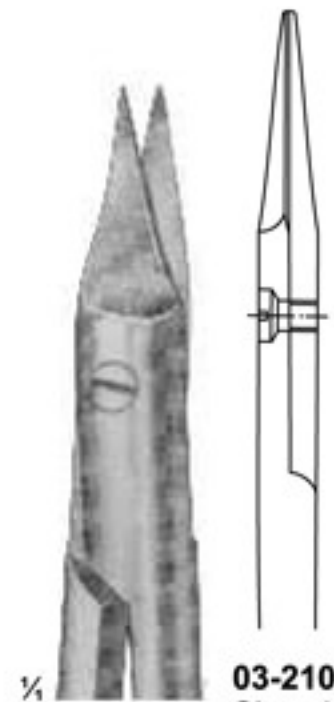

03-210
Size: 130 mm

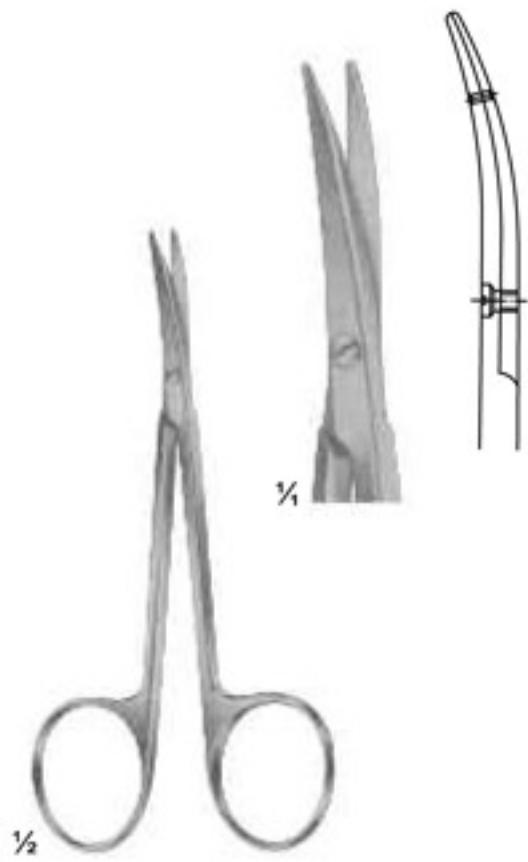

03-211
LITTLER
Dissecting Scissors
Tips with eye for suture
Size: 115 mm

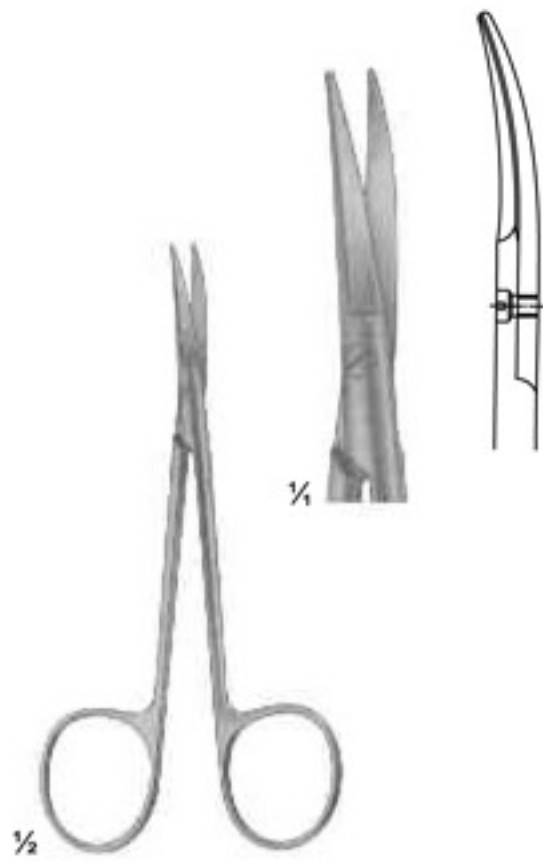

03-212
COTTLE
Bulldog Scissors
Size: 115 mm



03-213 **03-214**
Size: 100 mm Size: 100 mm

03-213 - 214
STEVENS
Vessel and tendon Scissors
Size: 100 mm

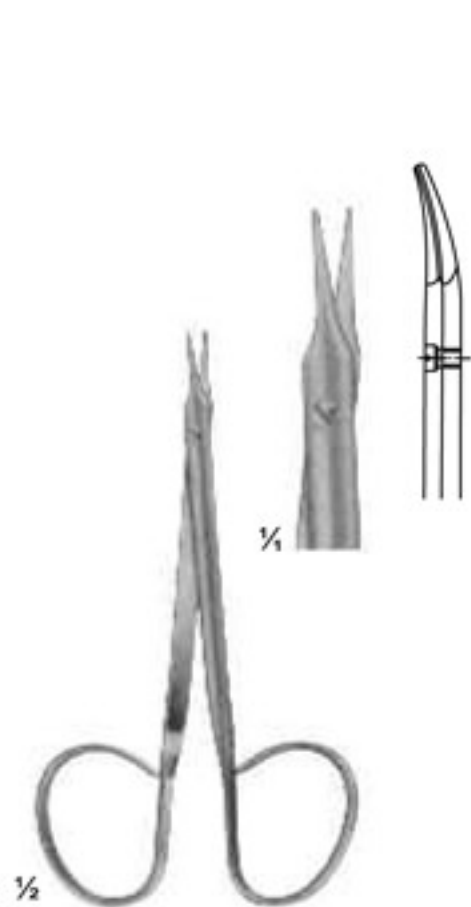

03-215
STEVENS
Fine Dissecting Scissors
Size: 110 mm

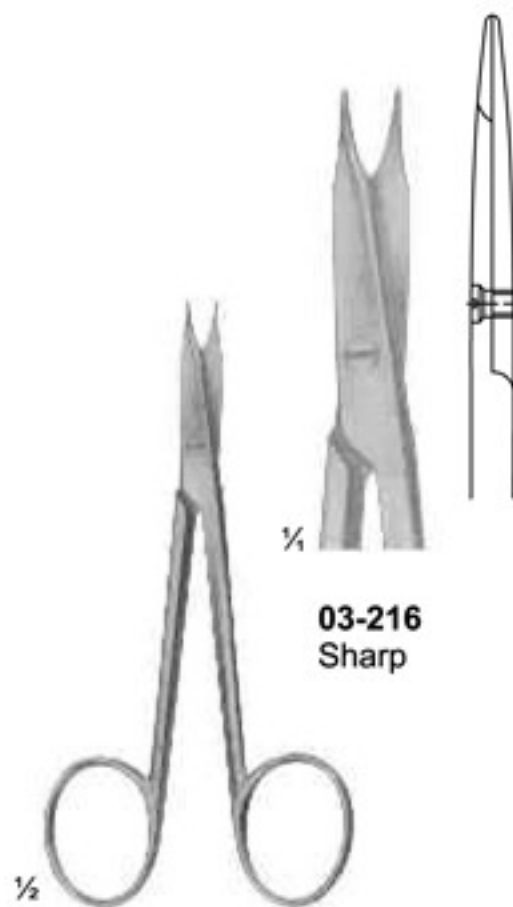

03-216
Sharp

03-216 - 219
STEVENS
Vessel and tendon Scissors
Size: 110 mm



03-217
Sharp

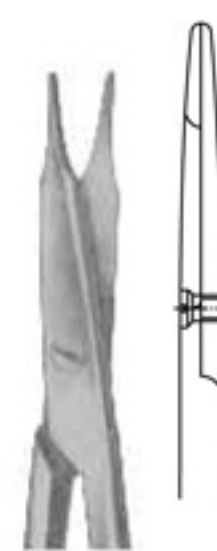

03-218
Blunt



03-219
Blunt

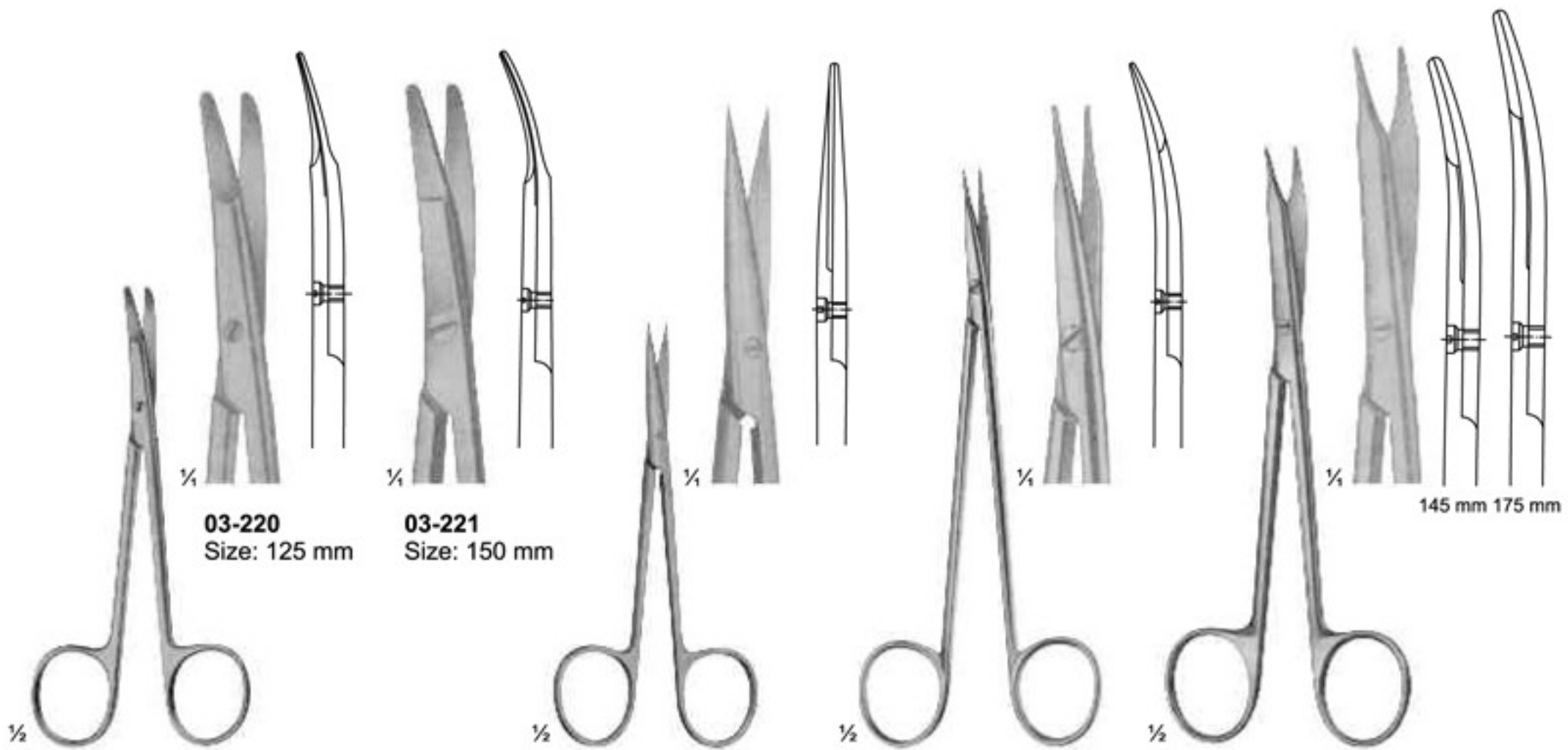

03-220 - 221
KILNER
 Special flat points for dissecting and undermining the skin

03-222
KILNER
 Fine dissecting scissors
 Size: 115 mm

03-223
JAMESON
 Dissecting scissors
 Size: 150 mm

03-224
REYNOLDS
 Dissecting scissors
 Size: 145 - 175 mm

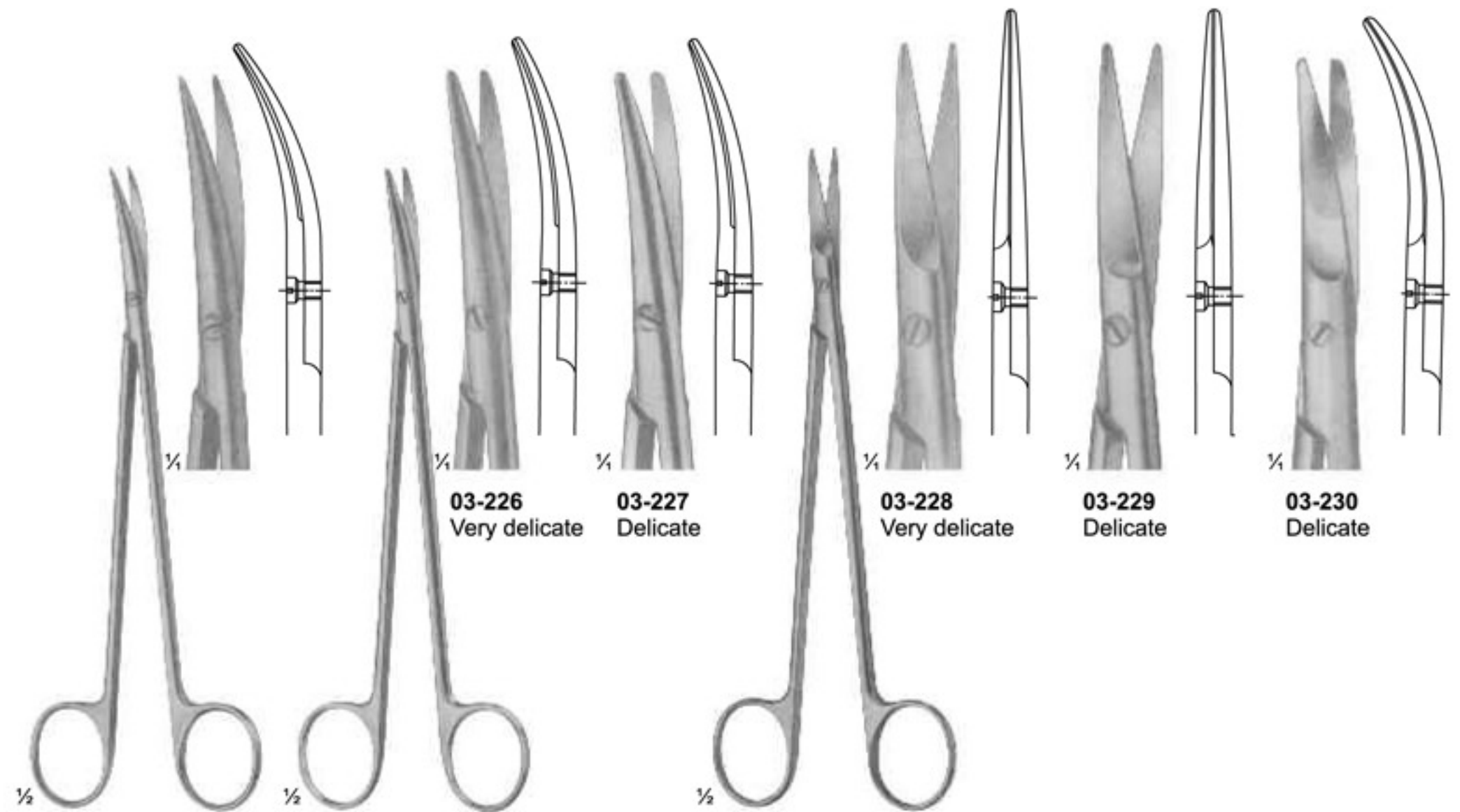

03-225
DE BAKEY
 Ateriectomy scissors
 Size: 175 mm

03-226 - 227
TOENNIS ADSON
 Dissecting scissors
 Size: 175 mm

03-228 - 230
TOENNIS
 Dissecting scissors
 Size: 150 mm

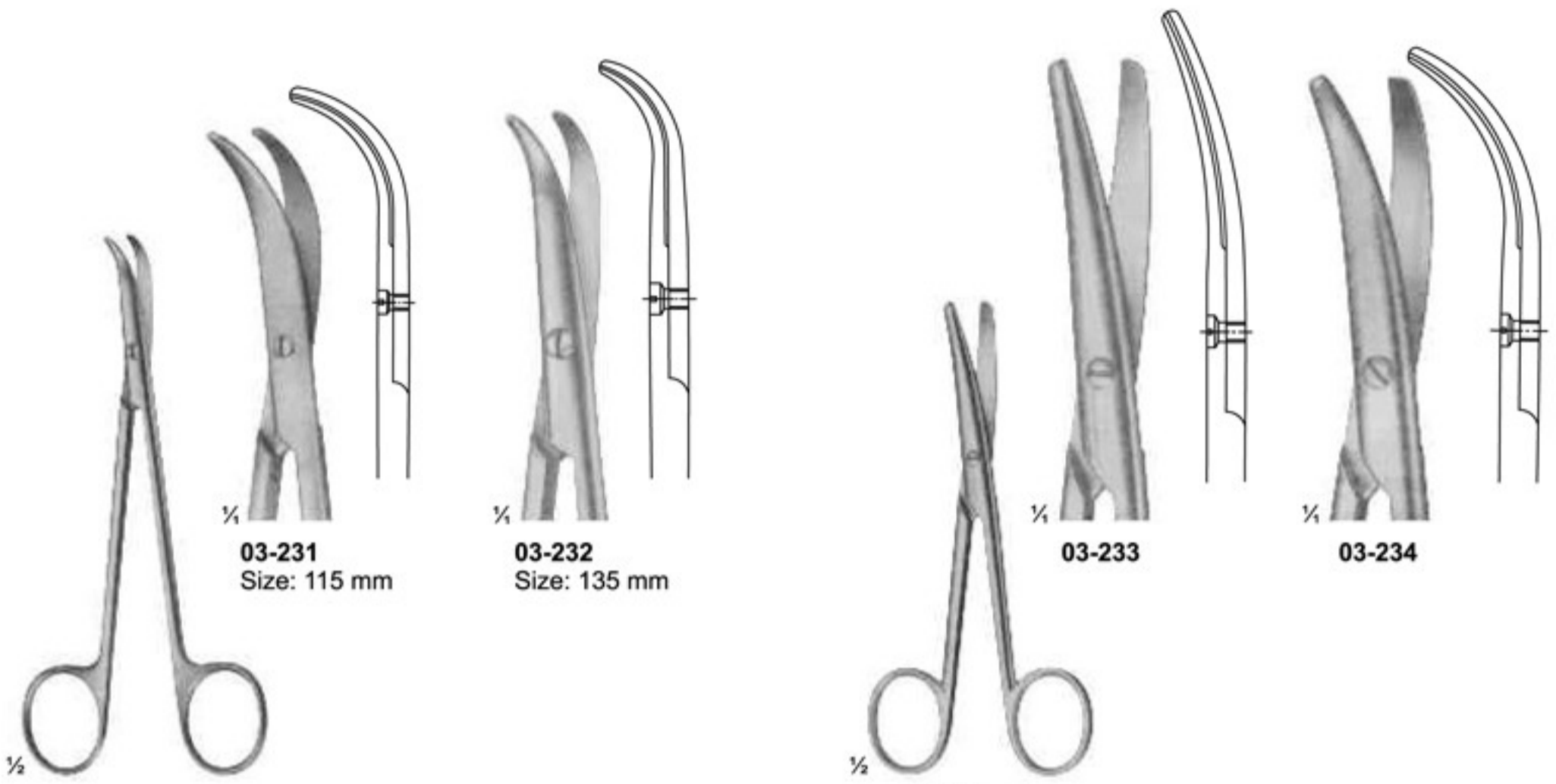

03-231
Size: 115 mm

03-232
Size: 135 mm

03-233

03-234

03-231 - 232
FOMON
Lower lateral scissors

03-233 - 234
LANDOLT
Enucleation scissors
Size: 120 mm

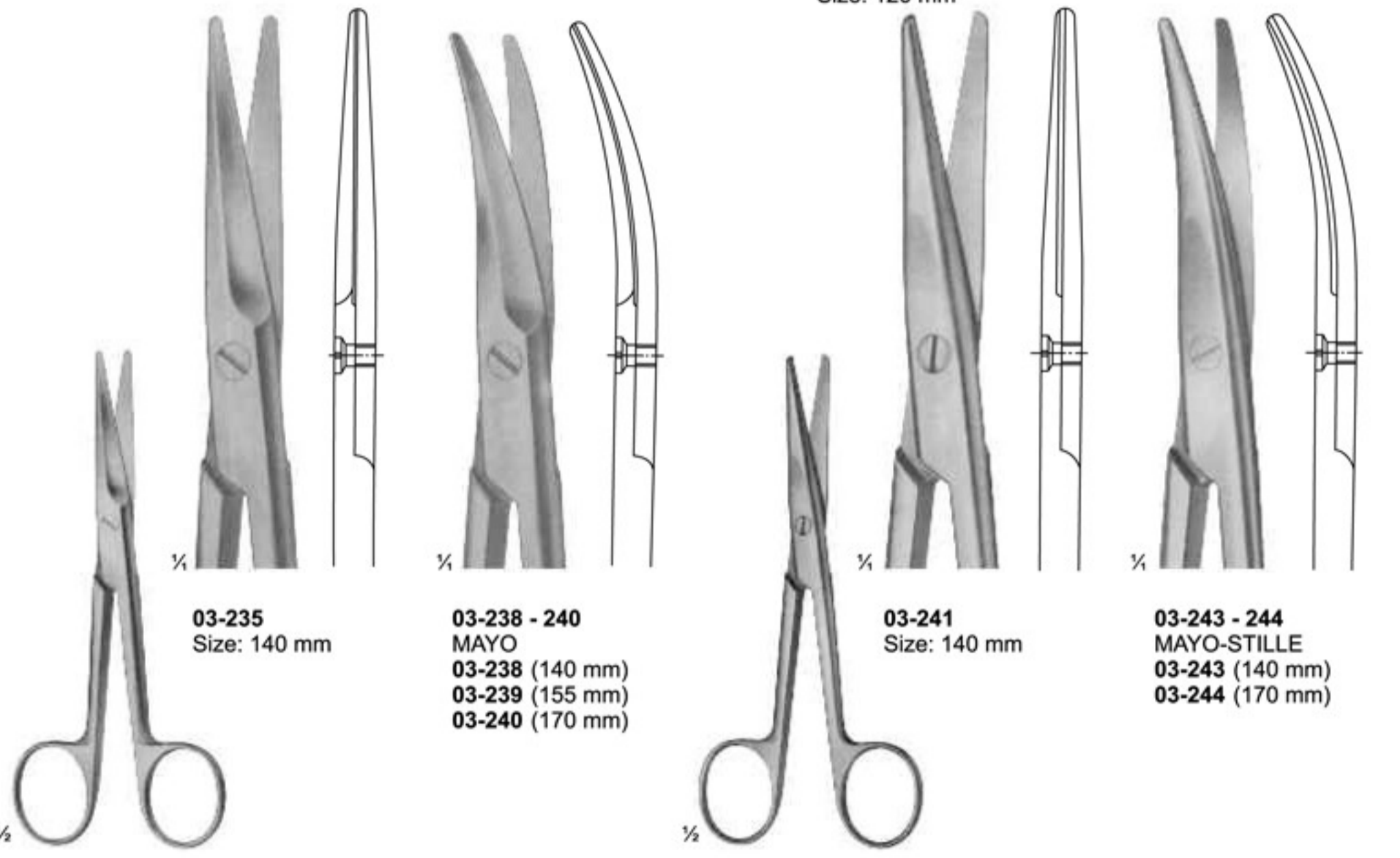

03-235
Size: 140 mm

03-238 - 240
MAYO
03-238 (140 mm)
03-239 (155 mm)
03-240 (170 mm)

03-241
Size: 140 mm

03-243 - 244
MAYO-STILLE
03-243 (140 mm)
03-244 (170 mm)

03-235 - 237
MAYO
03-235 (140 mm)
03-236 (155 mm)
03-237 (170 mm)

03-241 - 242
MAYO-STILLE
03-241 (140 mm)
03-242 (170 mm)

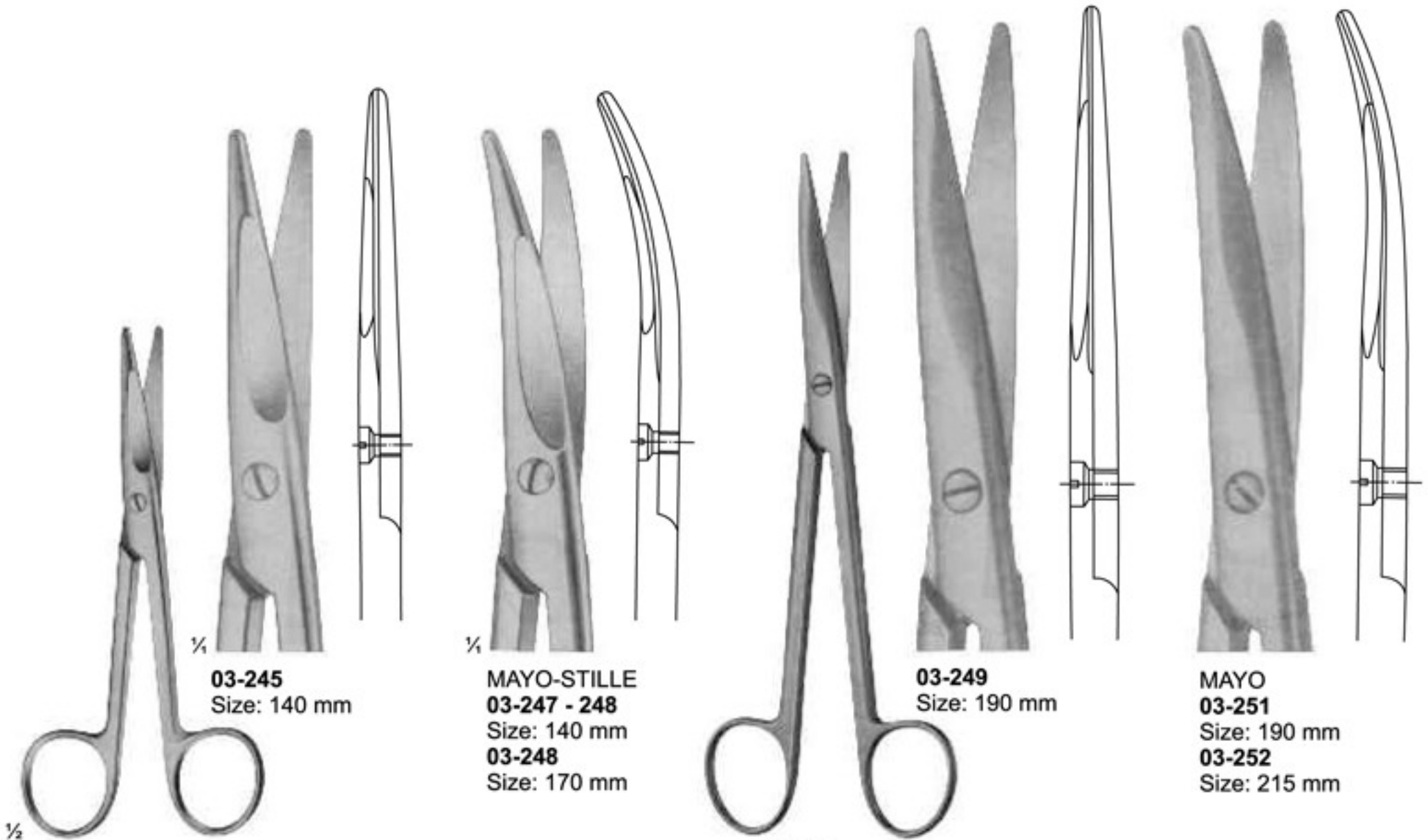

03-245
Size: 140 mm

MAYO-STILLE
03-247 - 248
Size: 140 mm
03-248
Size: 170 mm

03-249
Size: 190 mm

MAYO
03-251
Size: 190 mm
03-252
Size: 215 mm

03-245 - 246
MAYO-STILLE
With chamfered blades
03-245 (140 mm)
03-246 (170 mm)

MAYO
With chamfered blades
03-249 (190 mm)
03-250 (215 mm)

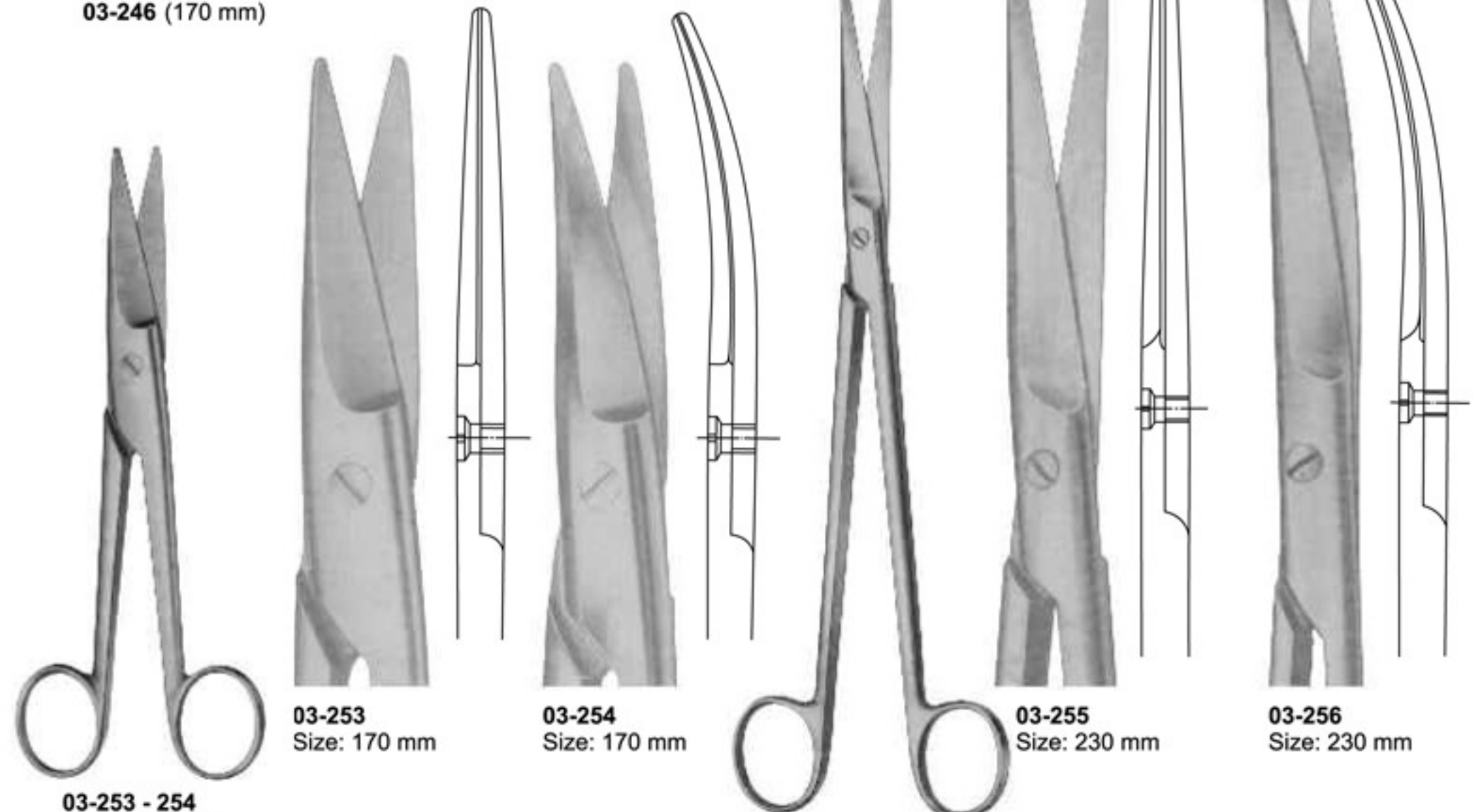

03-253
Size: 170 mm

03-254
Size: 170 mm

03-255
Size: 230 mm

03-256
Size: 230 mm

03-253 - 254
MAYO-NOBLE
Broad pattern

03-255 - 256
MAYO-HARRINGTON

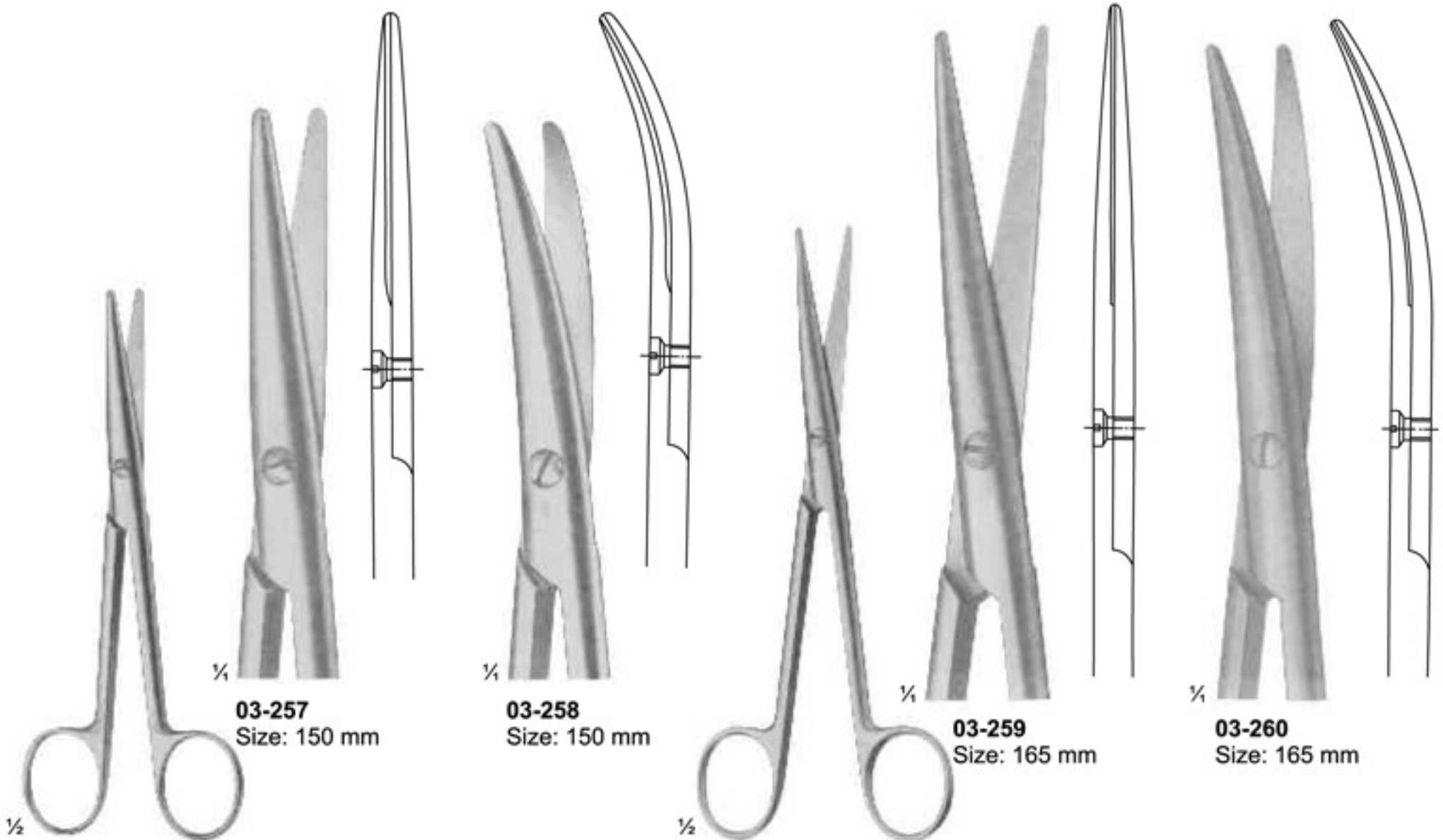

03-257
Size: 150 mm

03-258
Size: 150 mm

03-259
Size: 165 mm

03-260
Size: 165 mm

03-257 - 258
STILLE
Size: 150 mm

03-259 - 260
LEXER
Narrow
Size: 165 mm

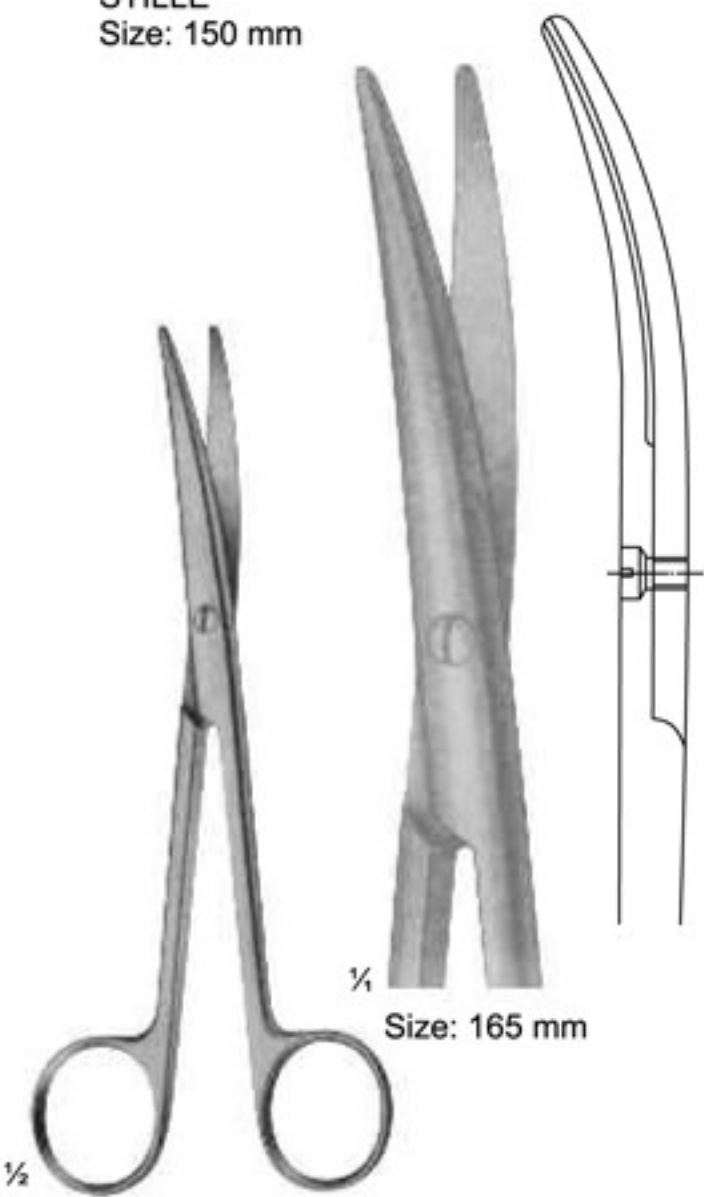

Size: 165 mm

03-262
Size: 165 mm

MAYO
03-264 - 266
Size: 165 mm

03-261
MAYO-LEXER
Standard

03-262 - 263
MAYO
03-262 (165 mm)
03-263 (200 mm)

03-265
Size: 200 mm
03-266
Size: 210 mm

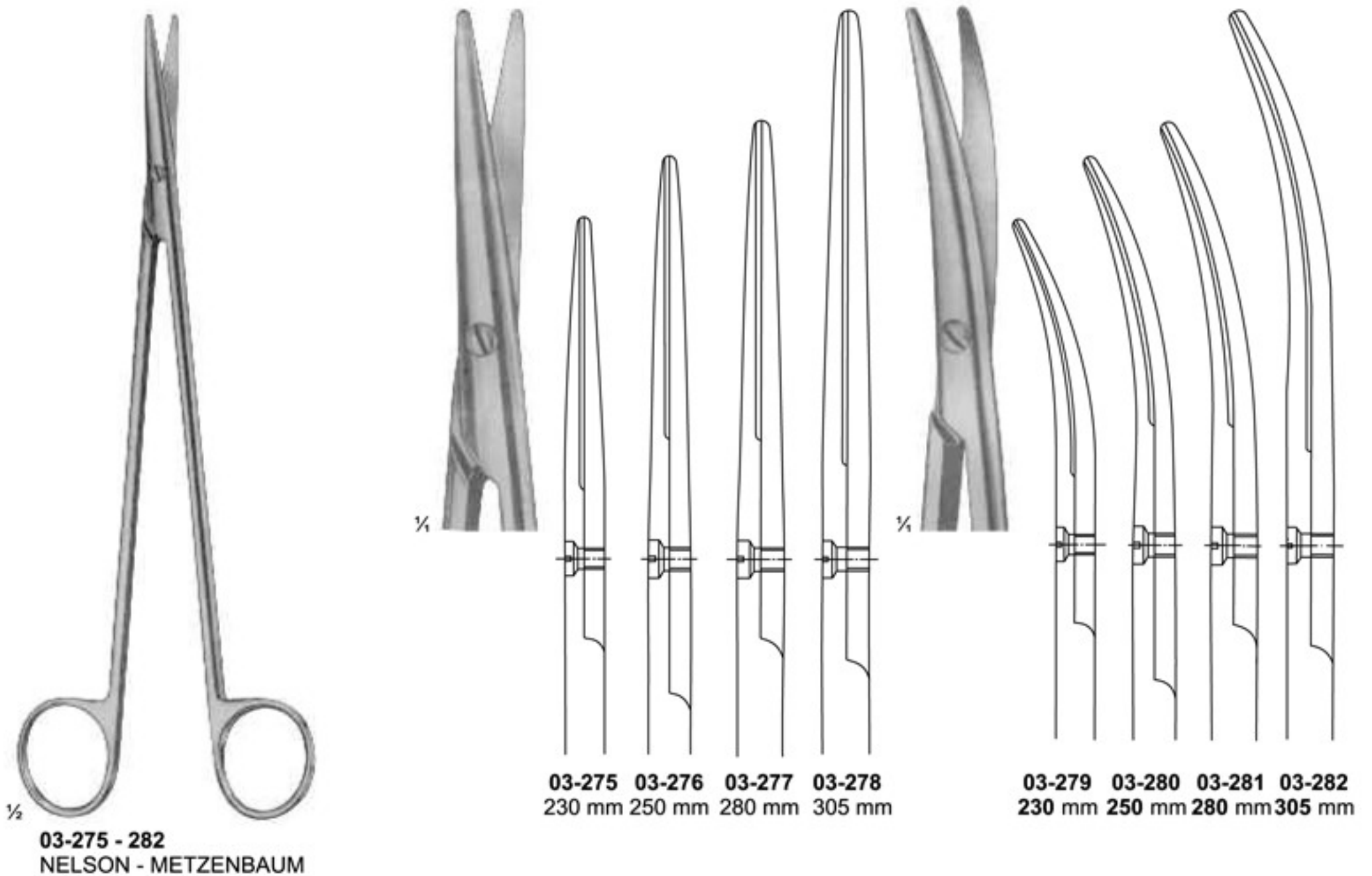
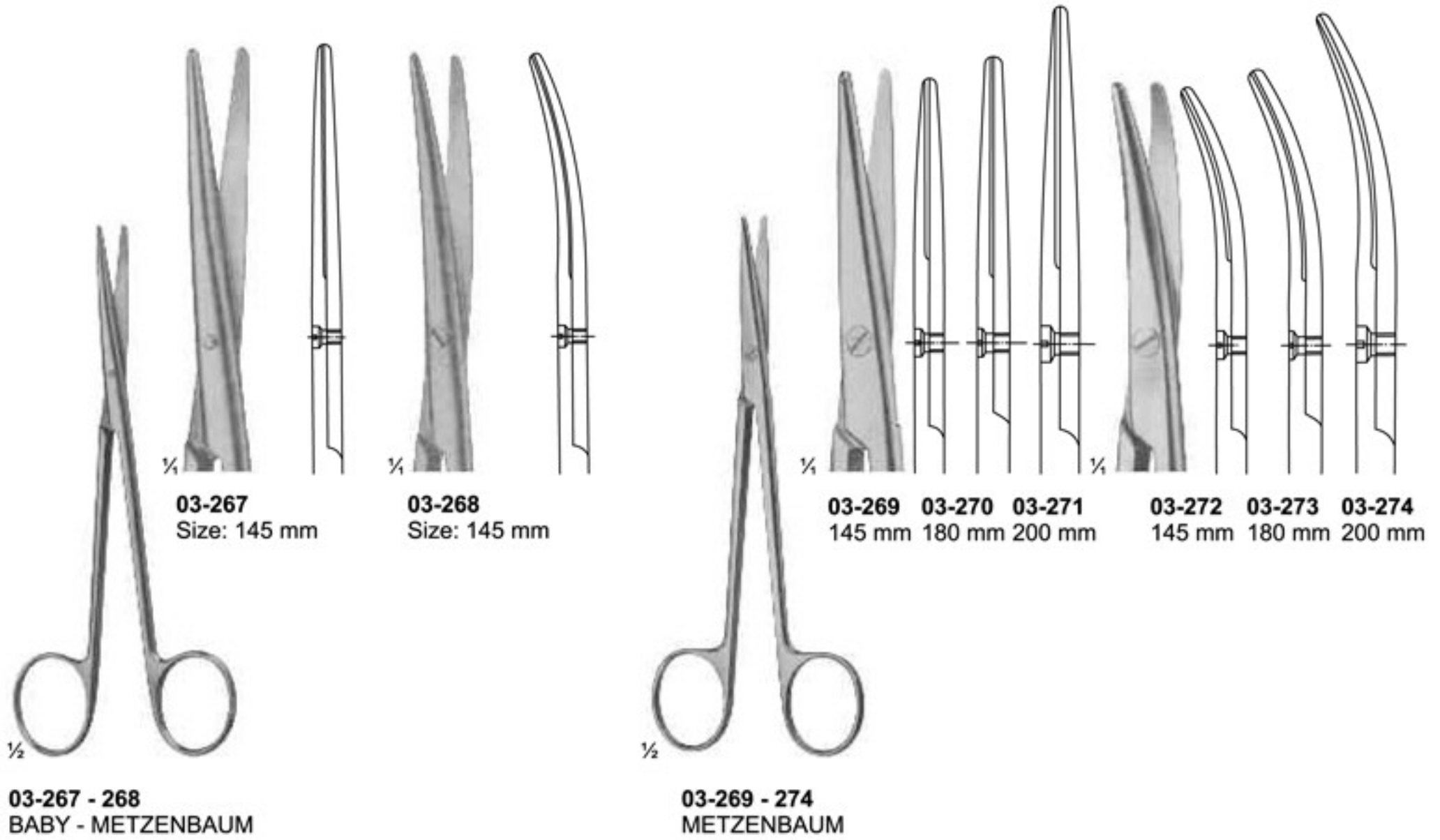

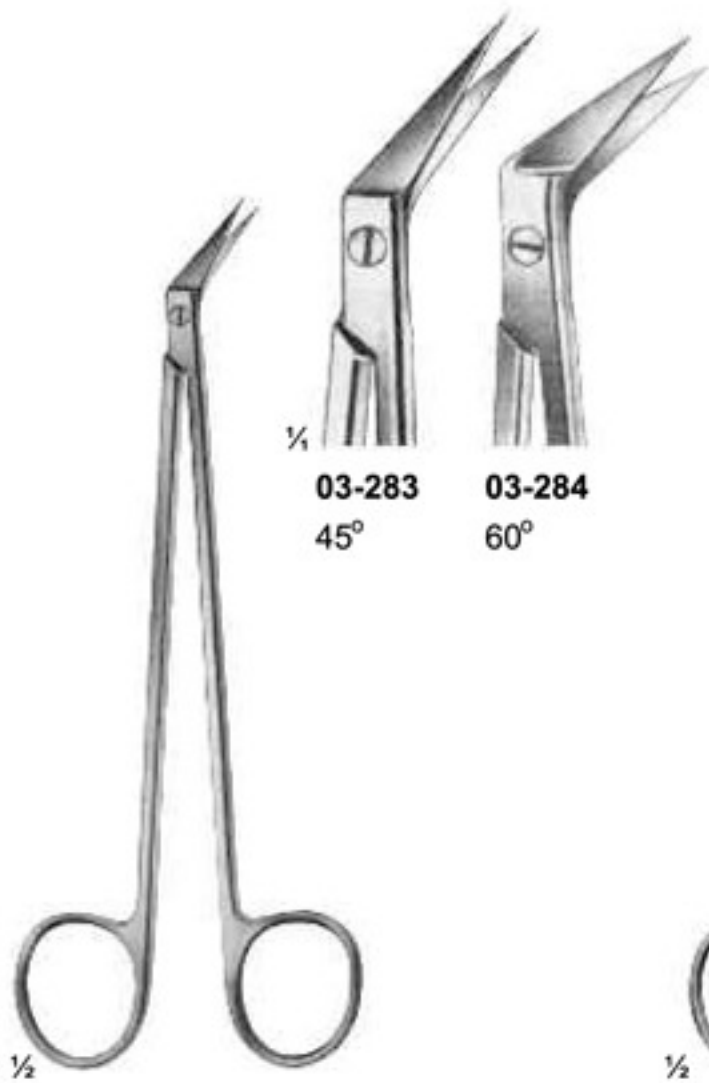

03-283
45°

03-284
60°

03-283 - 284
DE BAKEY
Size: 155 mm

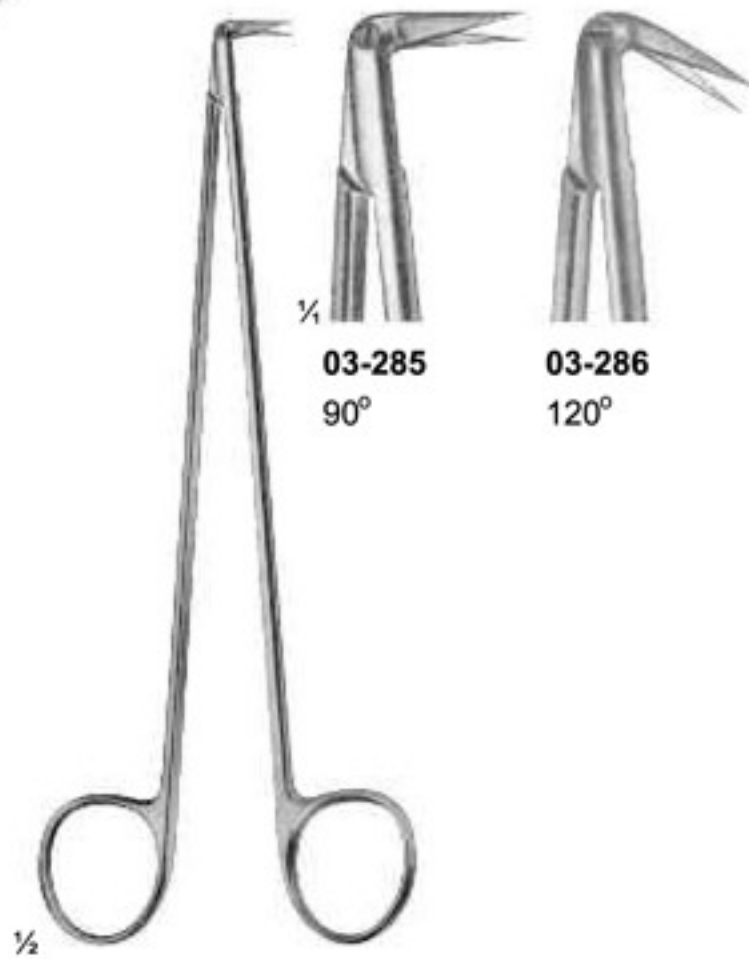

03-285
90°

03-286
120°

03-285 - 286
DIETRICH
Size: 170 mm

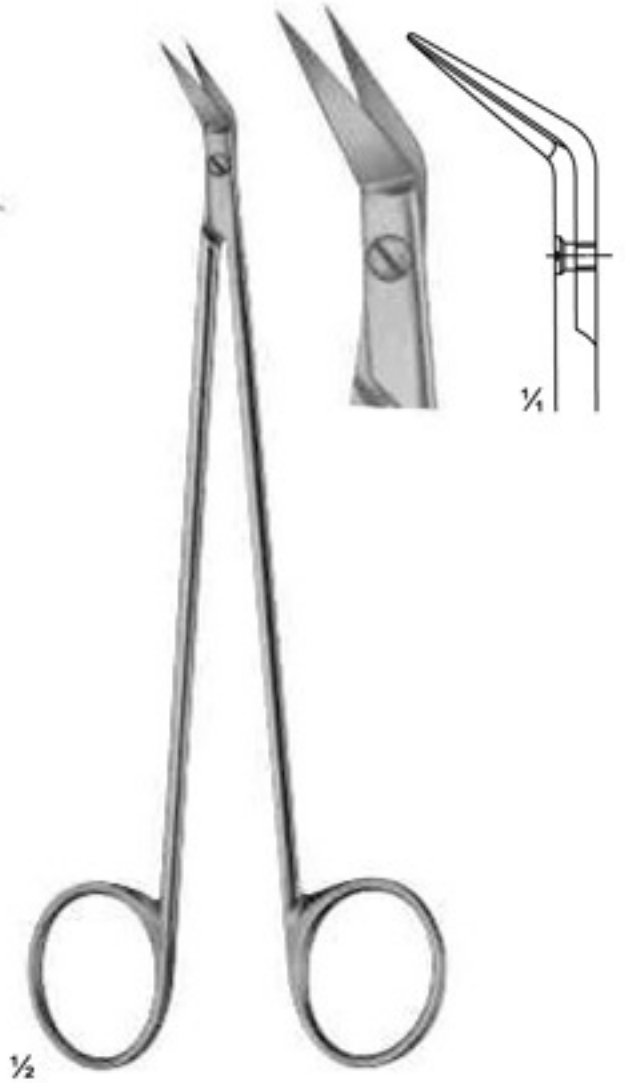

03-287
POTTS-SMITH
Size: 180 mm



03-288
60°

03-288
POTTS-SMITH
Size: 180 mm

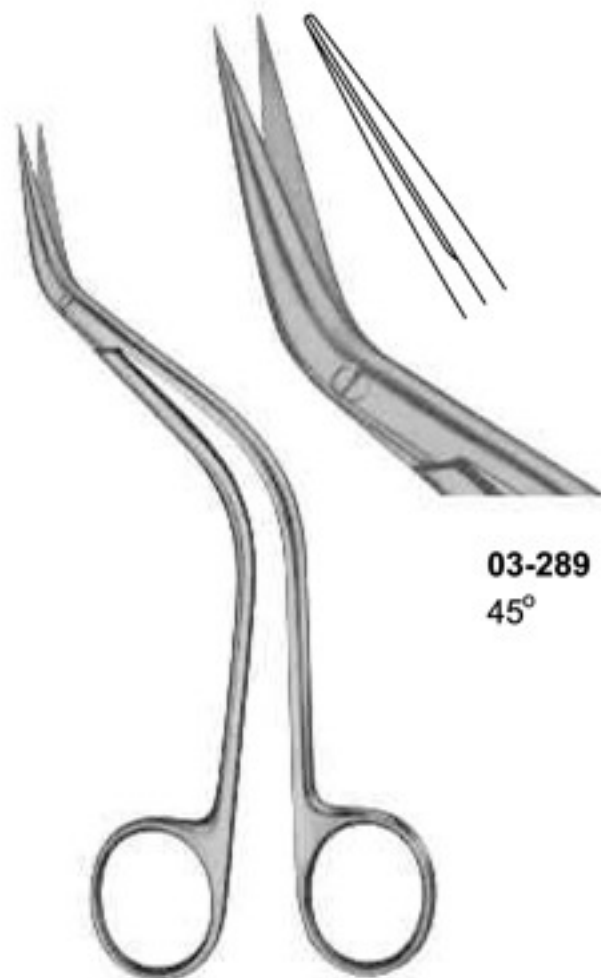

03-289
45°

03-289
DEBAKEY
Size: 155 mm

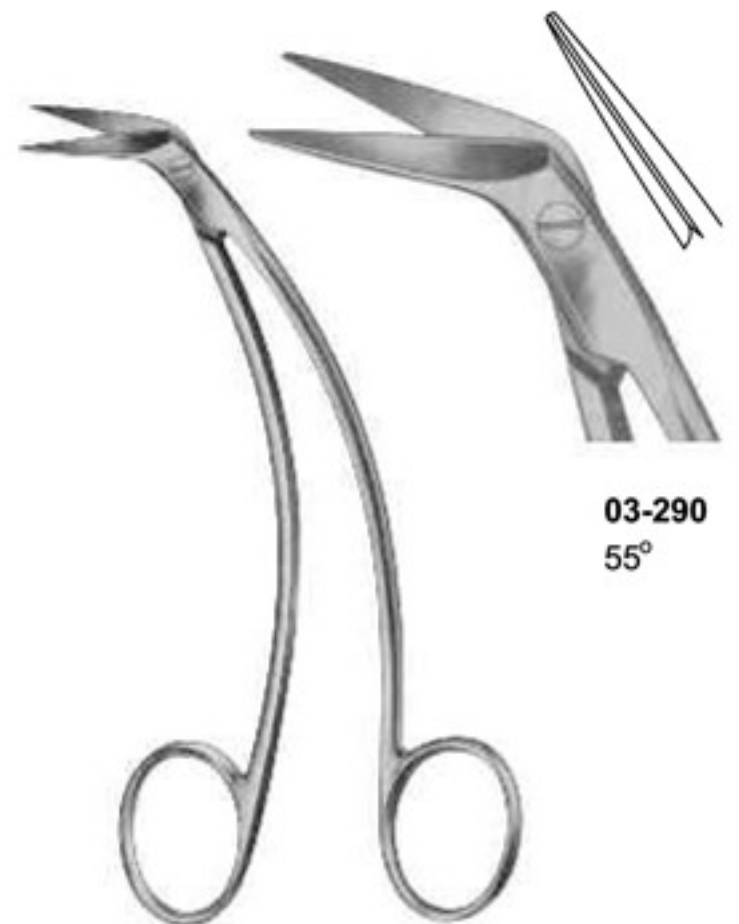

03-290
55°

03-290
FAVOLORO
Size: 140 mm



03-291
OLIVECRONA
Dura Scissors



03-292
STRULLY
Pointed
Size: 220 mm

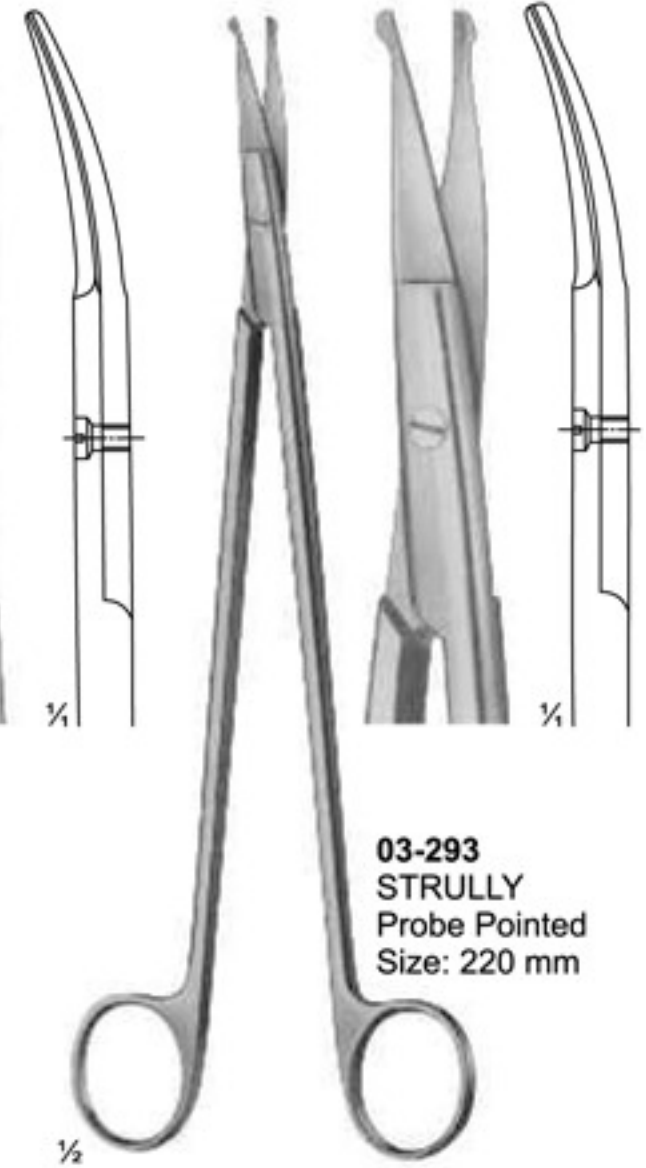

03-293
STRULLY
Probe Pointed
Size: 220 mm

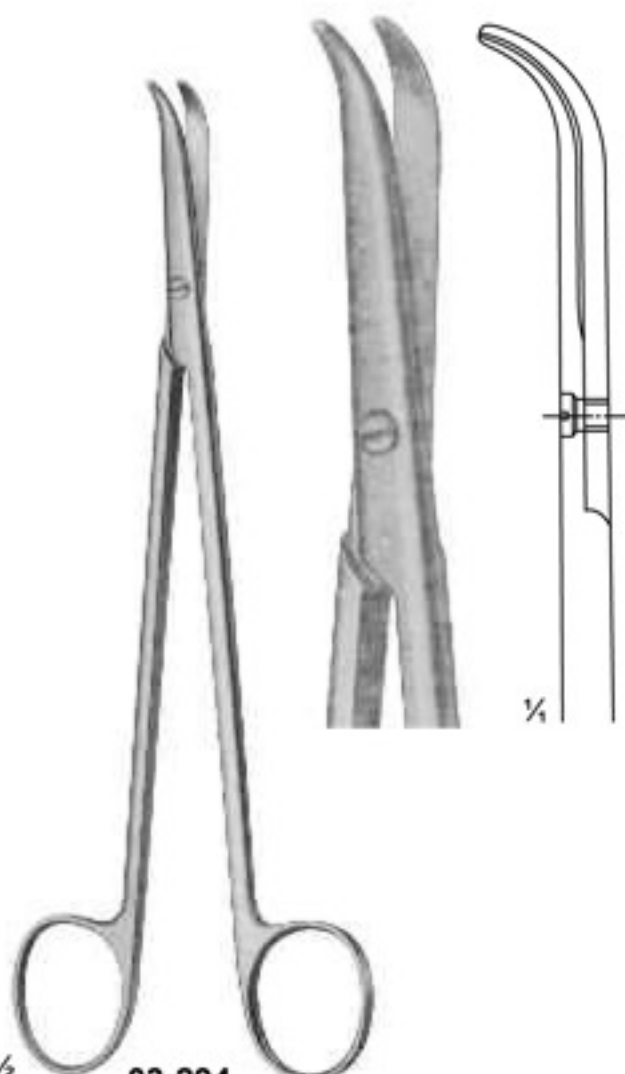

03-294
THOREK
Size: 180 mm

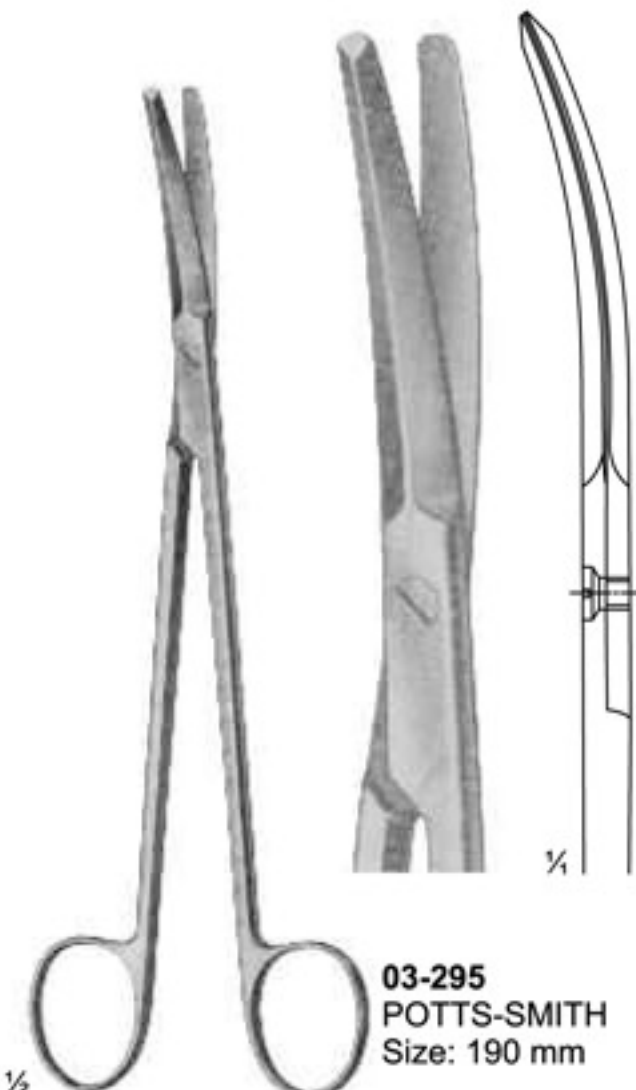

03-295
POTTS-SMITH
Size: 190 mm

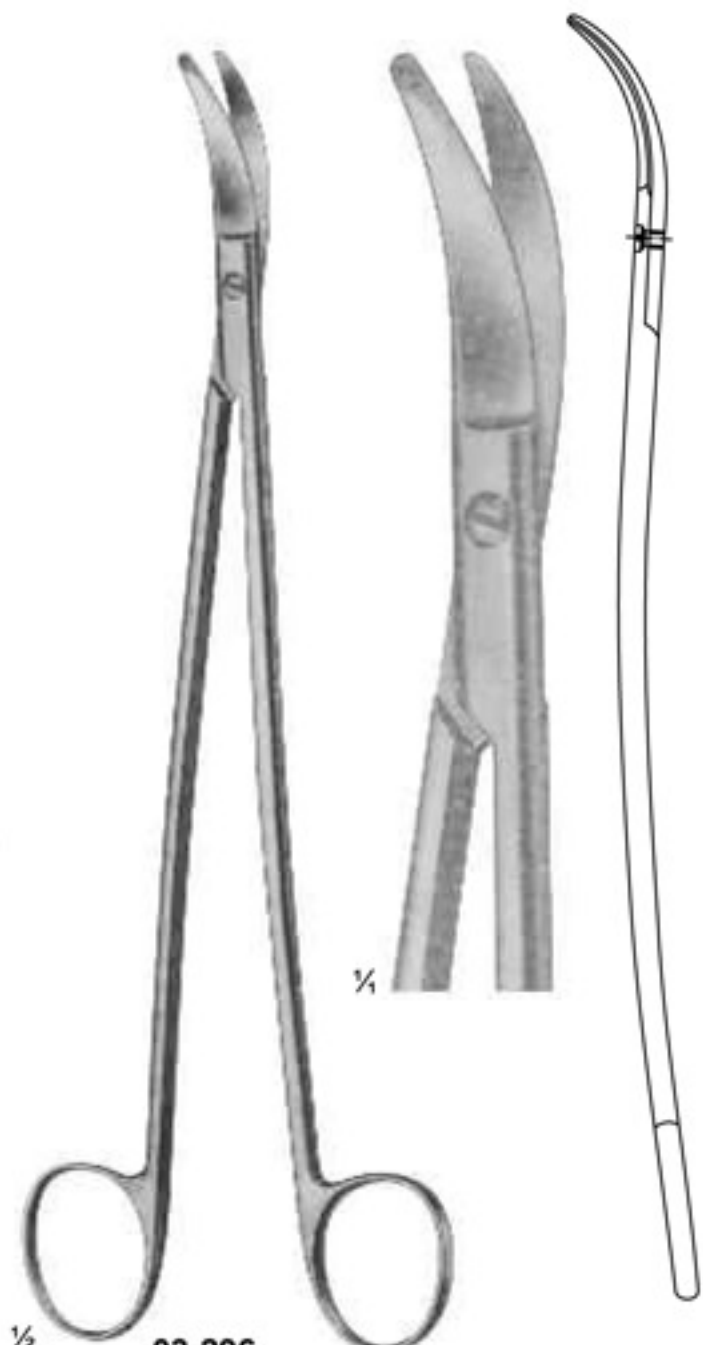

03-296
SATINSKY
Size: 245 mm



03-297
1 Finely Toothed Blade
Size: 130 mm

03-298
LOCKLIN
Curved Sideways,
1 Toothed Blade
Size: 155 mm

03-299
FOMON
Blades Serrated
Size: 145 mm

03-300
COTTLE
Size: 165 mm

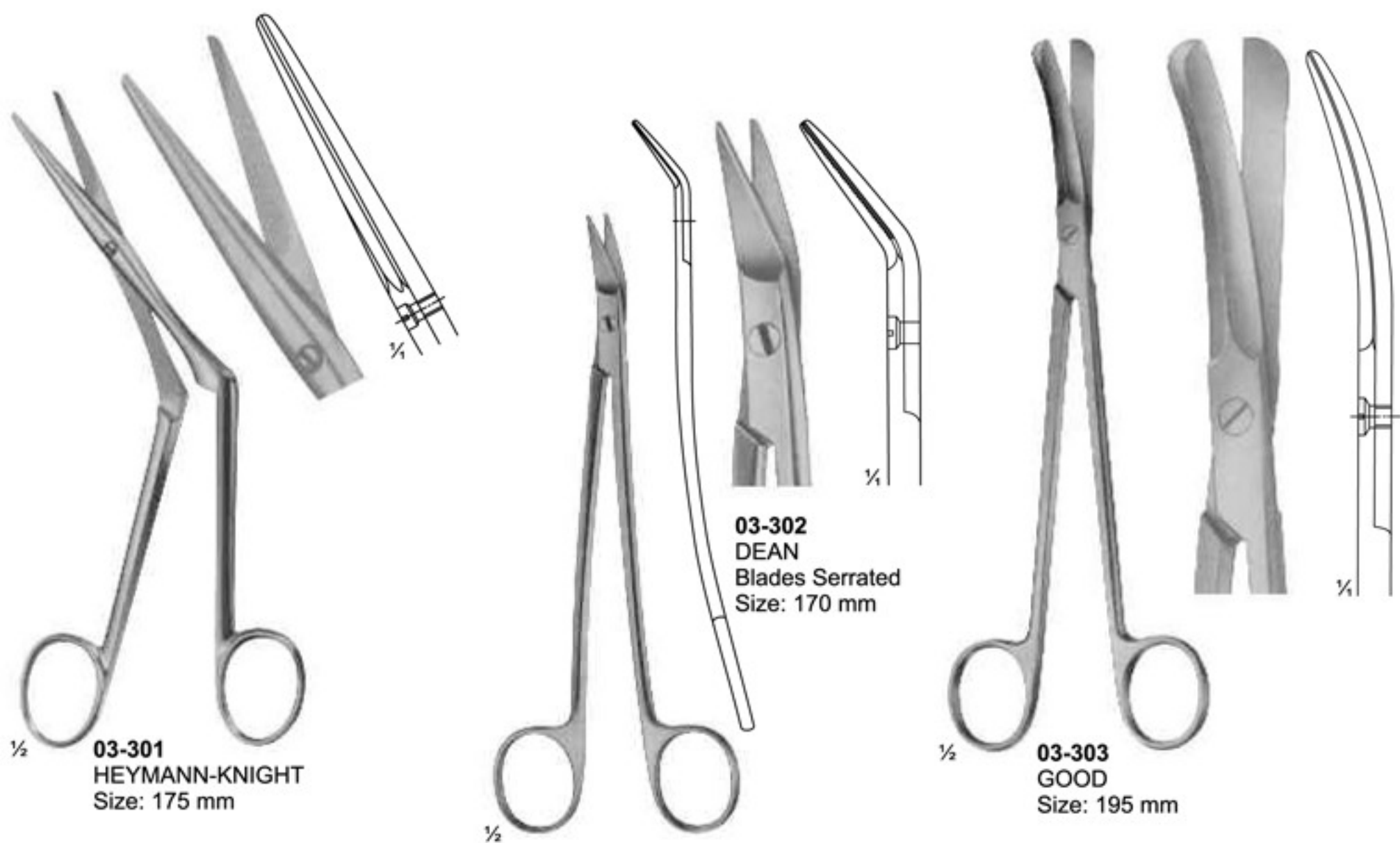

03-301
HEYMANN-KNIGHT
Size: 175 mm

03-302
DEAN
Blades Serrated
Size: 170 mm

03-303
GOOD
Size: 195 mm

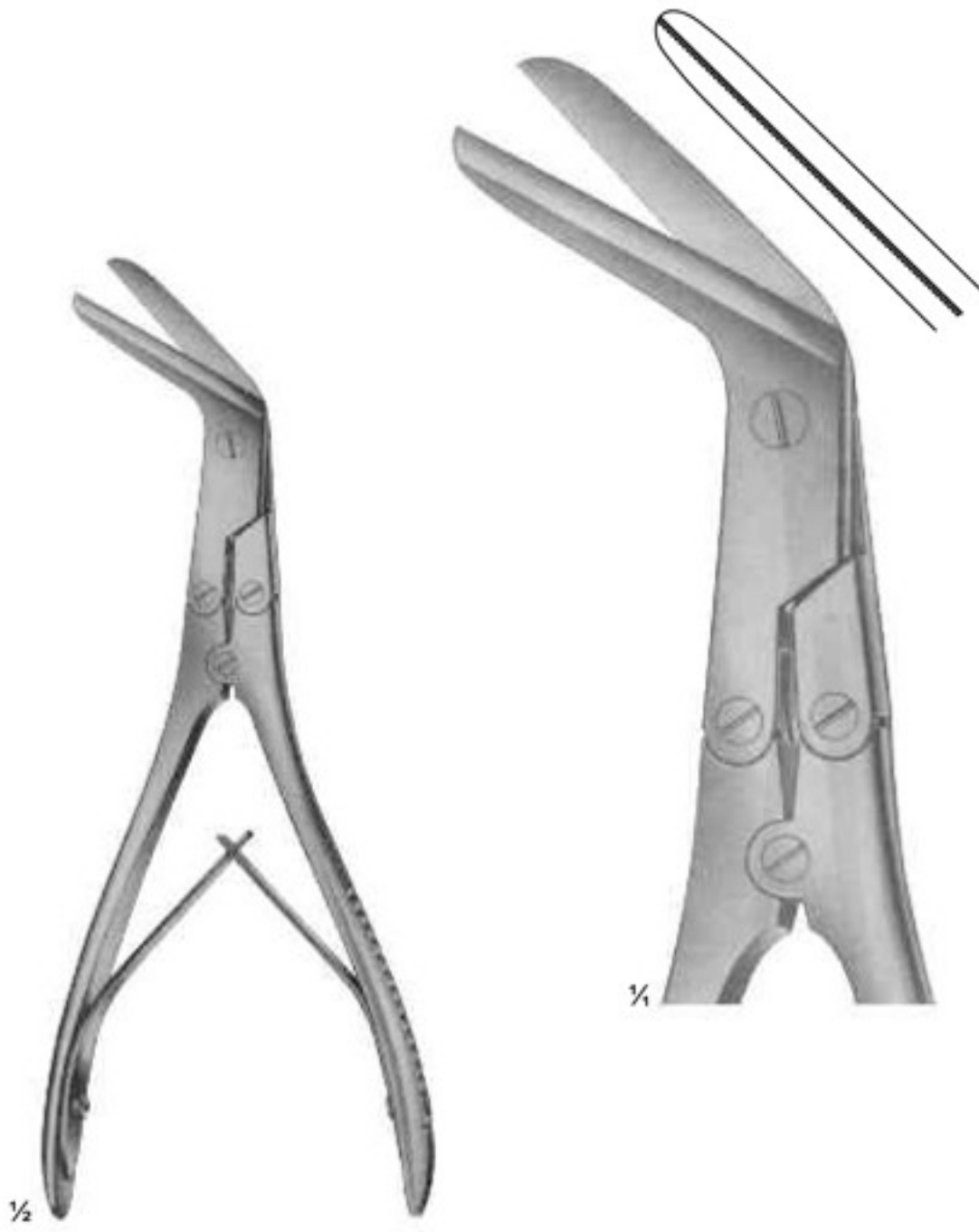

03-304
KILLIAN
Size: 200 mm

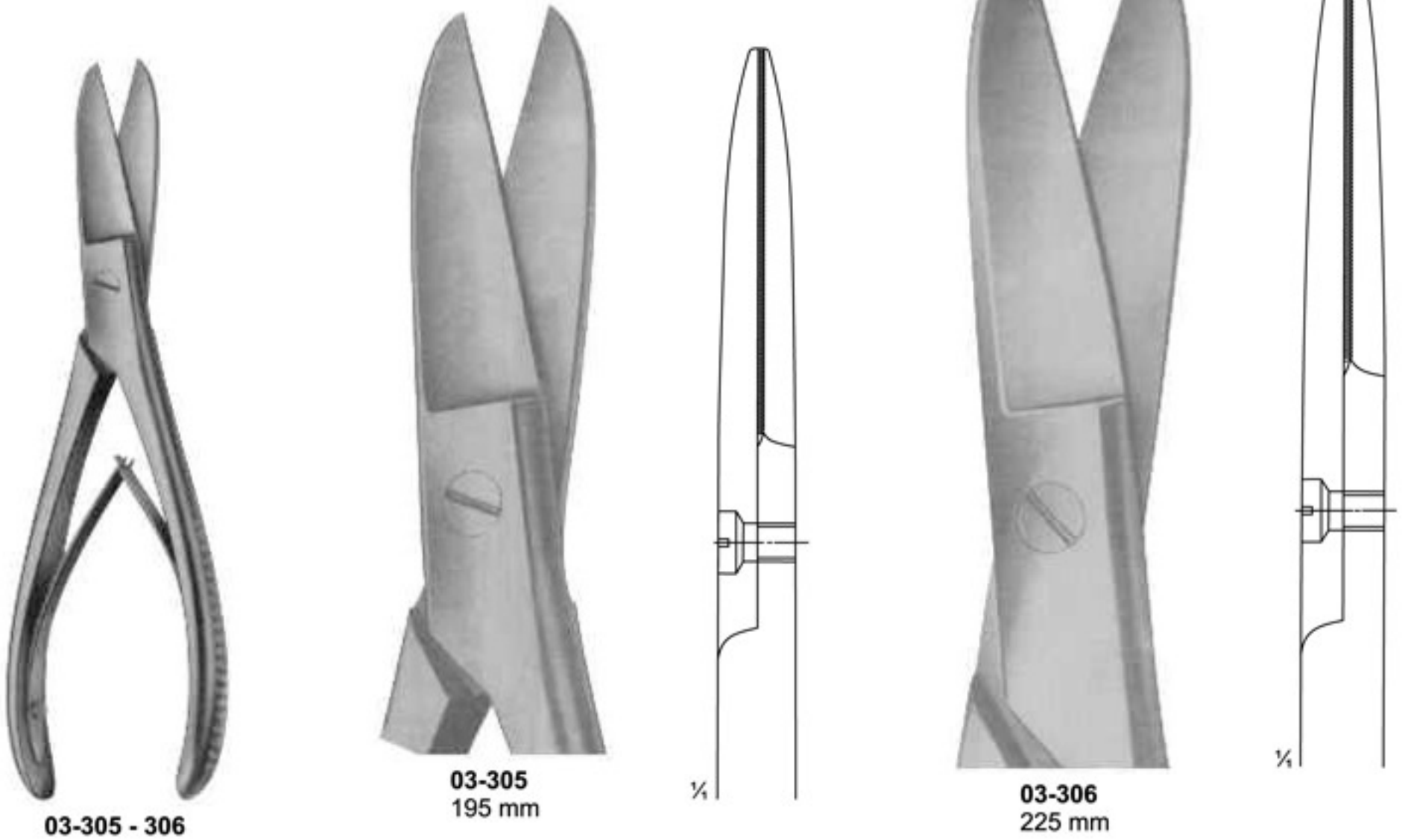

03-305 - 306

03-305
195 mm

03-306
225 mm

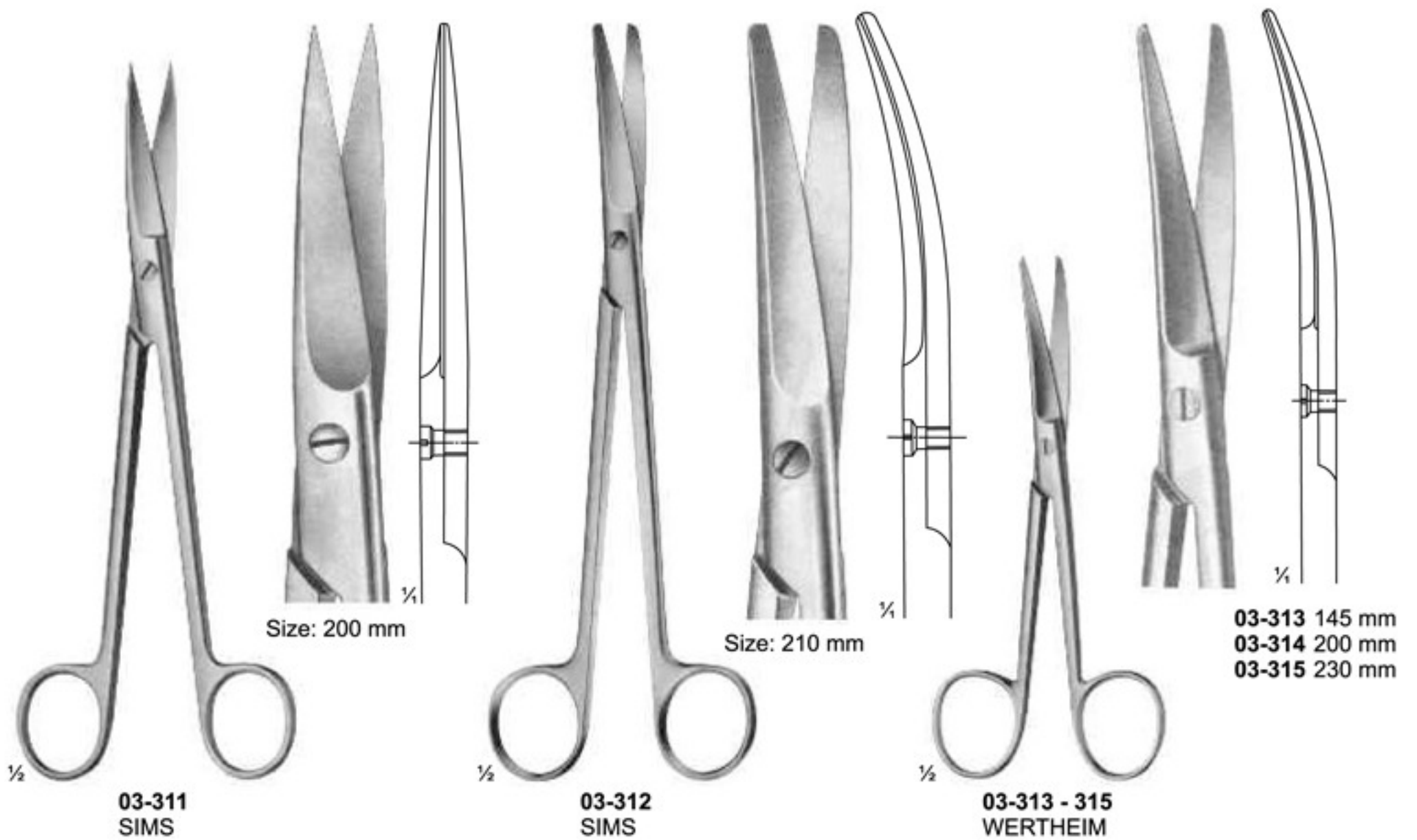
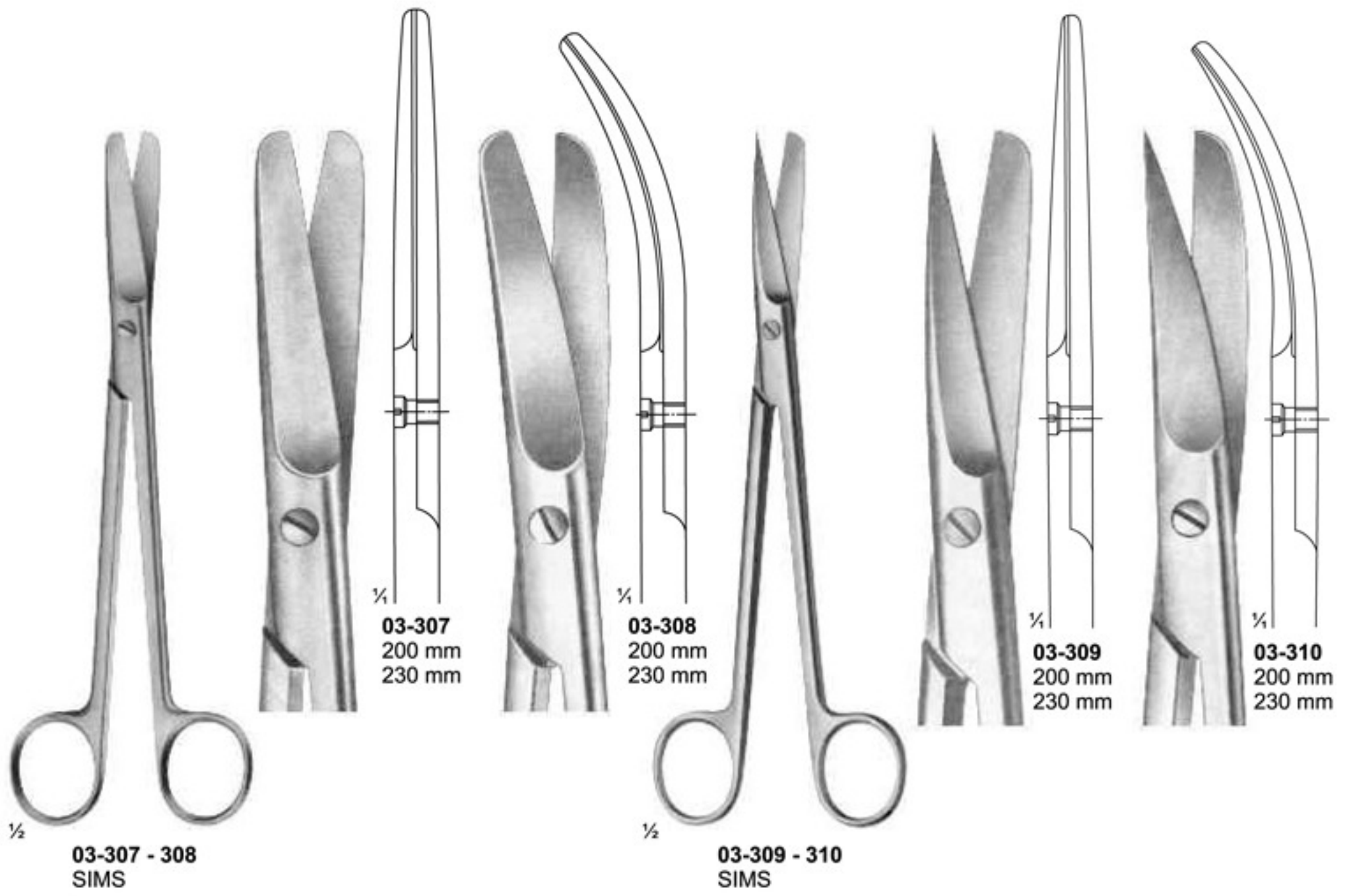



03-316
SIEBOLD
 Uterine Scissors
 Size: 245 mm

03-317
BOZEMANN
 Uterine Scissors
 Size: 220 mm

03-318
SIMS-SIEBOLD
 Uterine Scissors
 Size: 250 mm

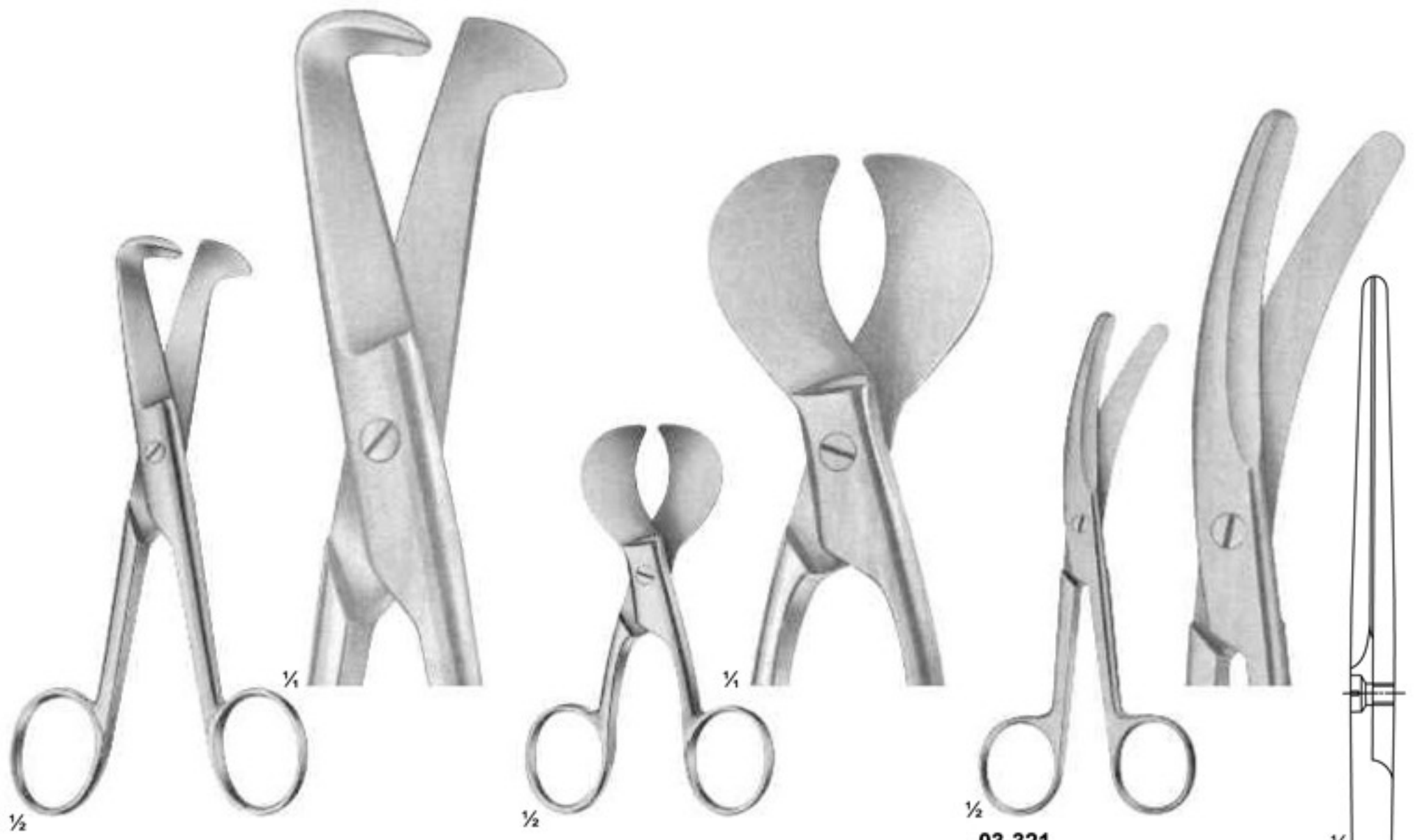

03-319
SCHUMACHER
 Umbilical Cord Scissors
 Size: 155 mm

03-320
 Umbilical Cord Scissors
 Size: 105 mm

03-321
 Umbilical Cord Scissors

135 mm

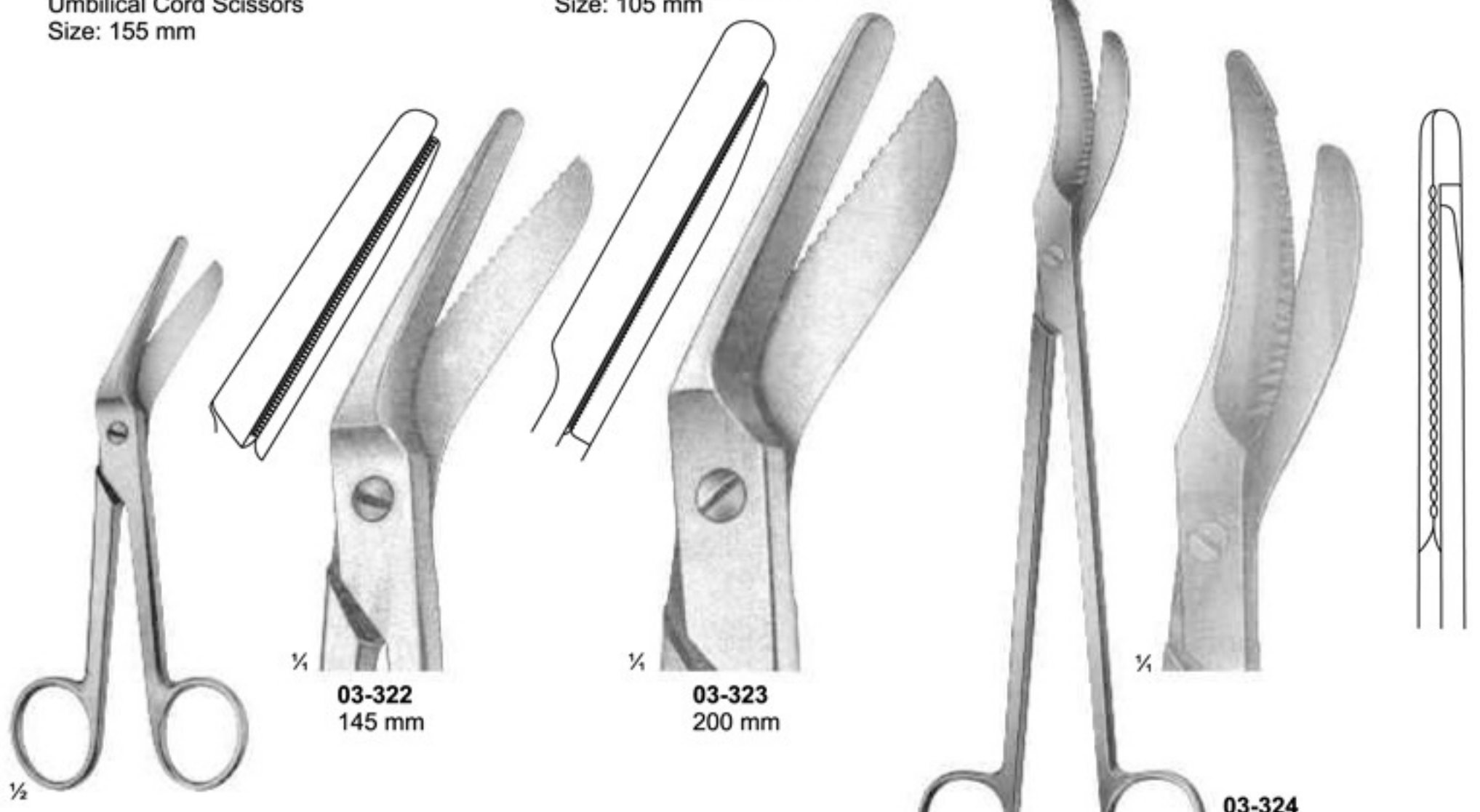

03-322 - 323
BRAUN-STADLER
 Episiotomy Scissors

03-322
 145 mm

03-323
 200 mm

03-324
DAMMSCHERE
 Episiotomy Scissors
 240 mm

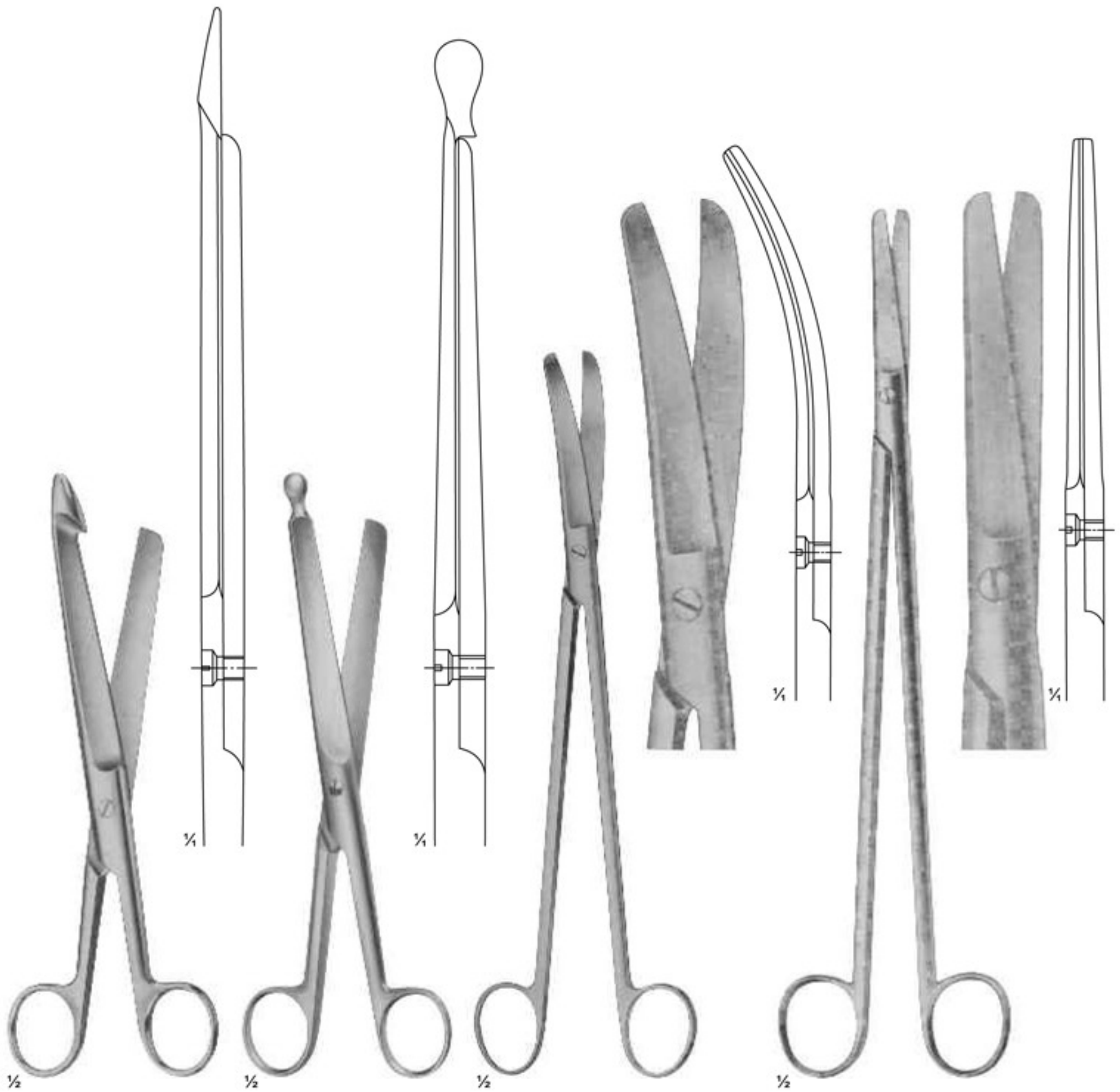

03-325
DAMMSCHERE
Bowel Scissors
Size: 210 mm

03-326
DAMMSCHERE
Bowel Scissors
Size: 210 mm

03-327
LLOYD-DAVIES
(GOLIGHER'S)
Rectal Scissors
Size: 255 mm

03-328
STELZNER
Rectal Scissors
Size: 310 mm

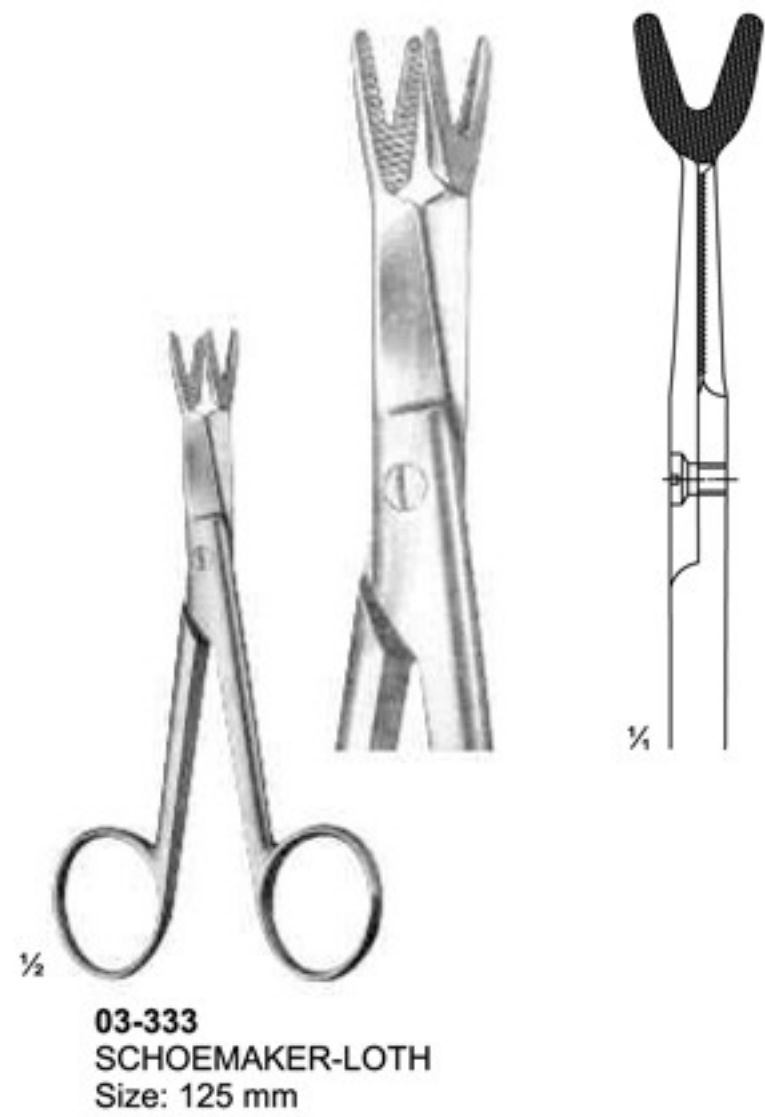
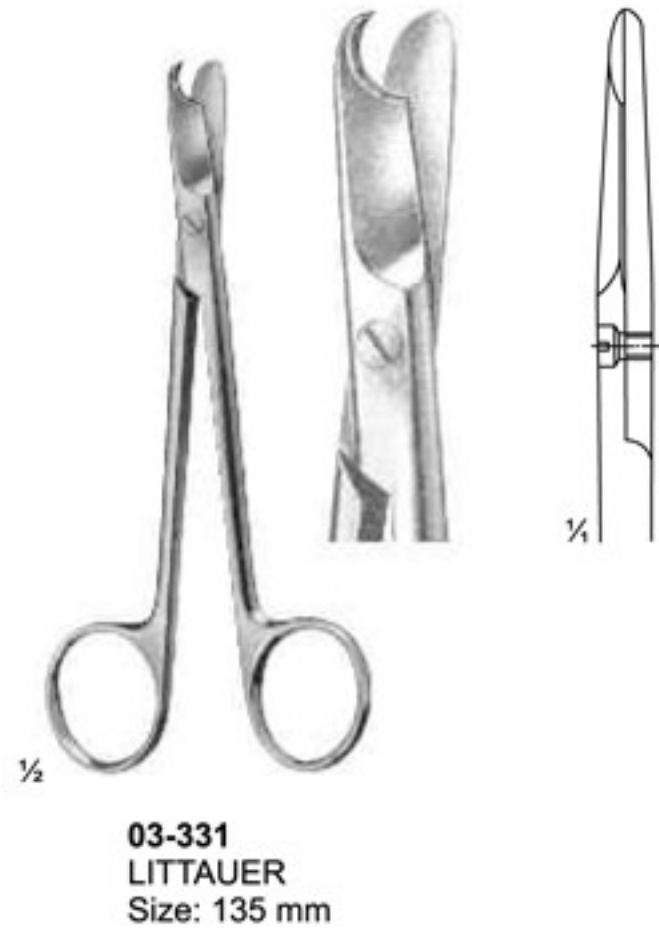
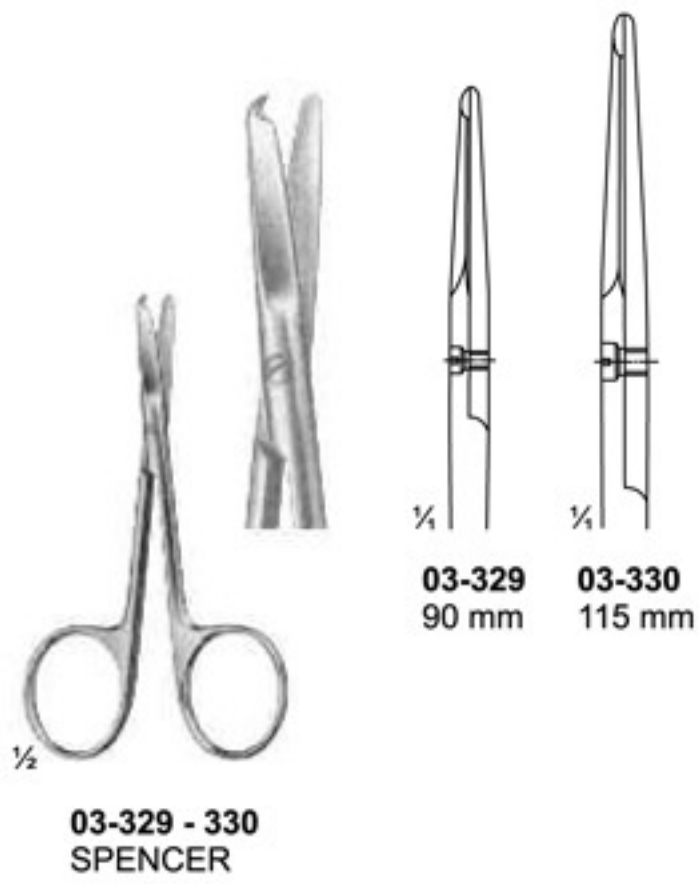

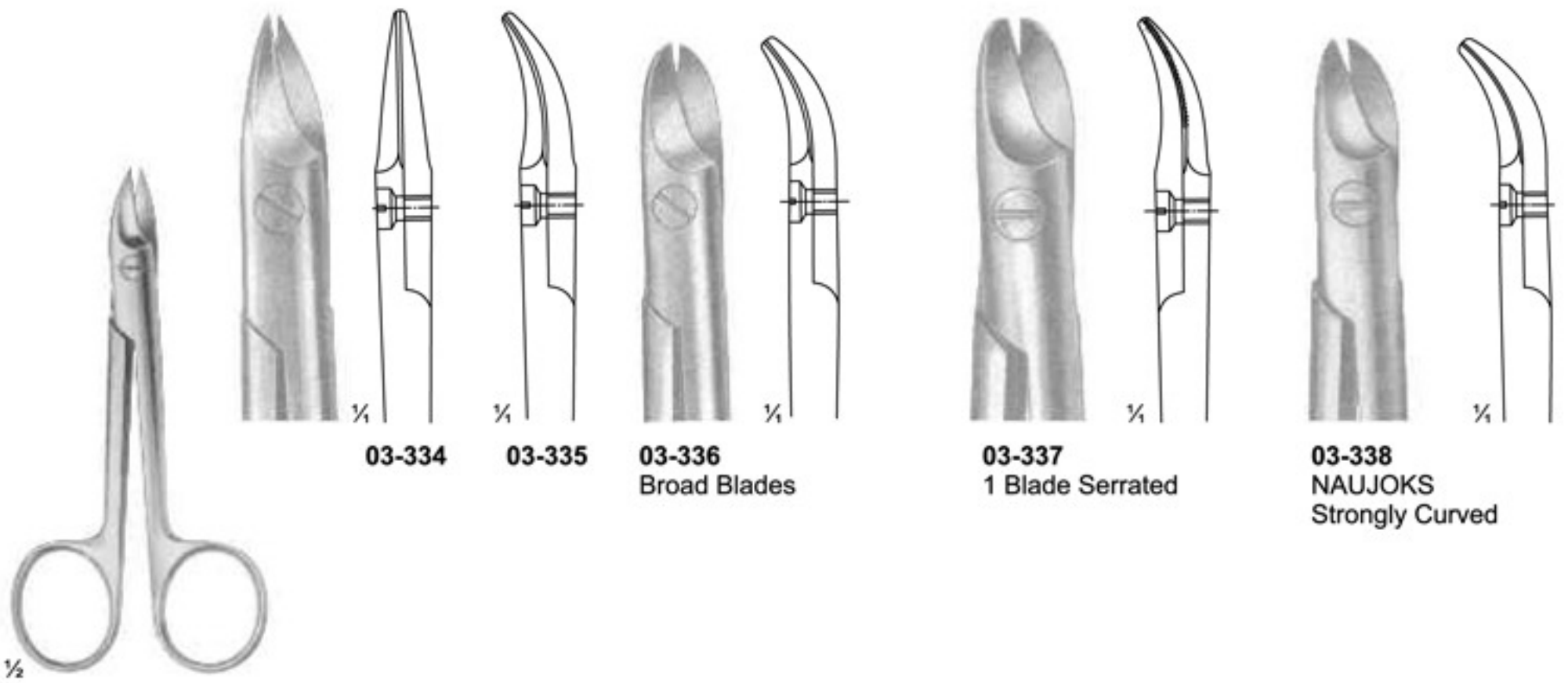

03-334

03-335

03-336
Broad Blades

03-337
1 Blade Serrated

03-338
NAUJOKS
Strongly Curved

03-334 - 338
BEEBE
Size: 110 mm

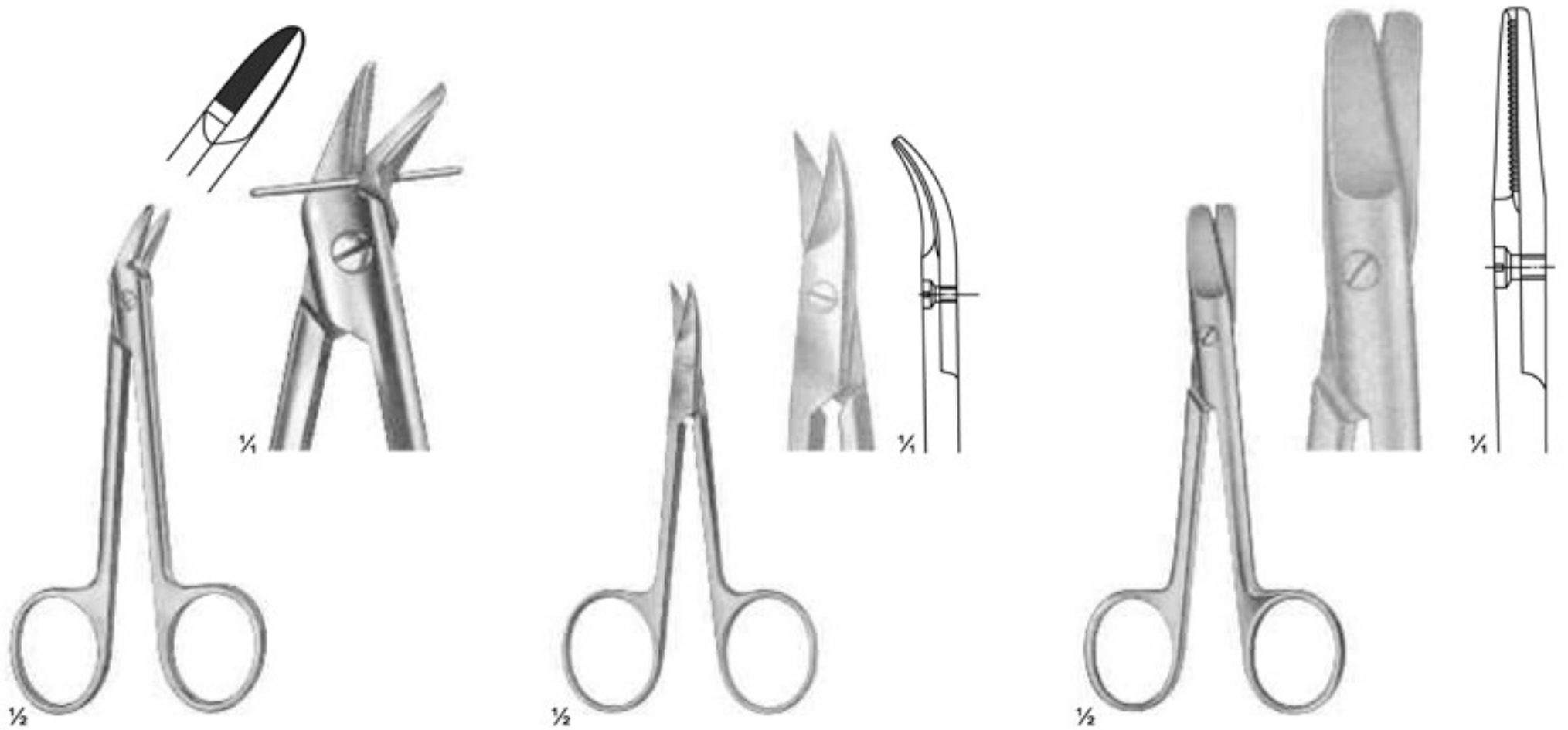

03-339
1 Blade Serrated
Size: 120 mm

03-340
STRACK
Size: 100 mm

03-341
HARVEY
Size: 125 mm

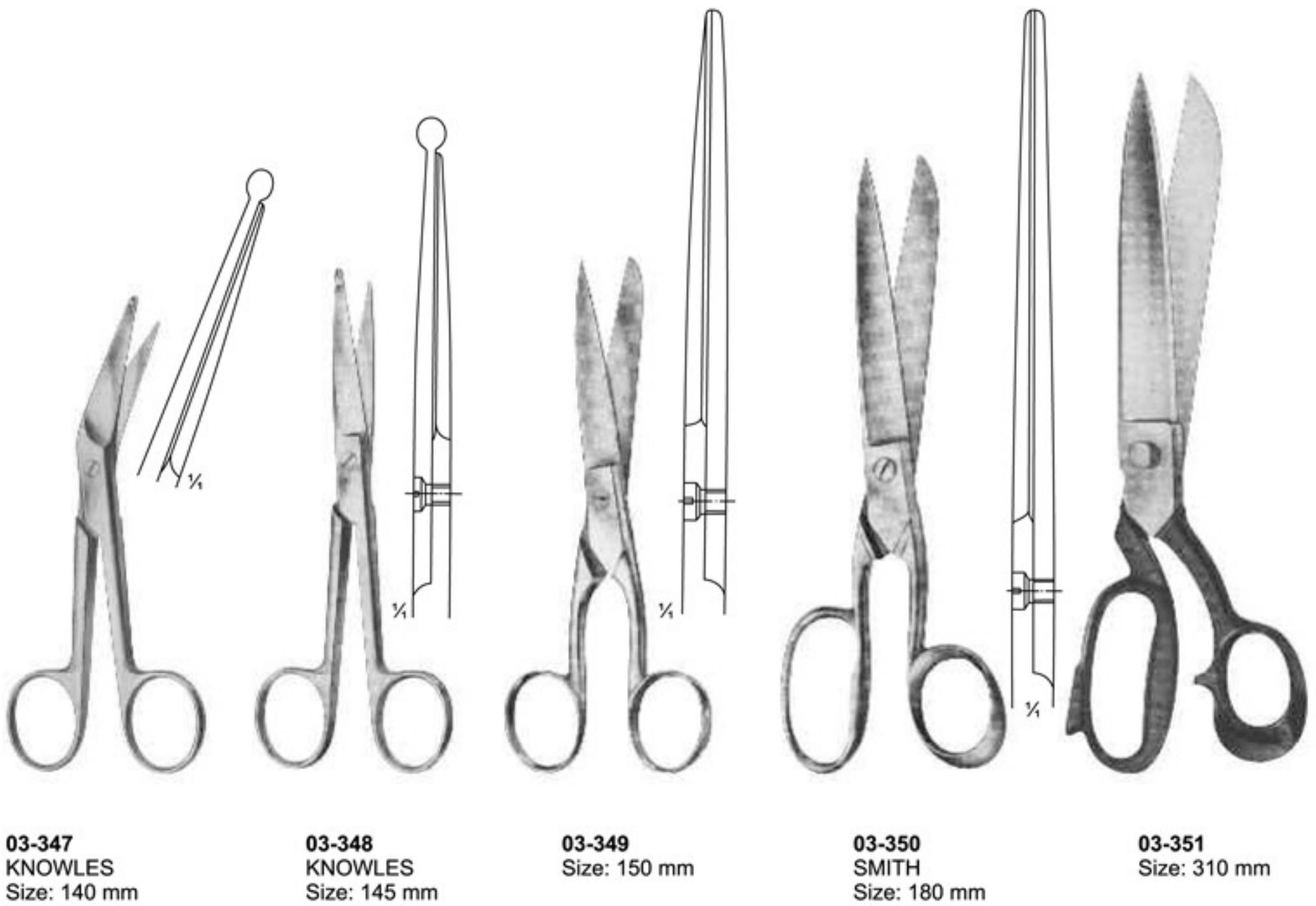
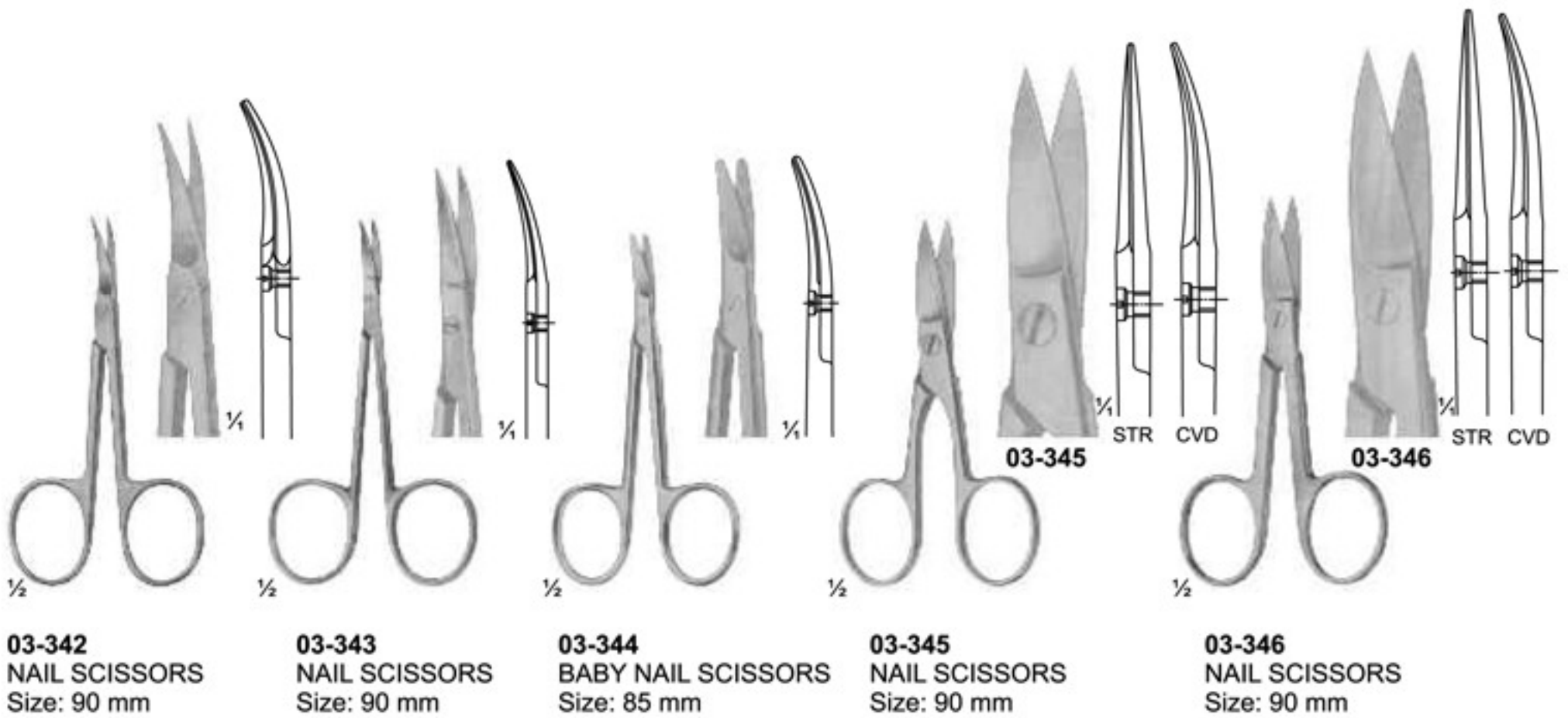



03-352
UNIVERSAL AND BANDAGE SCISSORS
180 mm

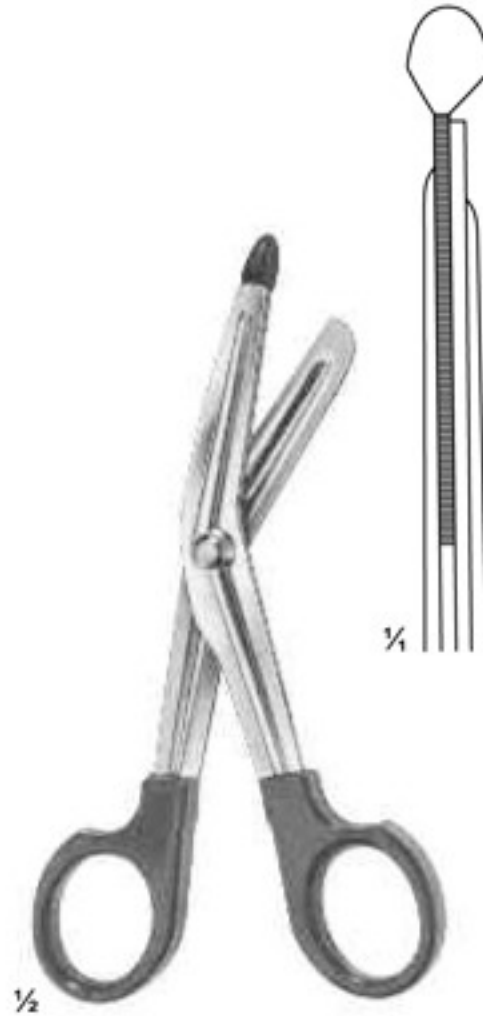
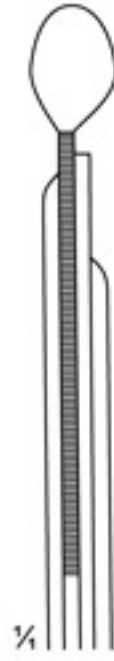

03-353
LISTER
Size: 145 mm

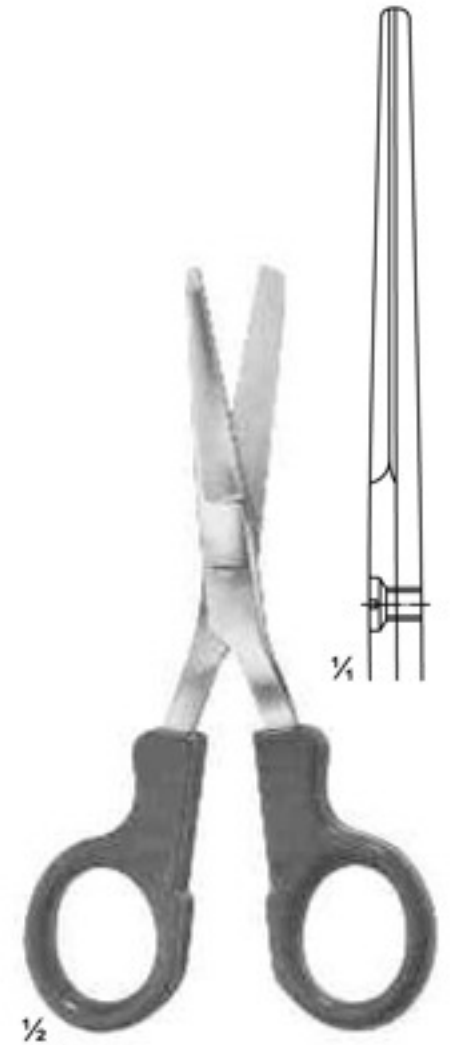
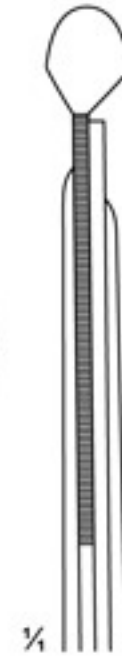

03-354
LISTER
Size: 145 mm

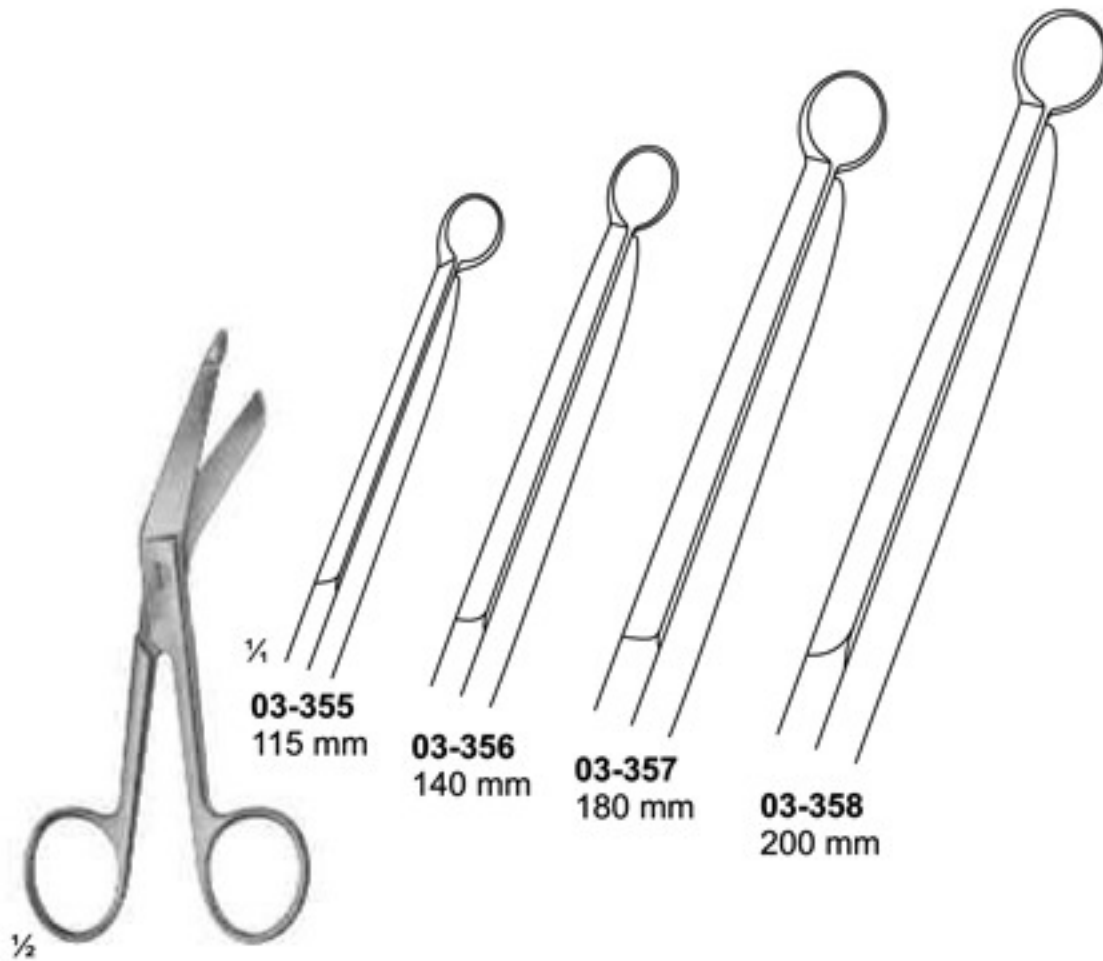
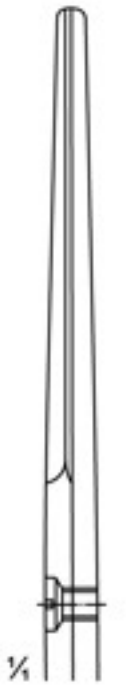

03-355 - 358
LISTER

03-355
115 mm

03-356
140 mm

03-357
180 mm

03-358
200 mm

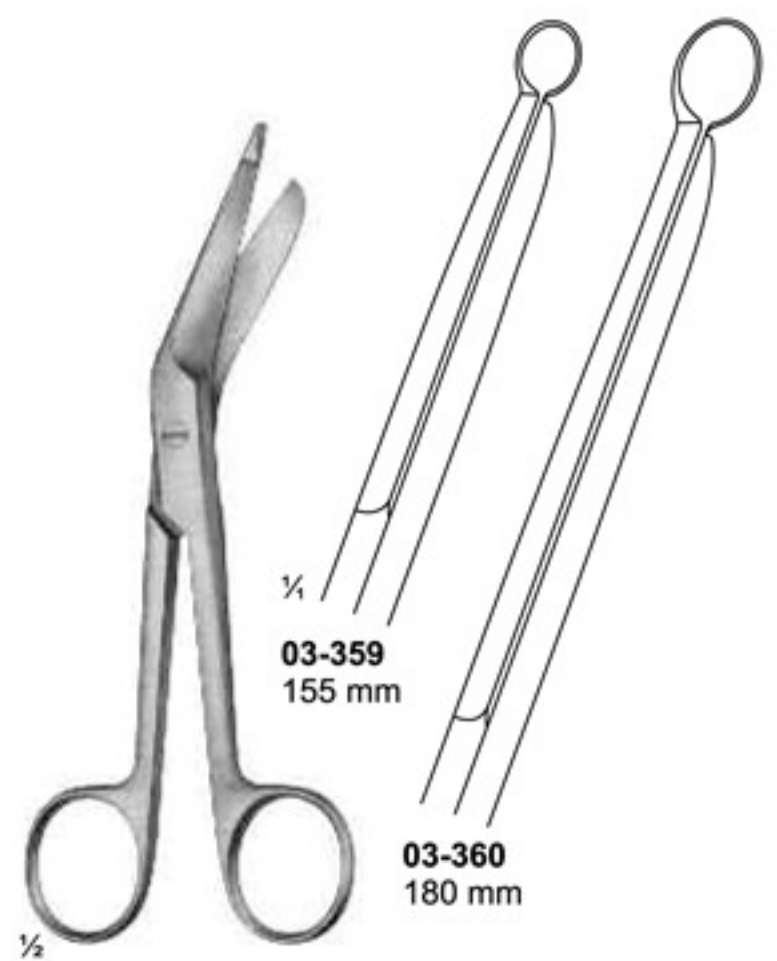

03-359 - 360
LISTER

03-359
155 mm

03-360
180 mm



03-361
CLOTH SCISSORS
205 mm

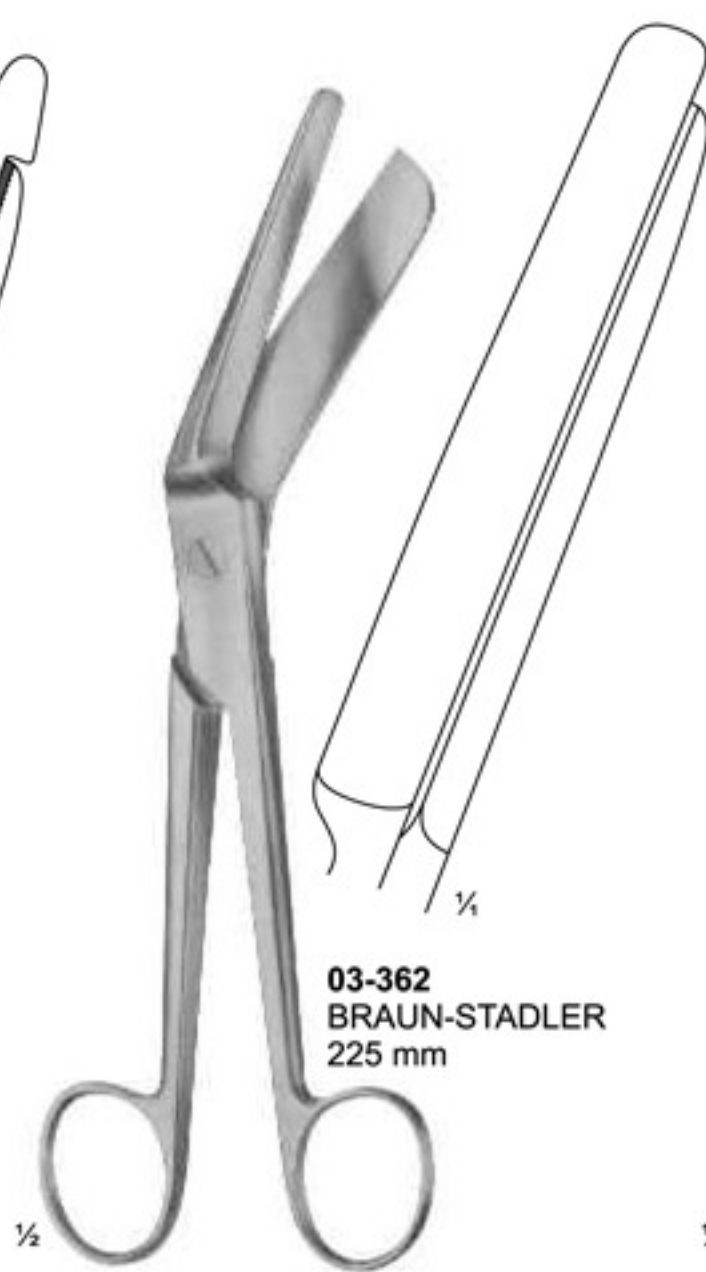

03-362
BRAUN-STADLER
225 mm

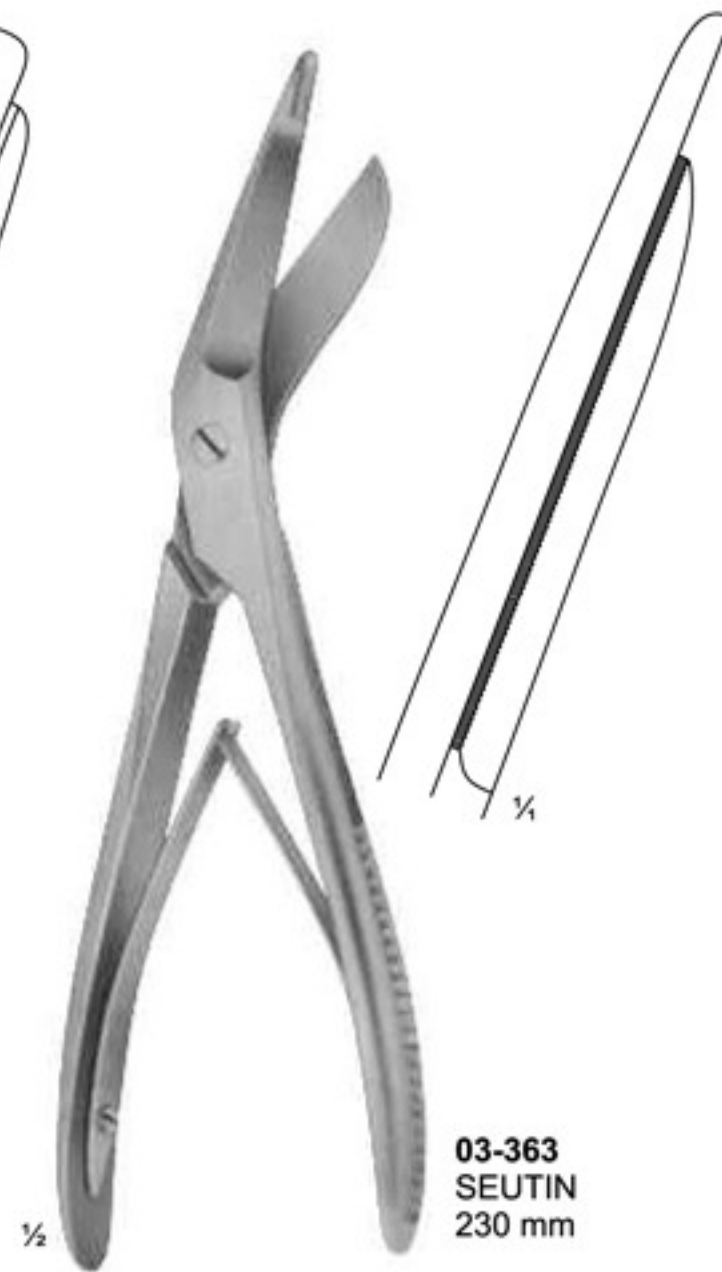

03-363
SEUTIN
230 mm



03-364 - 365
ESMARCH

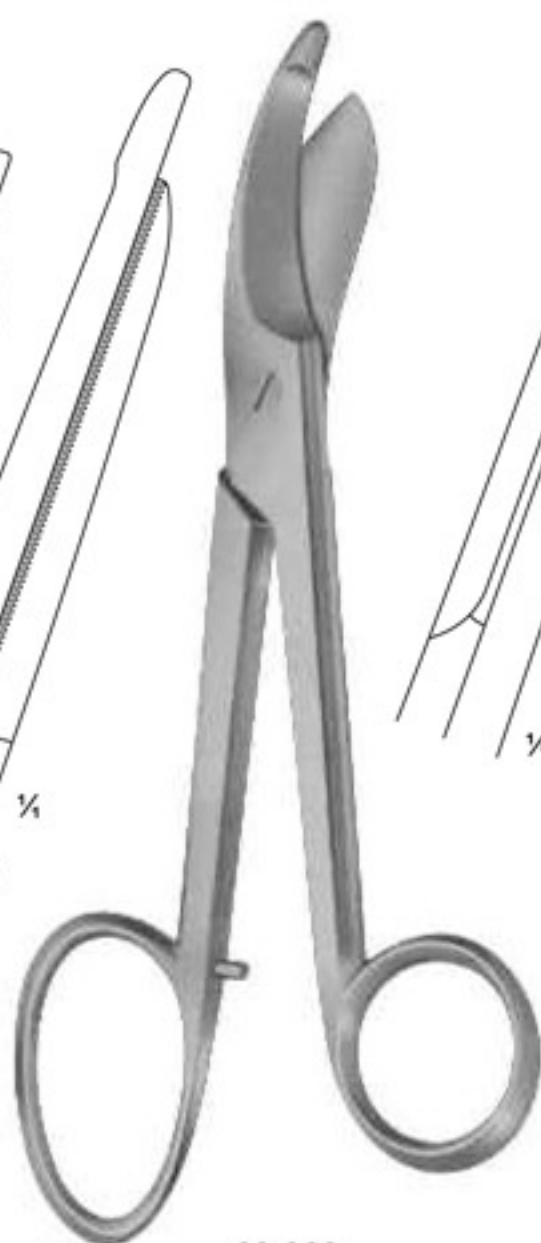

03-366
BRUNS
235 mm

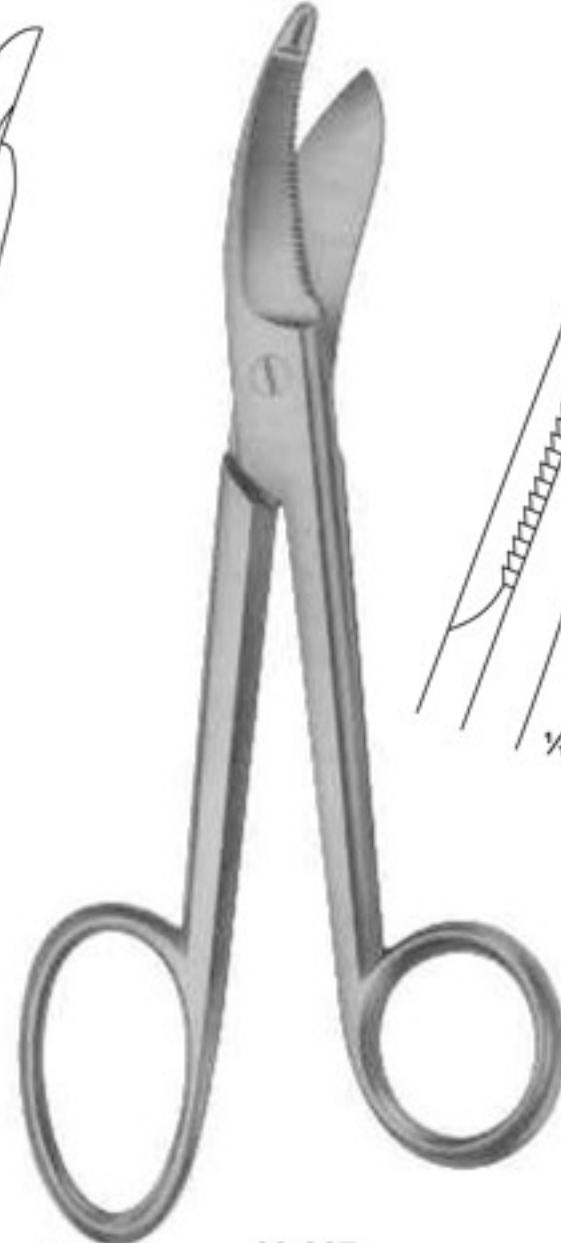
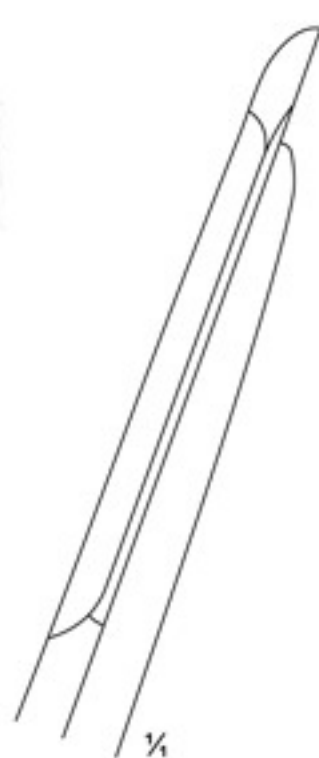

03-367
BRUNS
235 mm

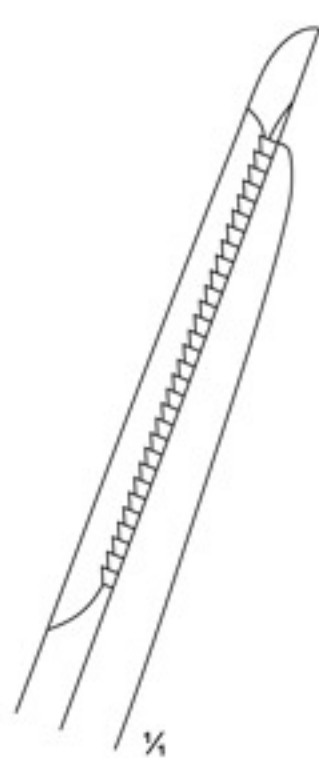

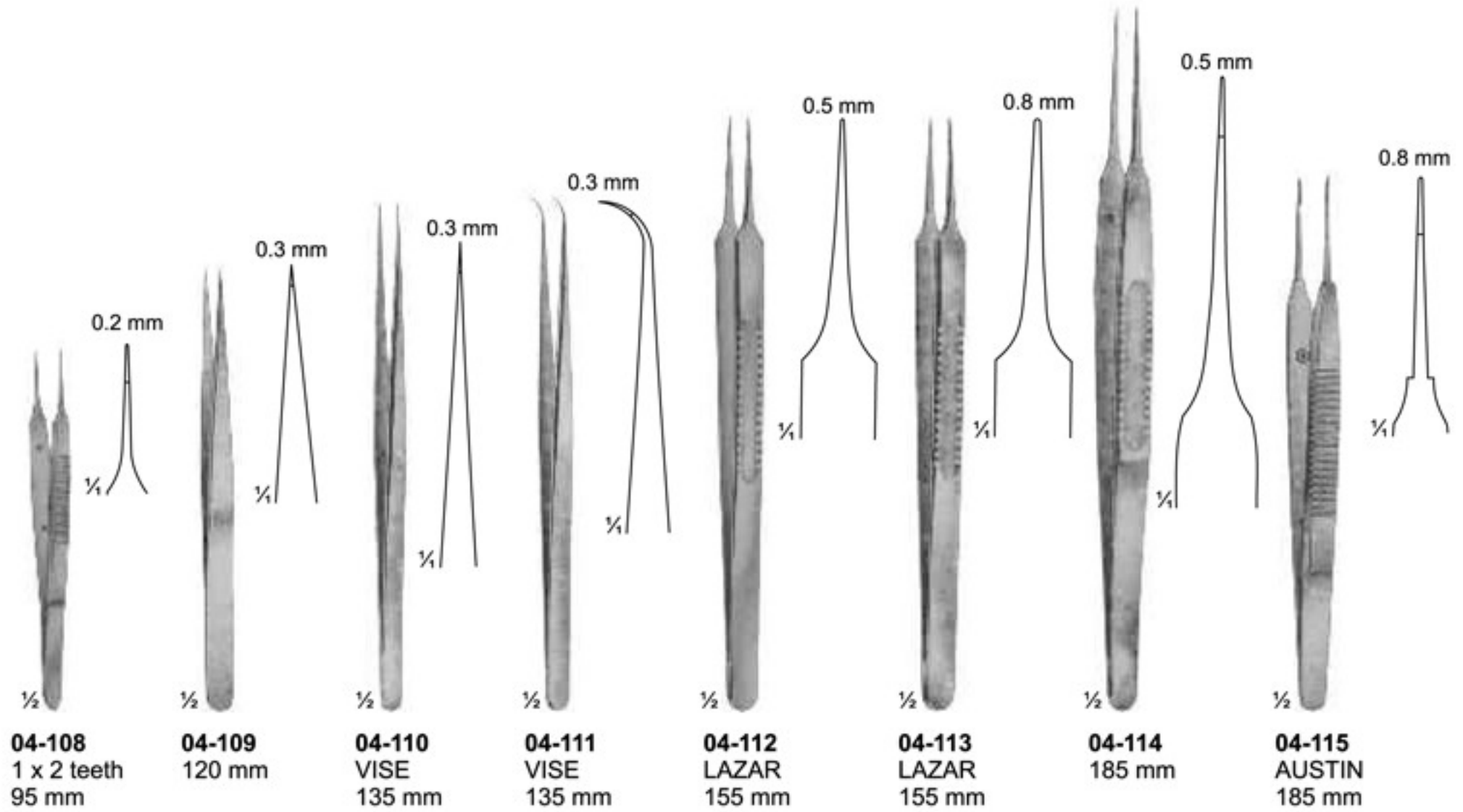
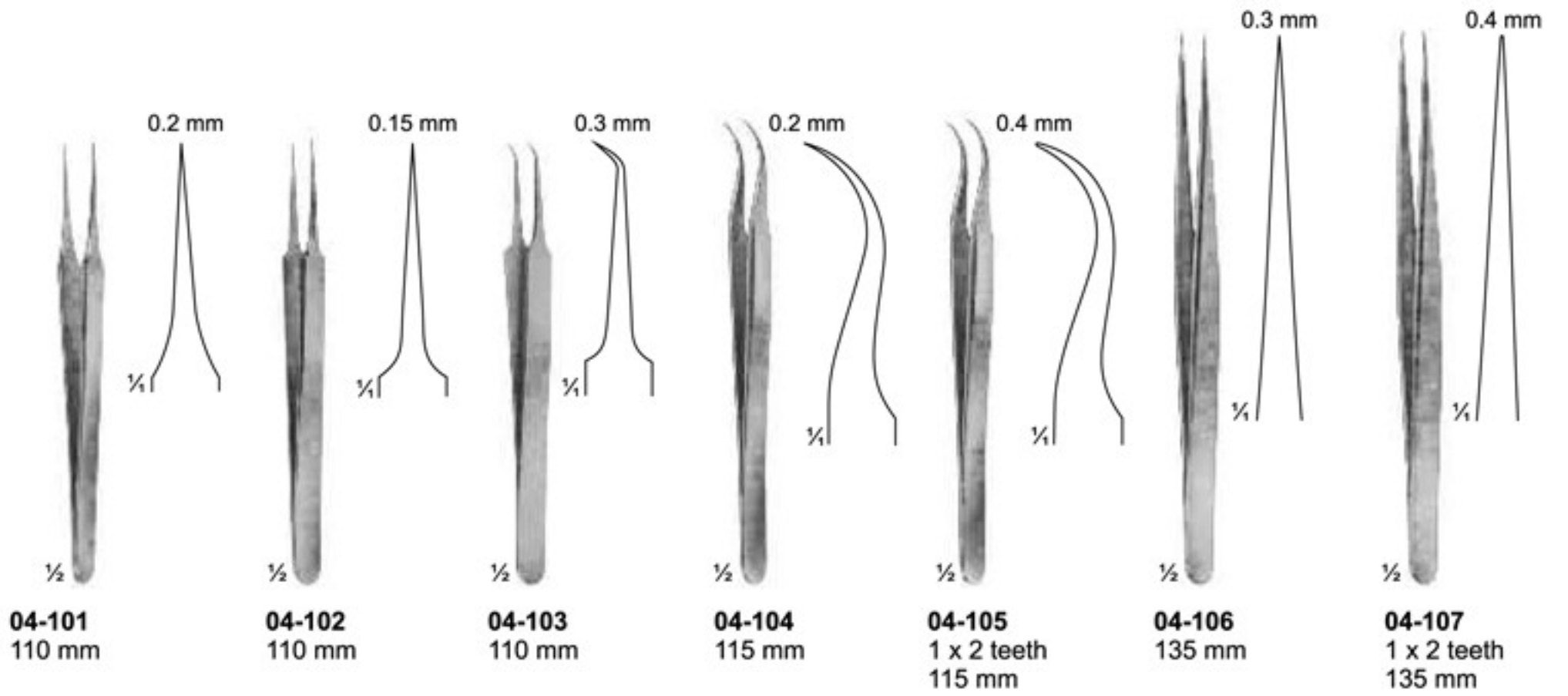

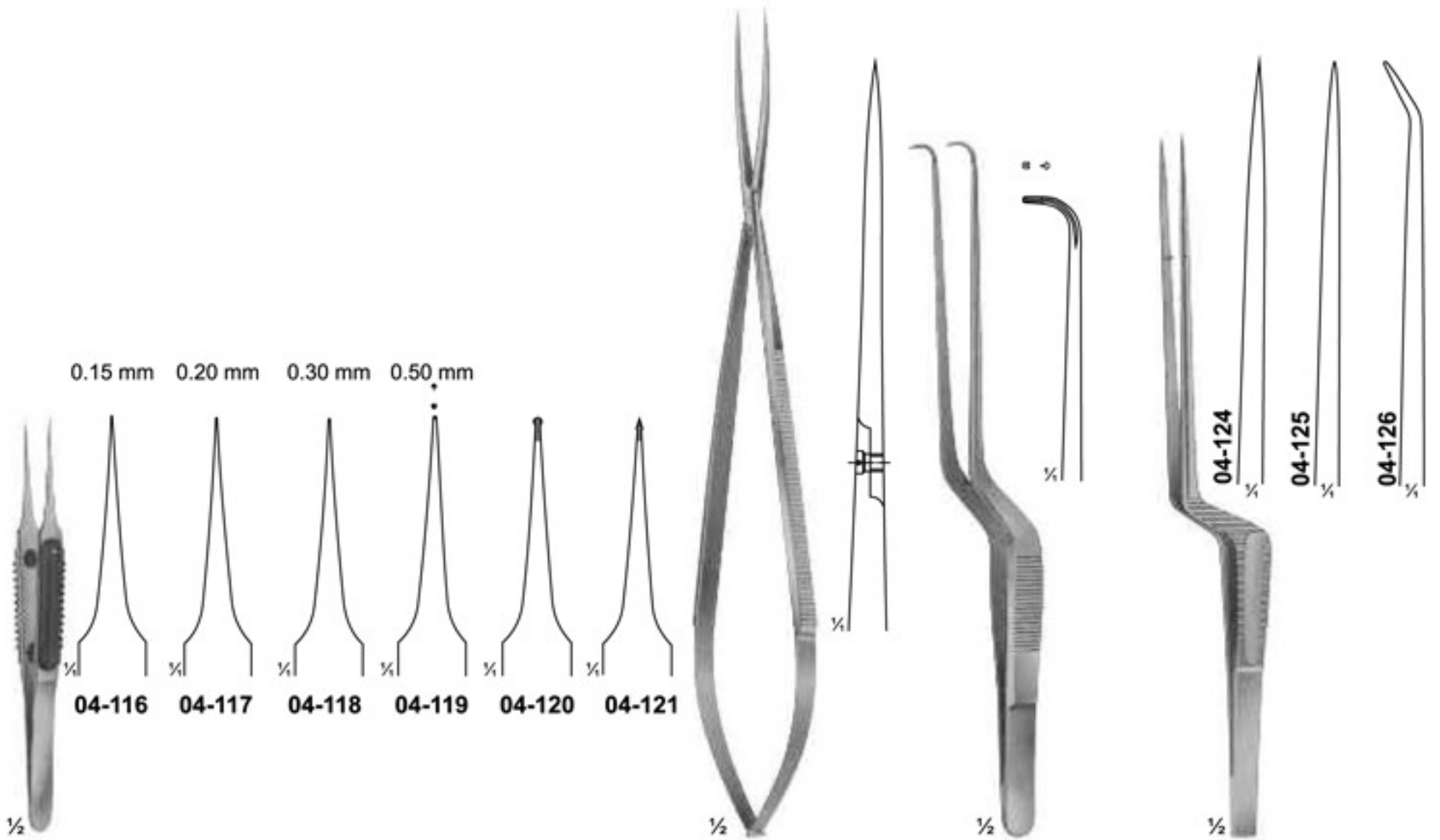

04-116 - 121
MULLER
110 mm

04-122
LIGATURE FORCEPS
220 mm

04-123
YASARGIL
185 mm

04-124 - 126
MICRO FORCEPS
185 mm

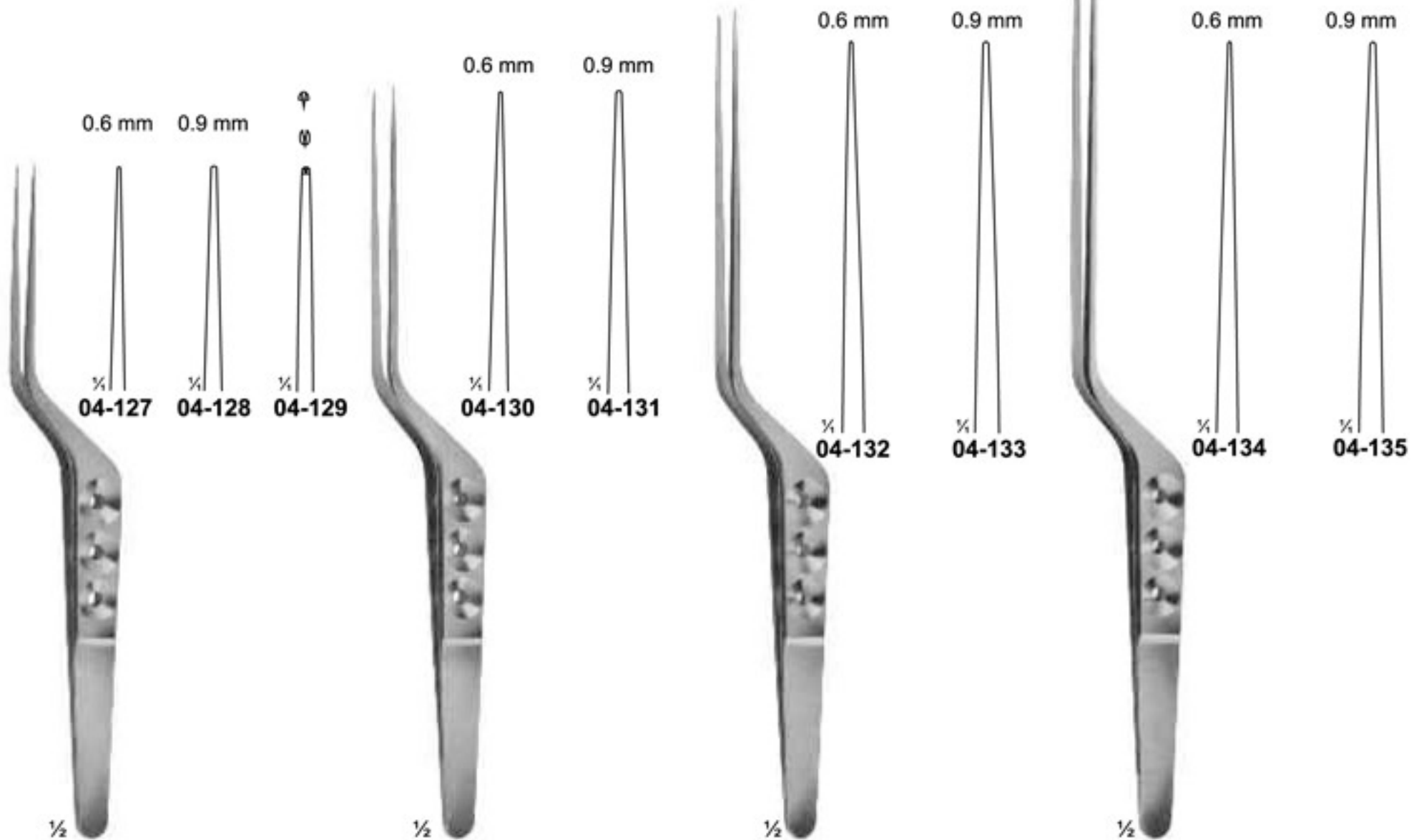

04-127 - 129
YASARGIL
180 mm

04-130 - 131
YASARGIL
200 mm

04-132 - 133
YASARGIL
220 mm

04-134 - 135
YASARGIL
240 mm

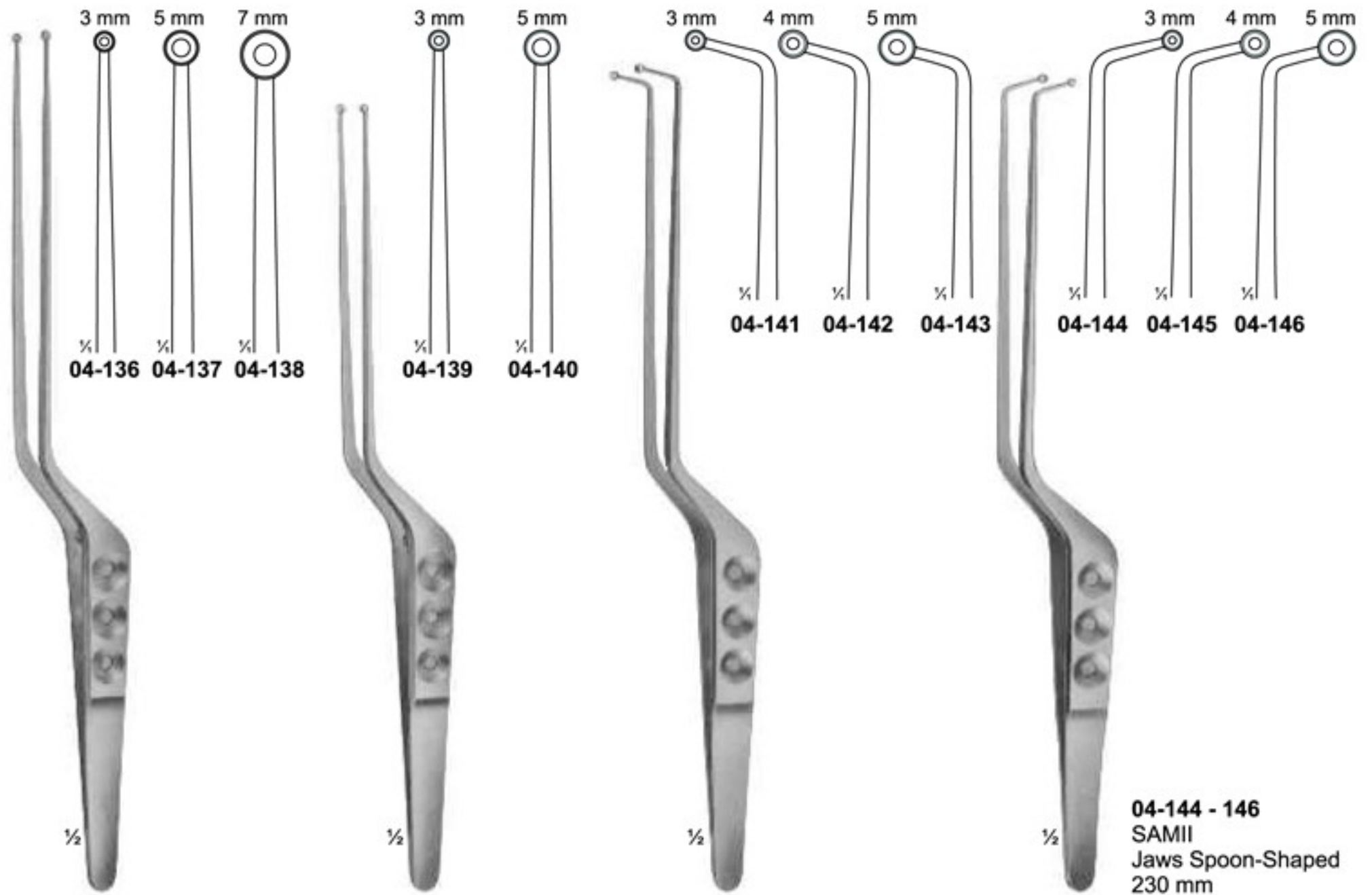

04-136 - 138
 YASARGIL-SAMI
 Jaws Spoon-Shaped
 240 mm

04-139 - 140
 YASARGIL
 Jaws Spoon-Shaped
 220 mm

04-141 - 143
 SAMII
 Jaws Spoon-Shaped
 230 mm

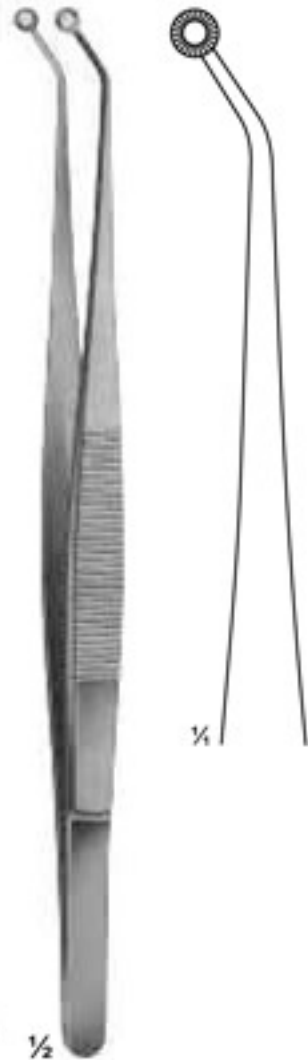

04-147
 HUNT
 Tumor-and Vessel Forceps
 200 mm



04-148
 HUNT
 Tumor-and Vessel Forceps
 200 mm



04-149
 YASARGIL
 Tumor-and Vessel Forceps
 200 mm

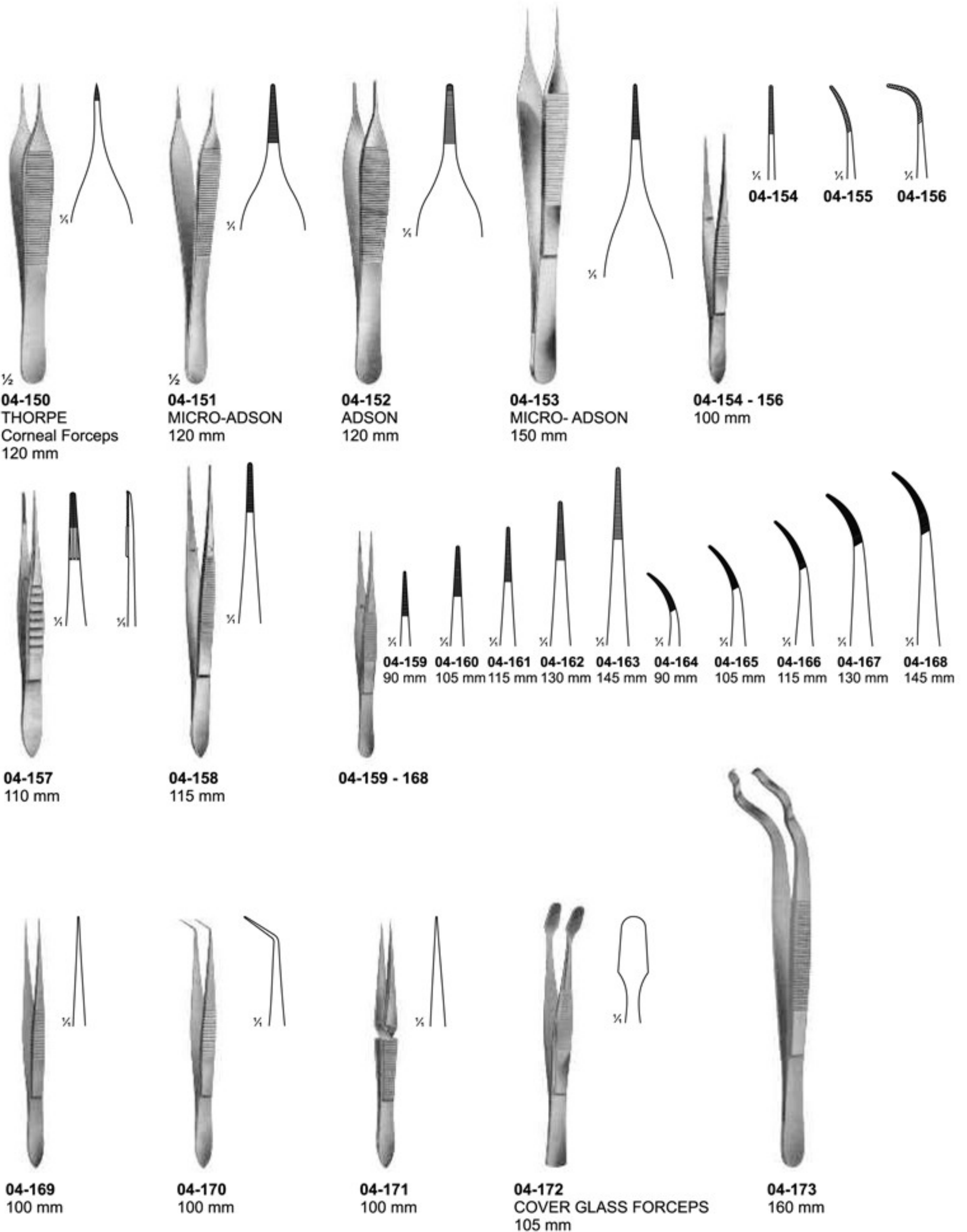

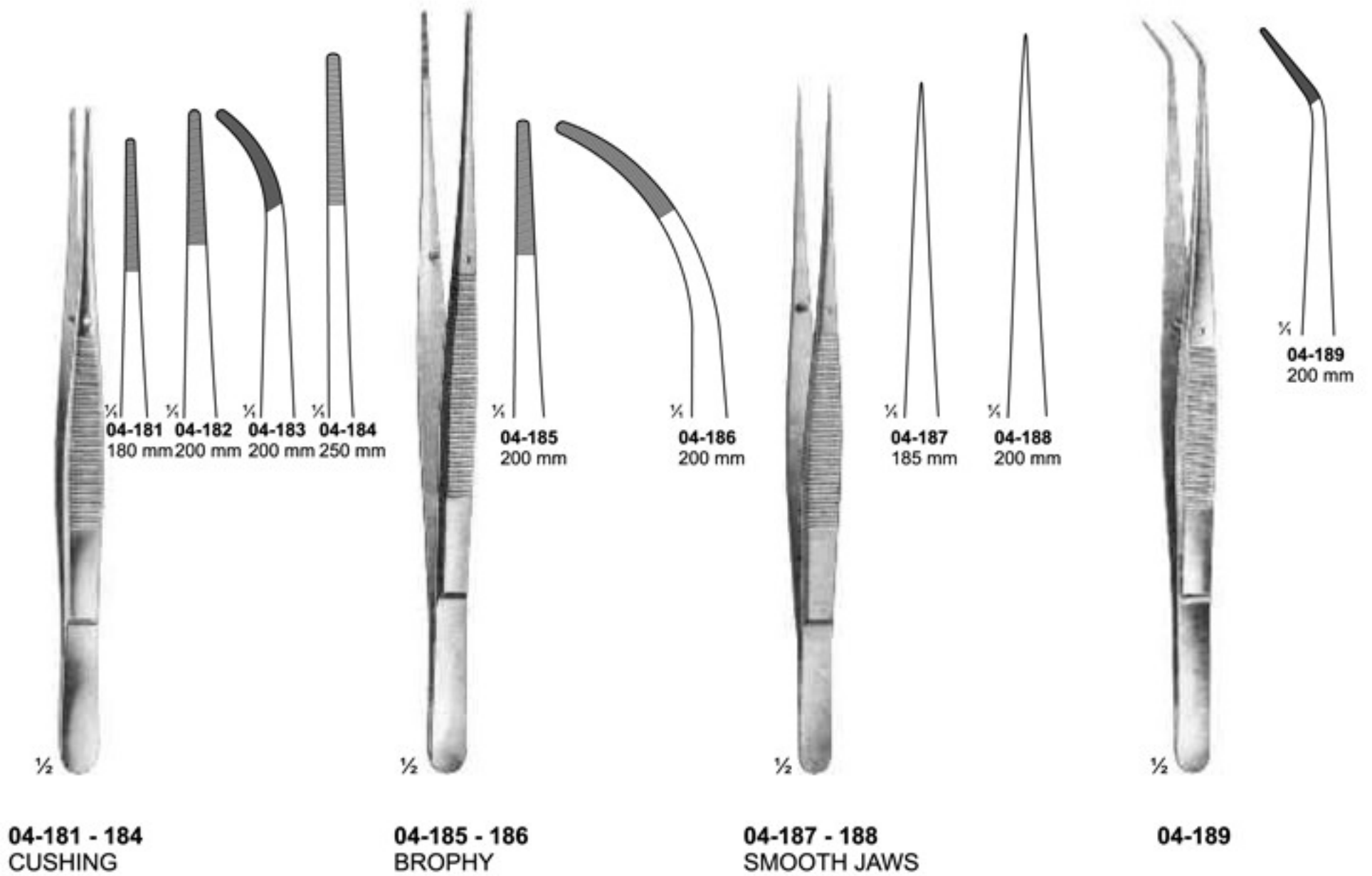
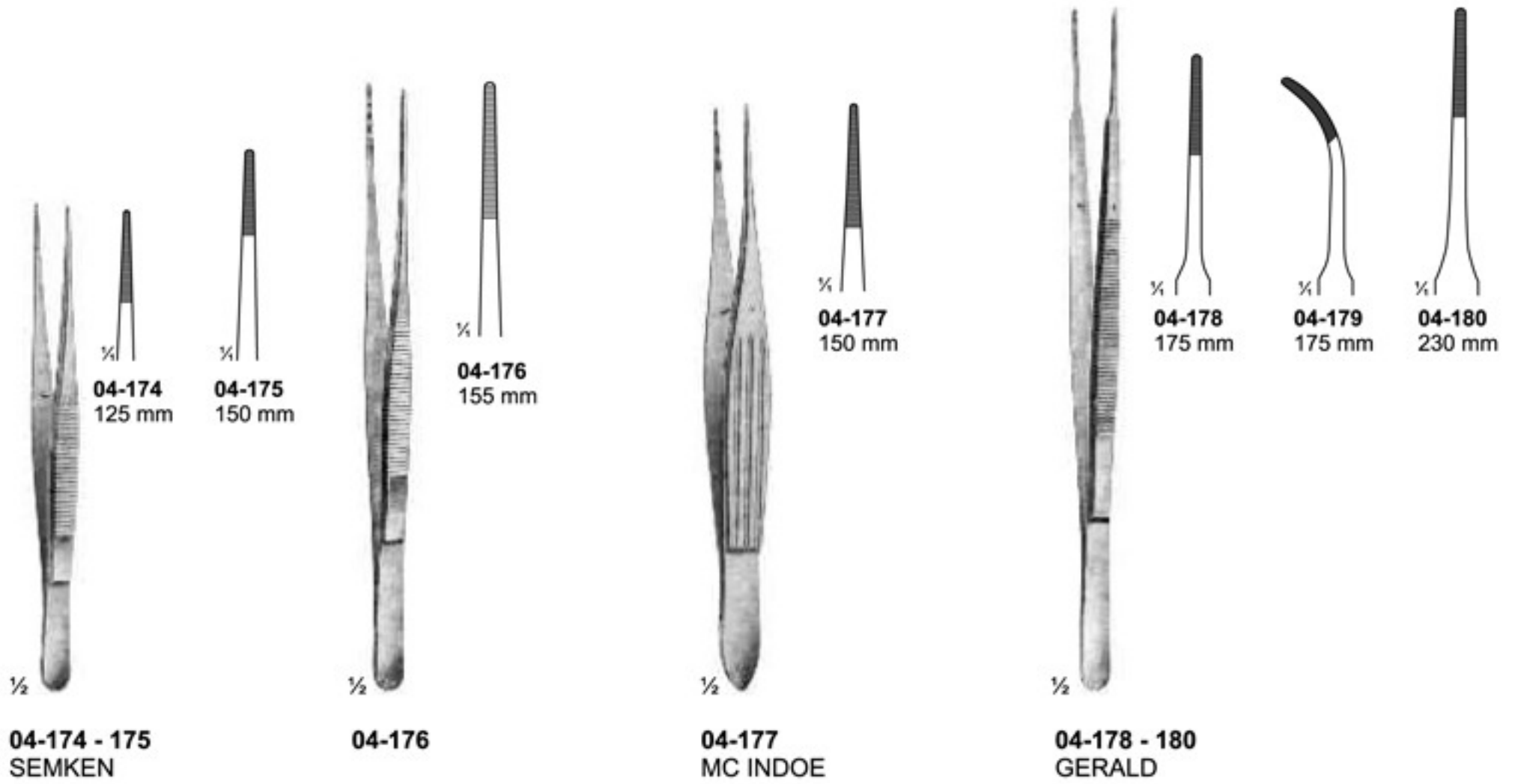

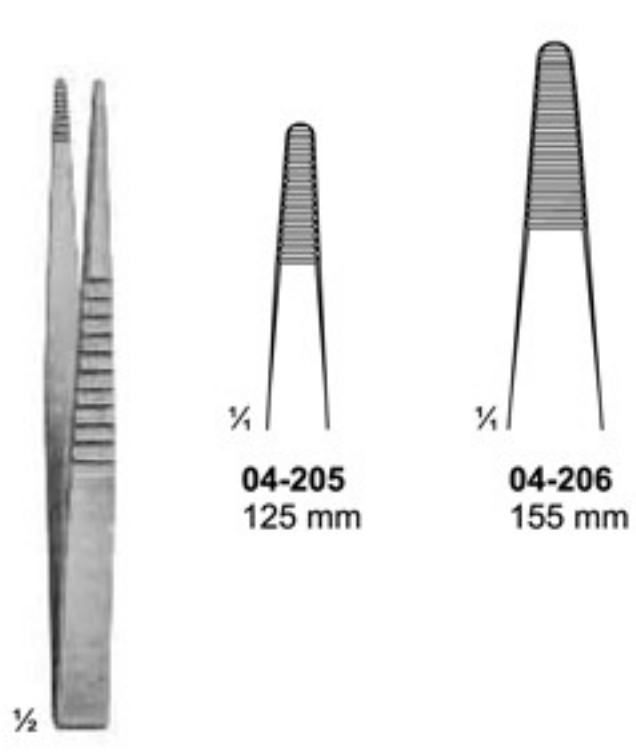

04-205
125 mm

04-206
155 mm

04-205 - 206

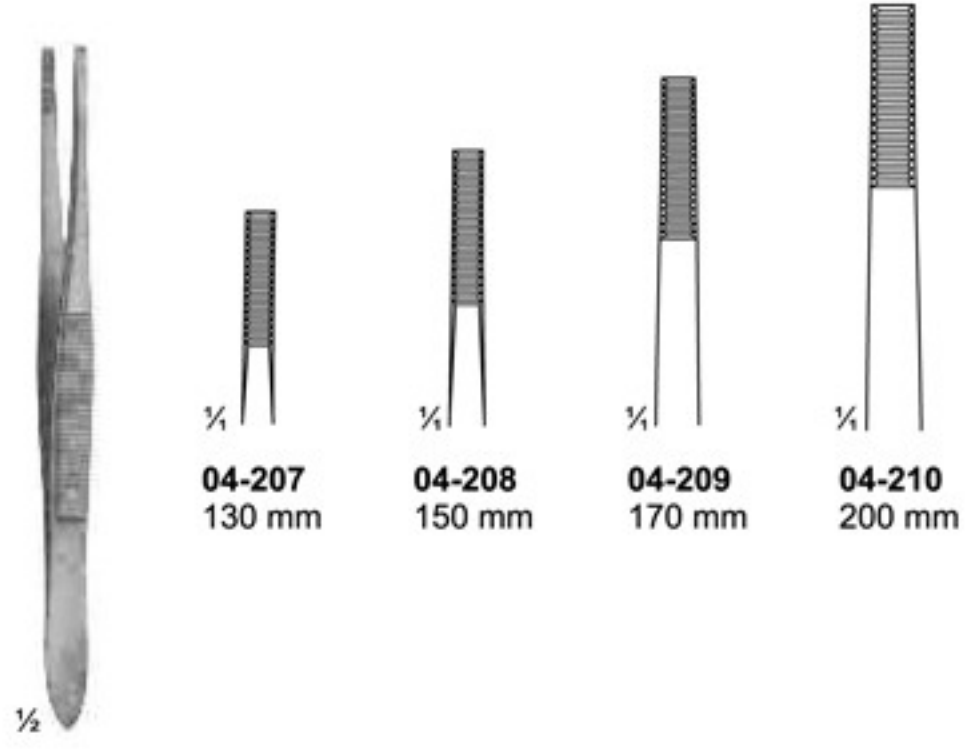

04-207
130 mm

04-208
150 mm

04-209
170 mm

04-210
200 mm

04-207 - 210

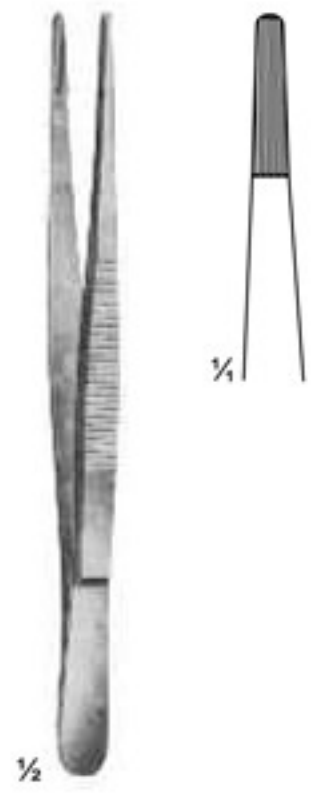

04-211
OCHSNER

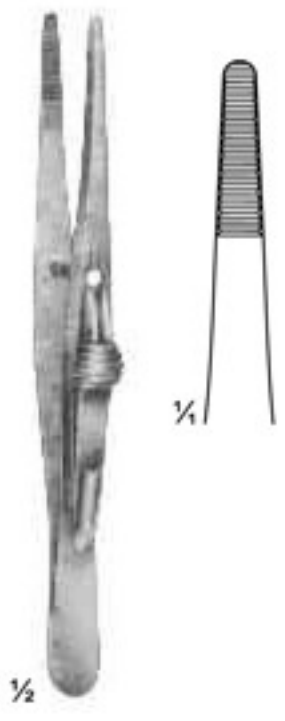

04-212
FRICKE

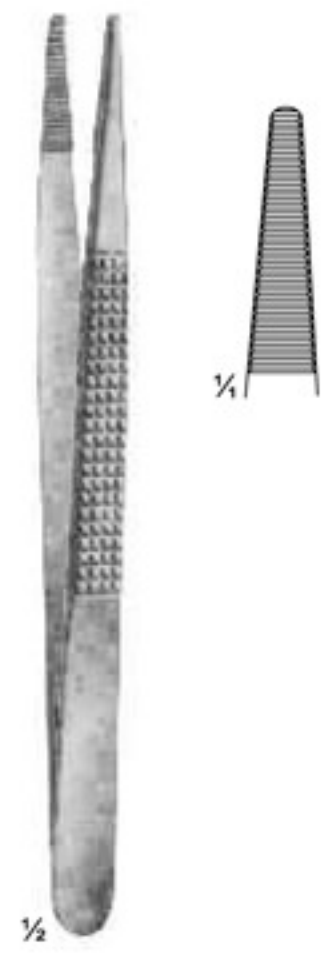

04-213
BONNEY

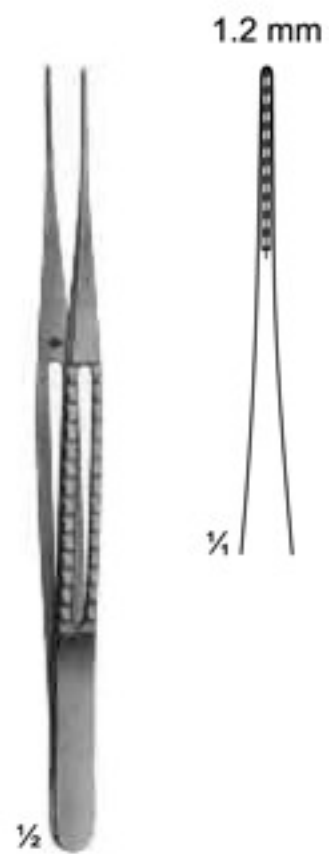

04-214
150 mm

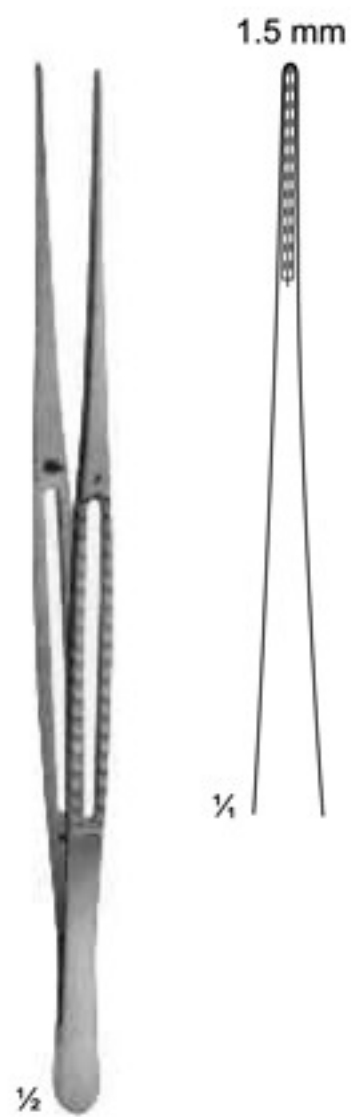

04-215
200 mm

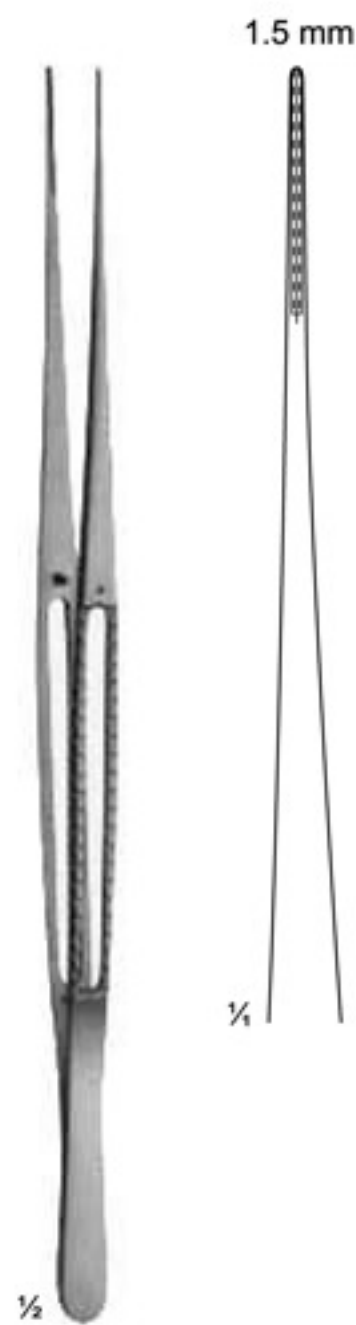

04-216
240 mm

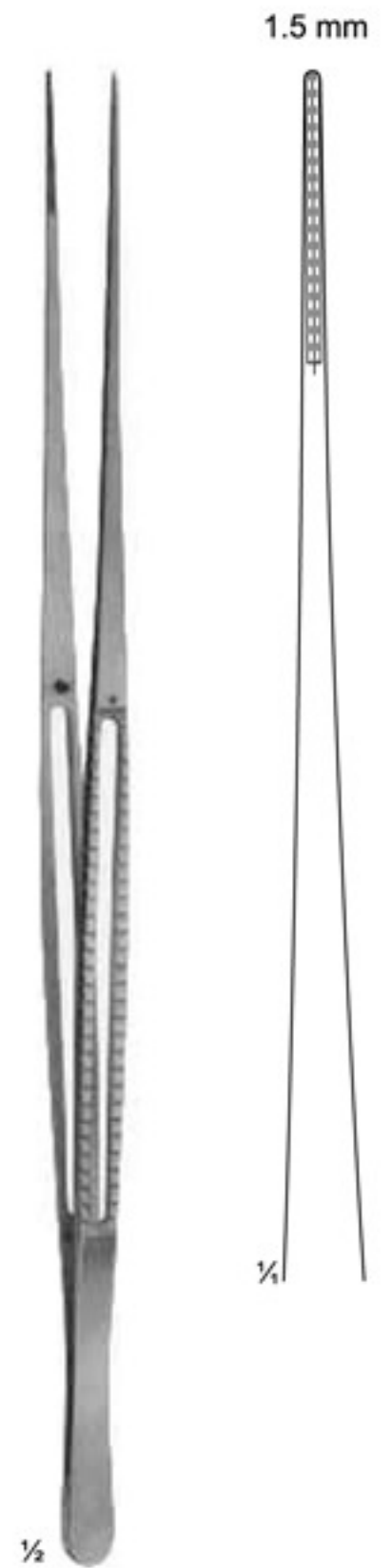

04-217
300 mm

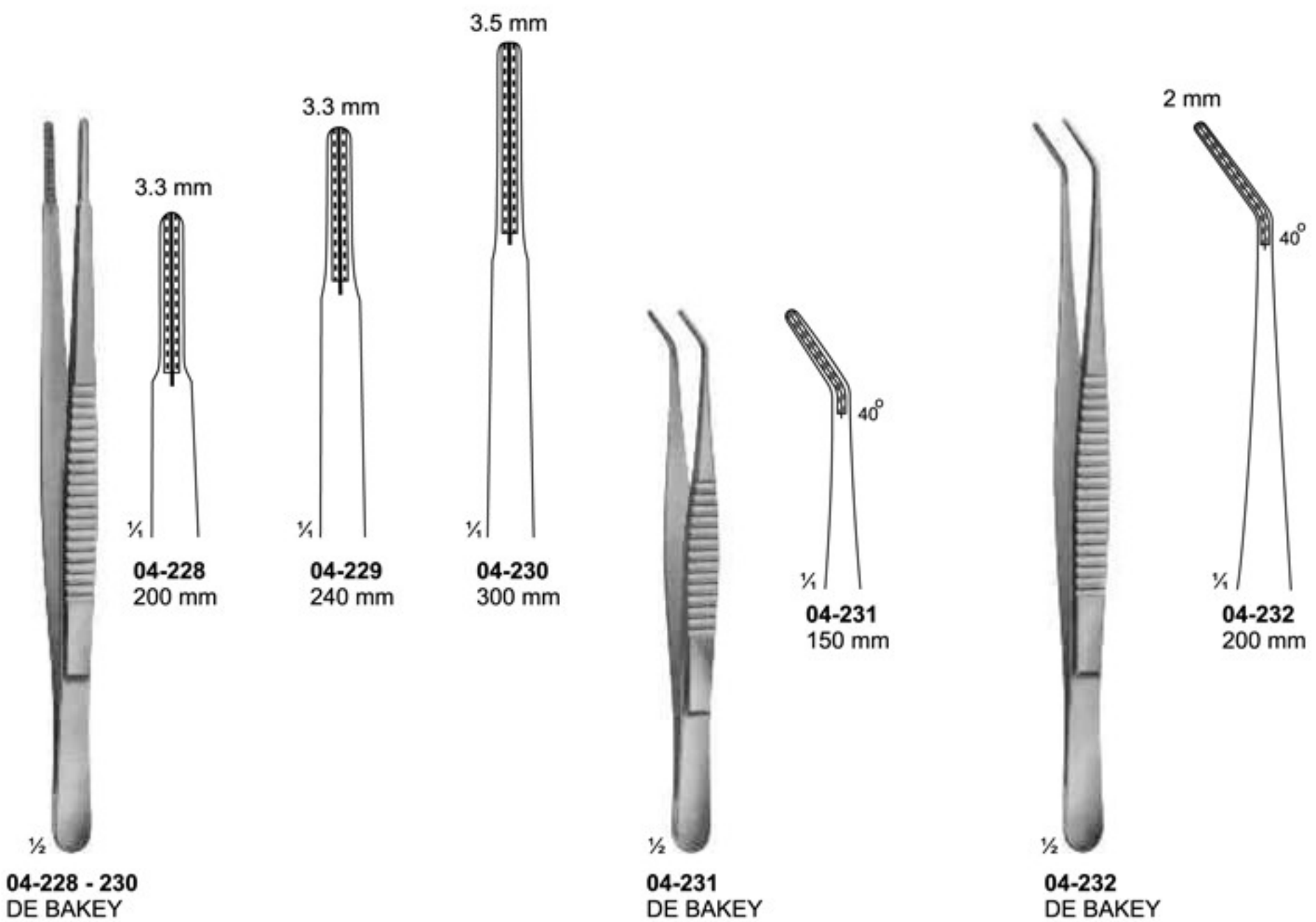
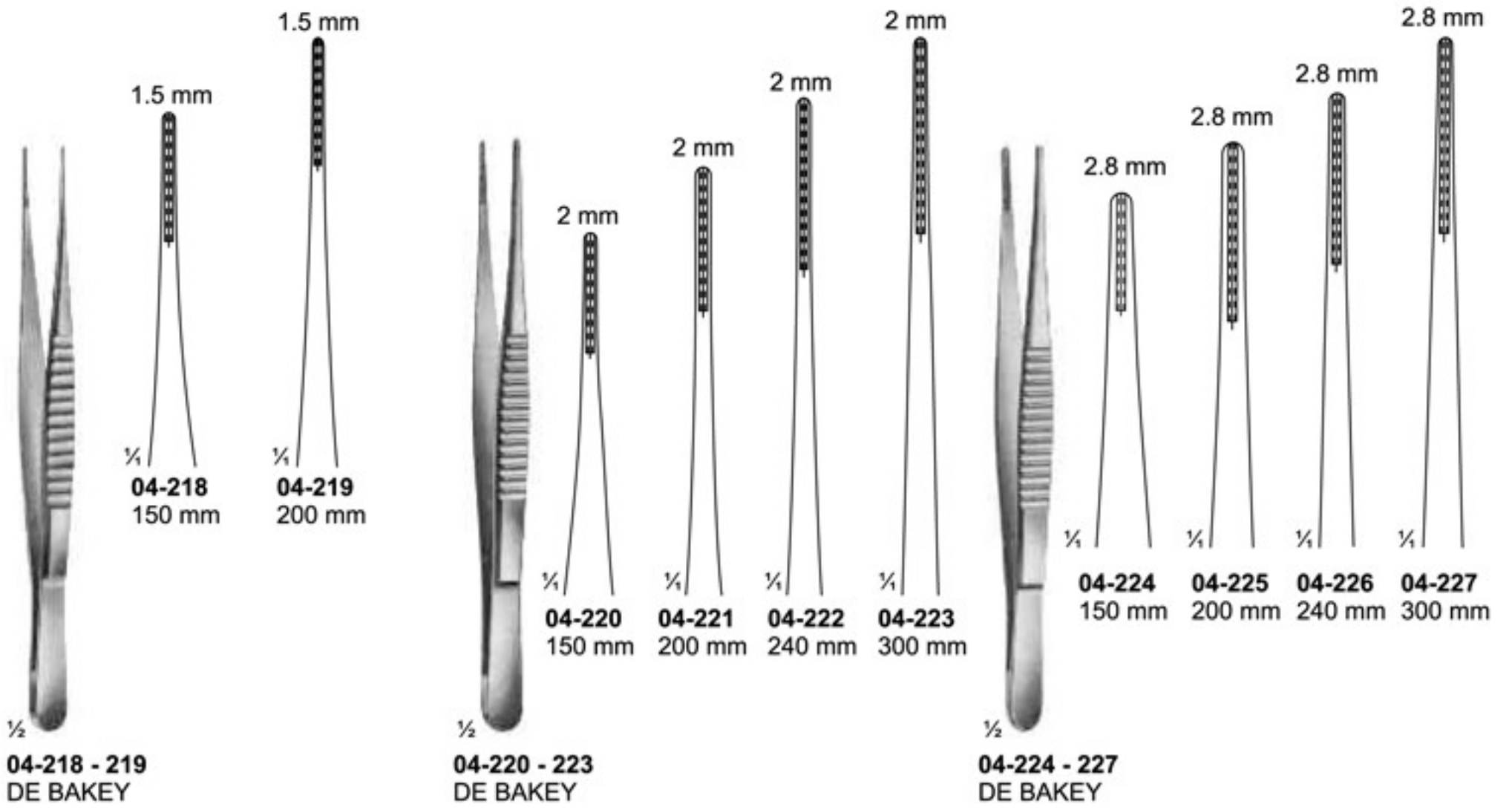

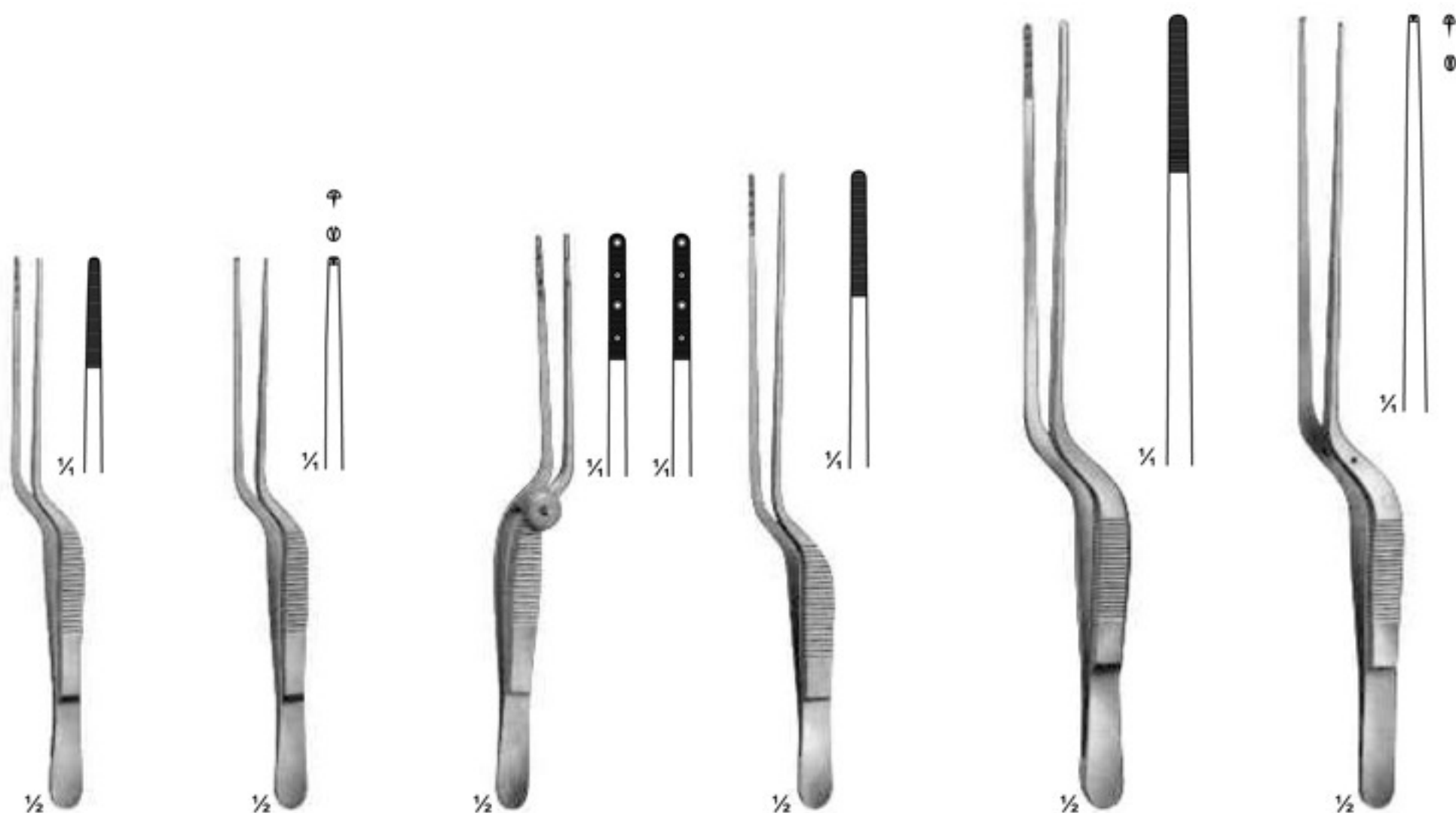

04-233
LUCAE
140 mm

04-234
LUCAE
1x2 teeth
140 mm

04-235
COTTLE
Forceps with
jaws toothed
and serrated
140 mm

04-236
JANSEN
160 mm

04-237
GRUENWALD
200 mm

04-238
1x2 teeth
200 mm

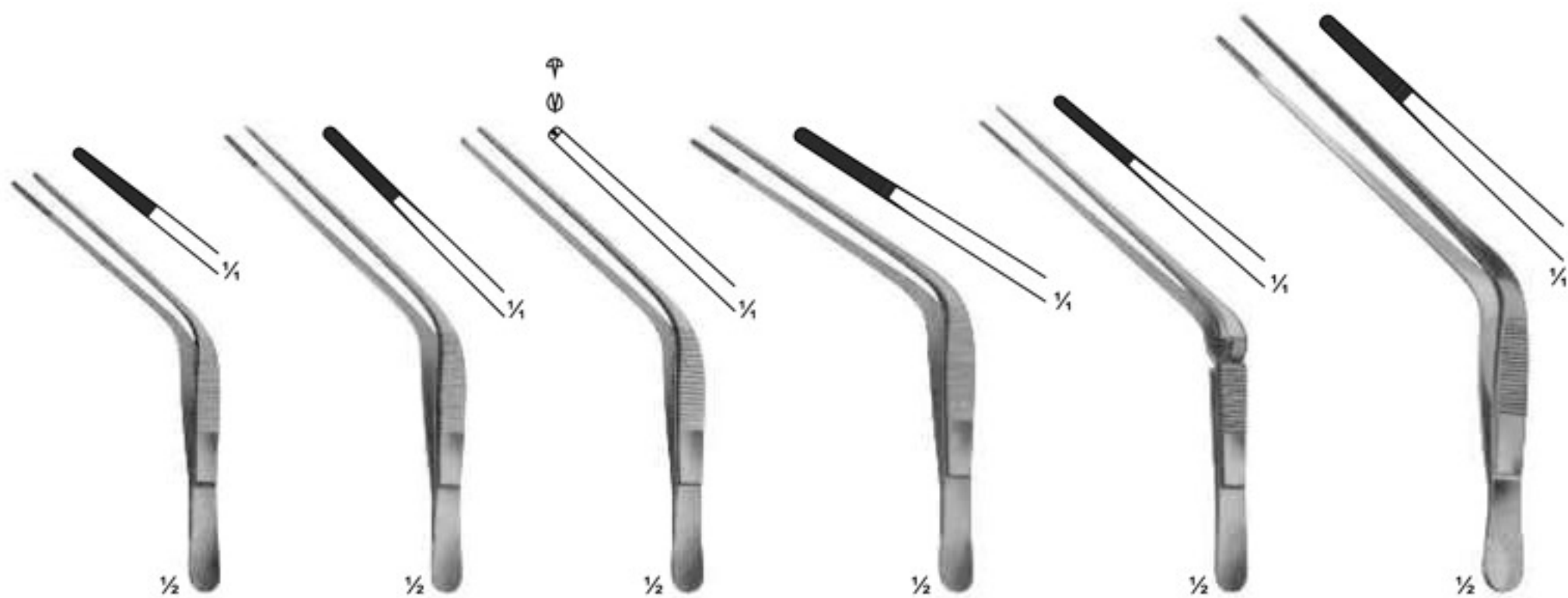

04-239
TROELTSCH
100 mm

04-240
TROELTSCH
115 mm

04-241
TROELTSCH
1X2 teeth
115 mm

04-242
WILDE
115 mm

04-243
TROELTSCH
Cross action
120 mm

04-244
TROELTSCH
140 mm

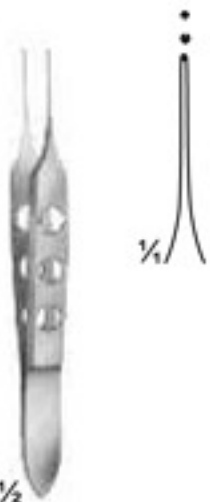

04-245
BISHOP-HARMON
85 mm

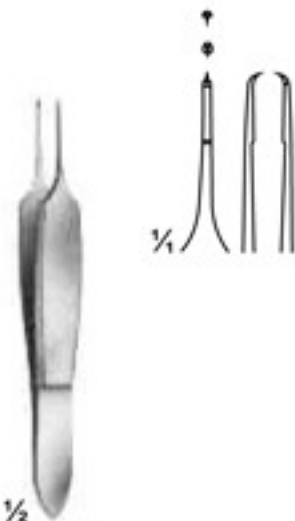

04-246
ST. MARTIN
80 mm

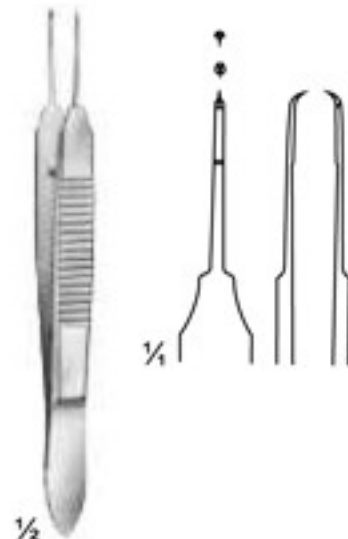

04-247
CASTROVIEJO
teeth 0.9 mm
100 mm

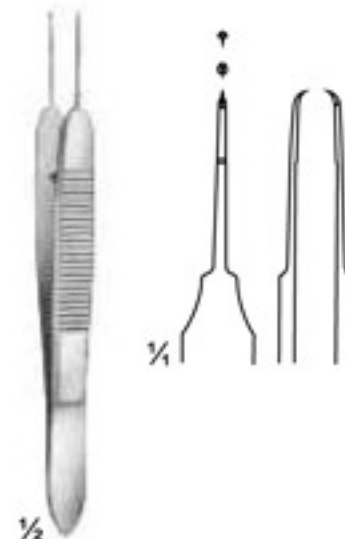

04-248
CASTROVIEJO
teeth 0.5 mm
100 mm

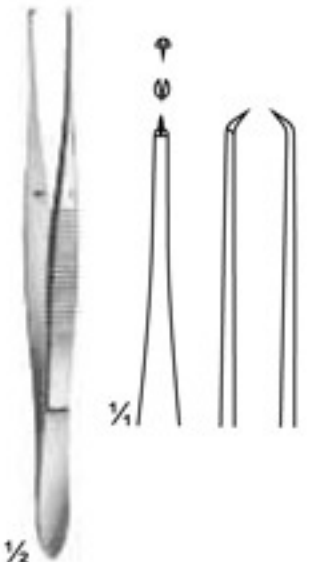

04-249
ELSCHING
110 mm

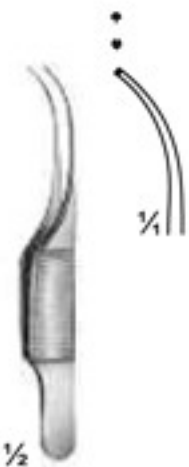

04-250
GILL
75 mm

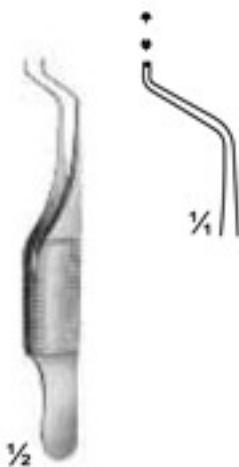

04-251
GILL - HESS
75 mm

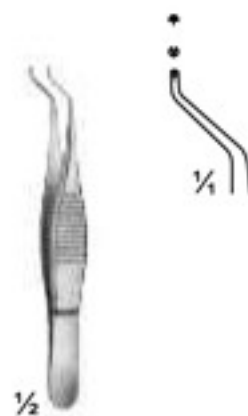

04-252
HESS
70 mm

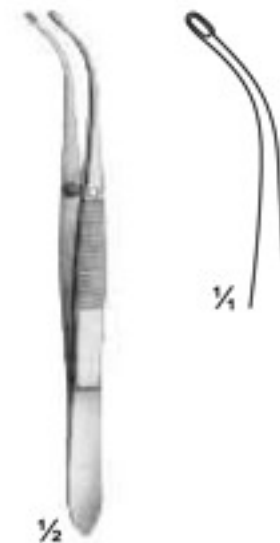

04-253
ARRUGA
100 mm

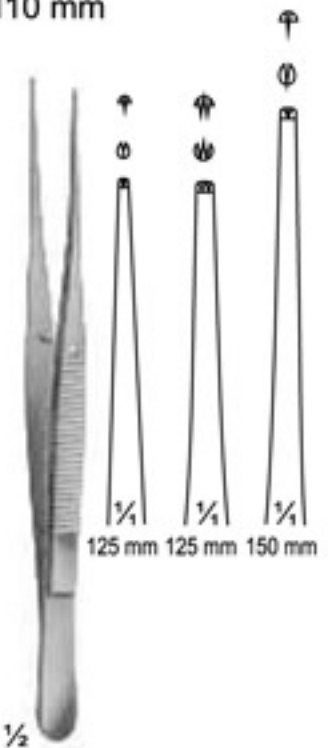

04-254
SEMKEN
125 mm 125 mm 150 mm

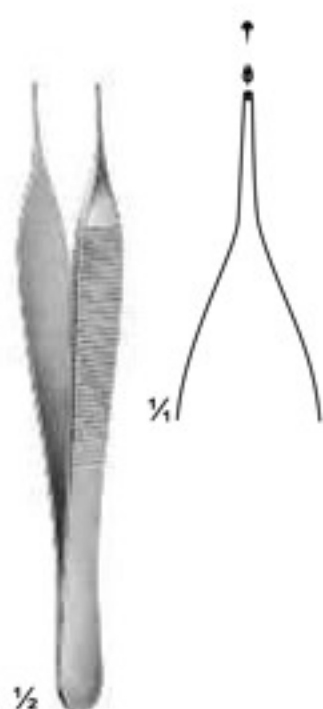

04-255
MICRO-ADSON
120 mm

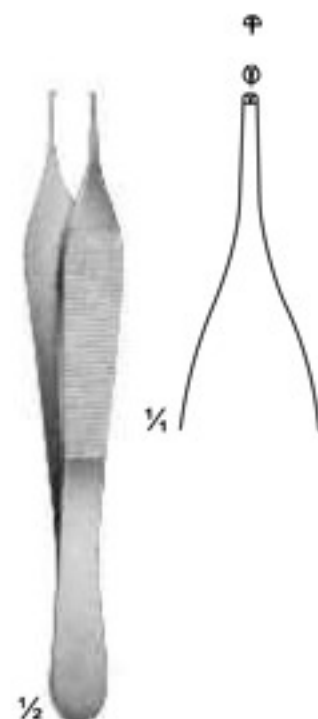

04-256
ADSON
120 mm

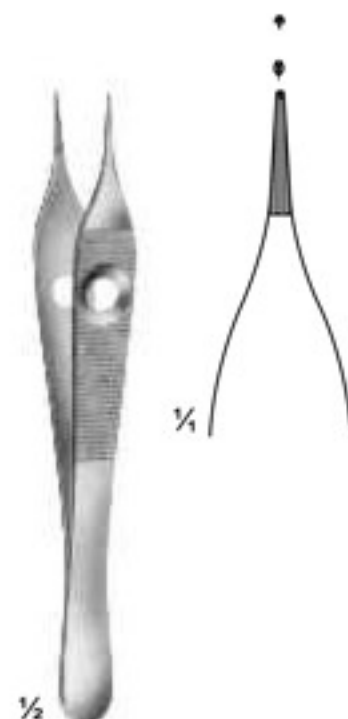

04-257
ADSON
120 mm



04-258
ADSON
120 mm

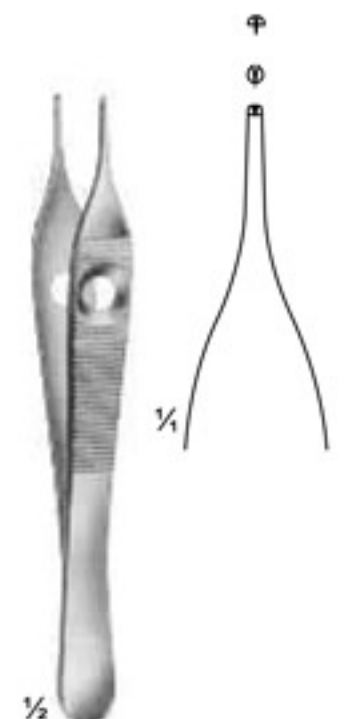

04-259
ADSON
150 mm

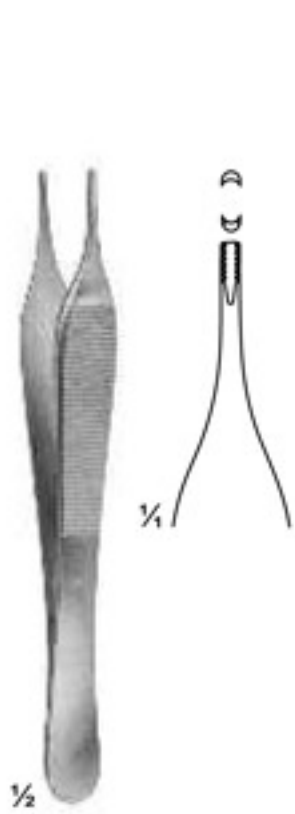

04-260
ADSON - BROWN
Non-traumatic
120 mm

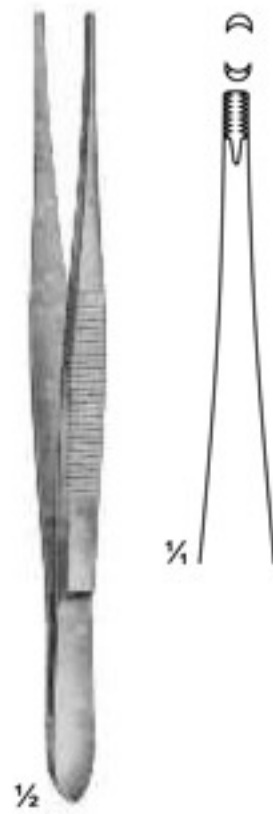

04-261
BROWN
120 mm

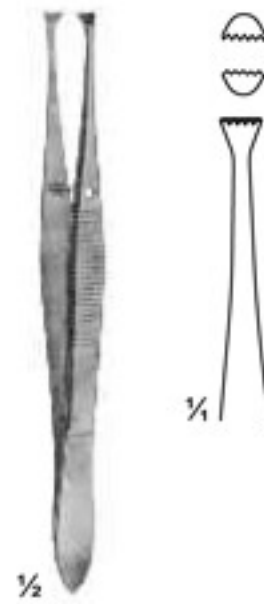

04-262
GRAEFE
110 mm

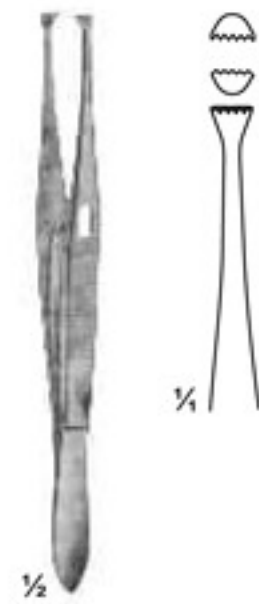

04-263
GRAEFE
With Catch
110 mm

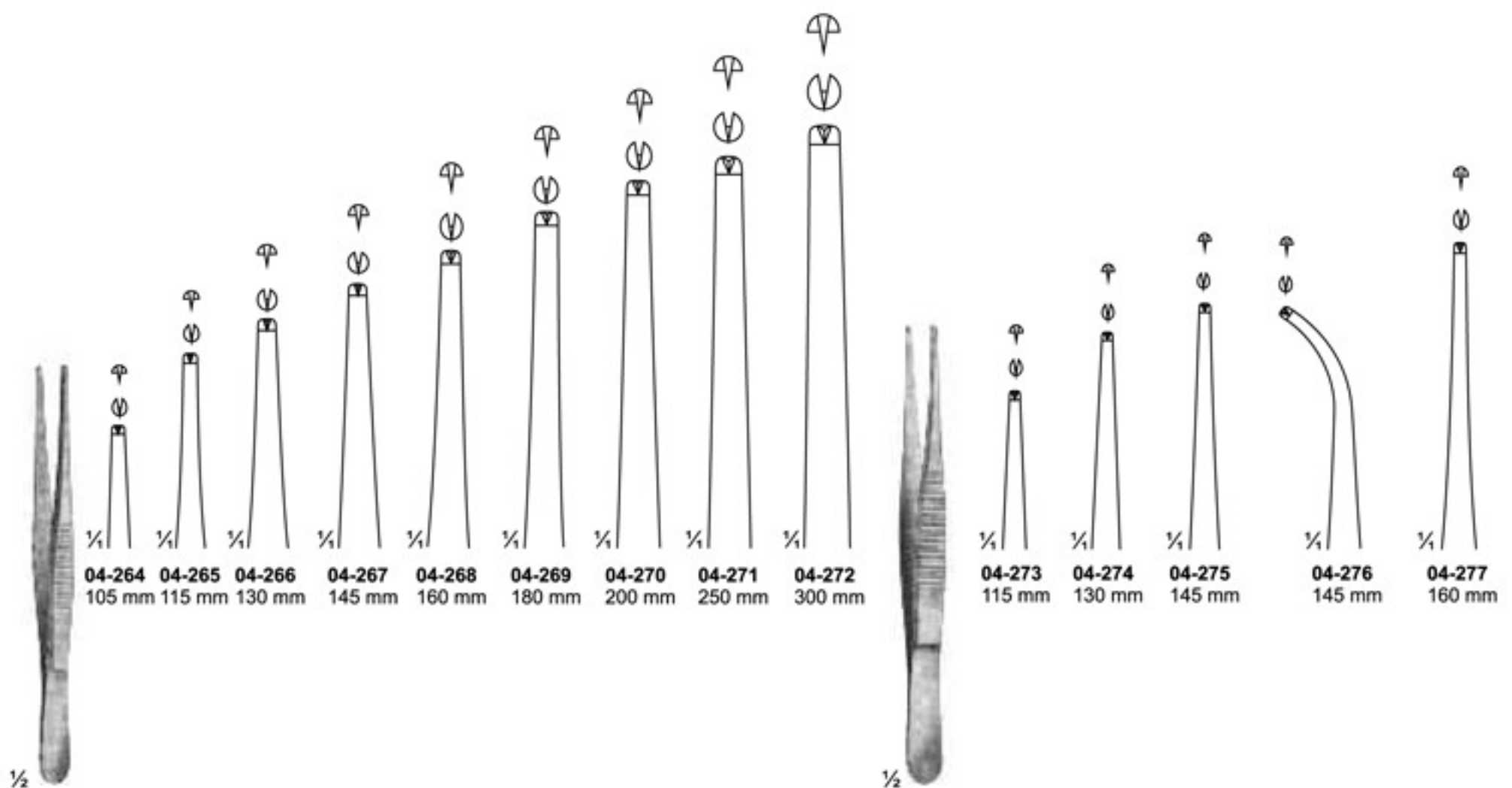

04-264 - 272
STANDARD

04-273 - 277
GRAEFE
110 mm

- 04-264
105 mm
- 04-265
115 mm
- 04-266
130 mm
- 04-267
145 mm
- 04-268
160 mm
- 04-269
180 mm
- 04-270
200 mm
- 04-271
250 mm
- 04-272
300 mm
- 04-273
115 mm
- 04-274
130 mm
- 04-275
145 mm
- 04-276
145 mm
- 04-277
160 mm

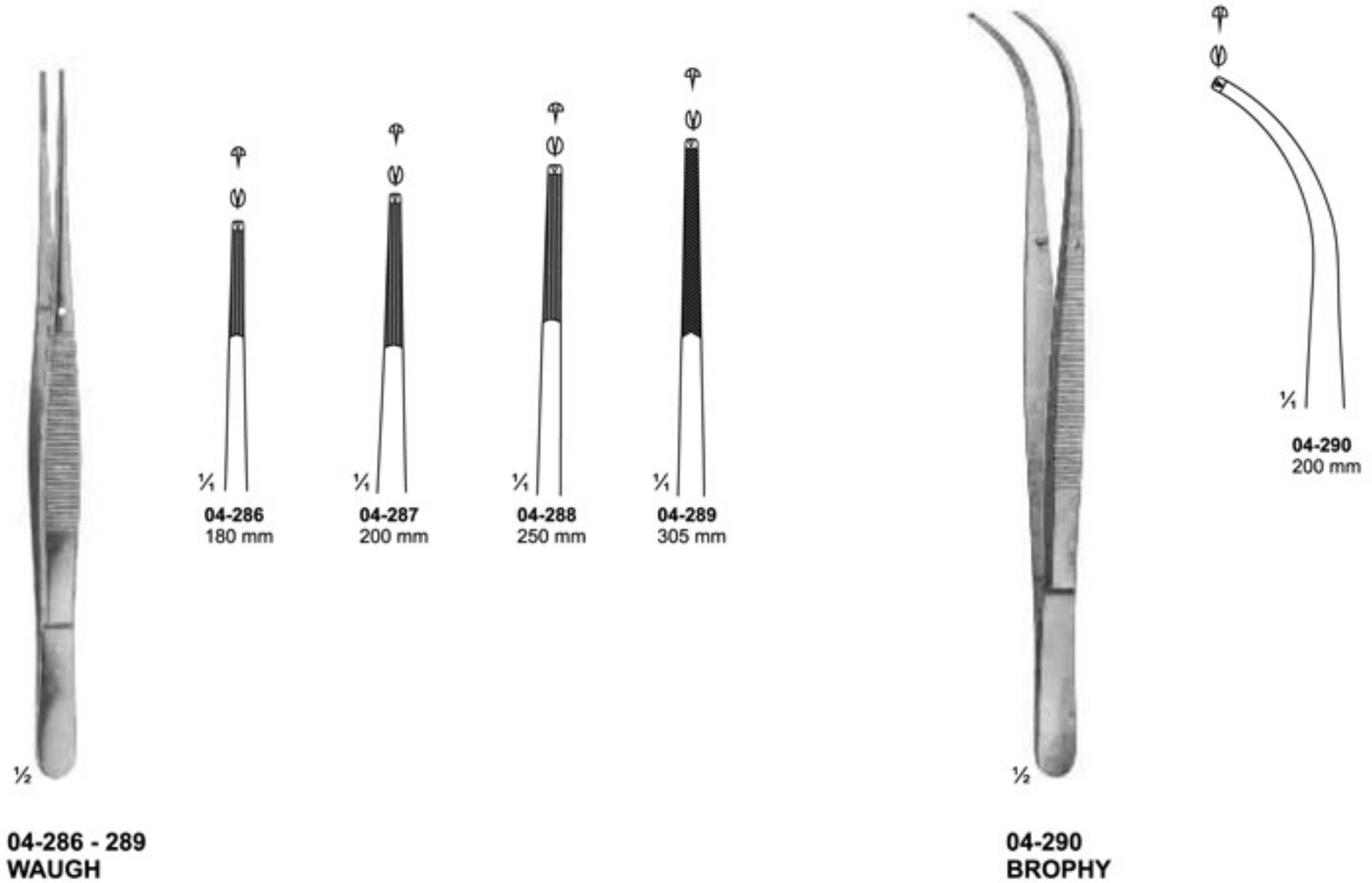
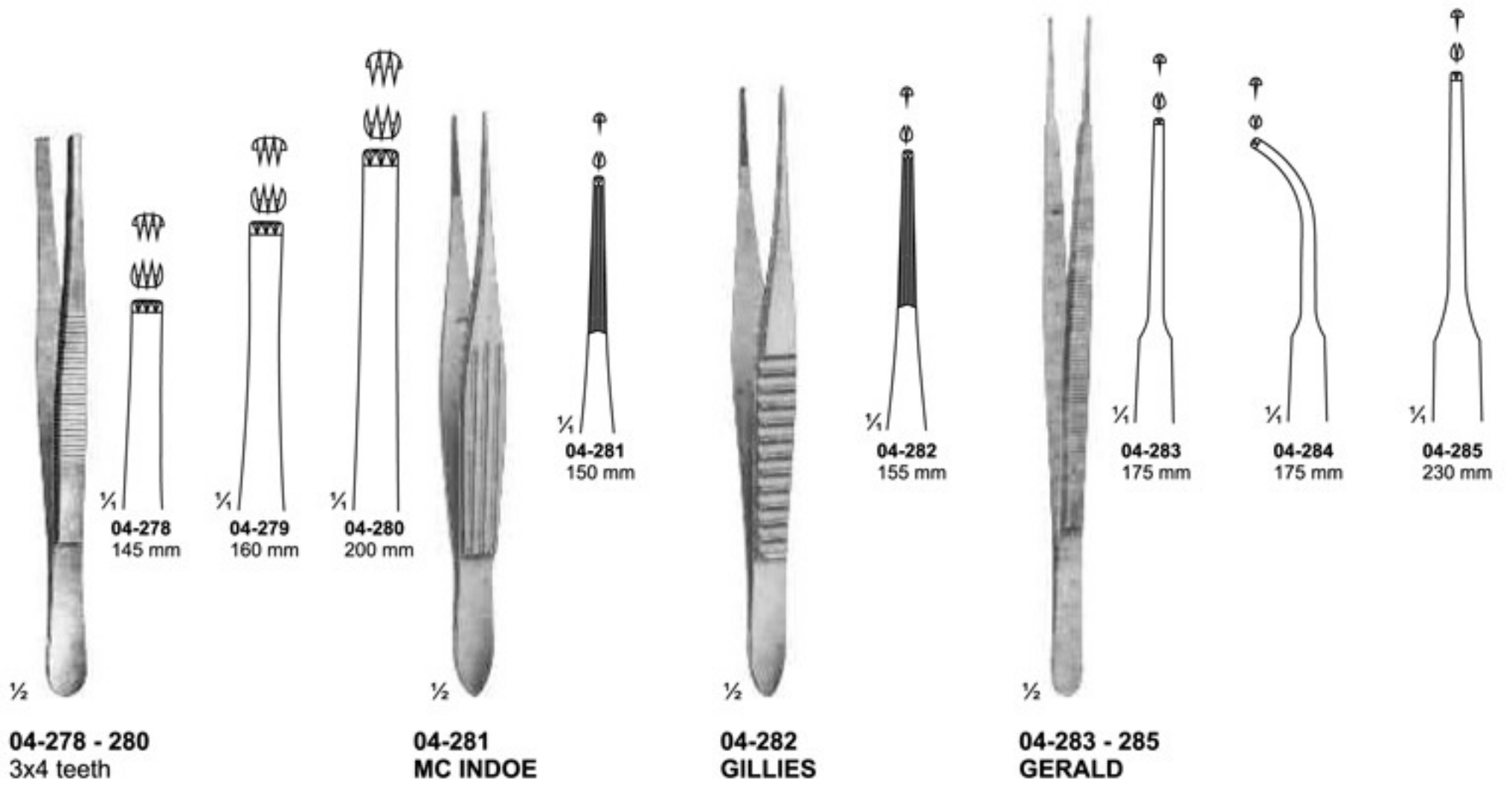

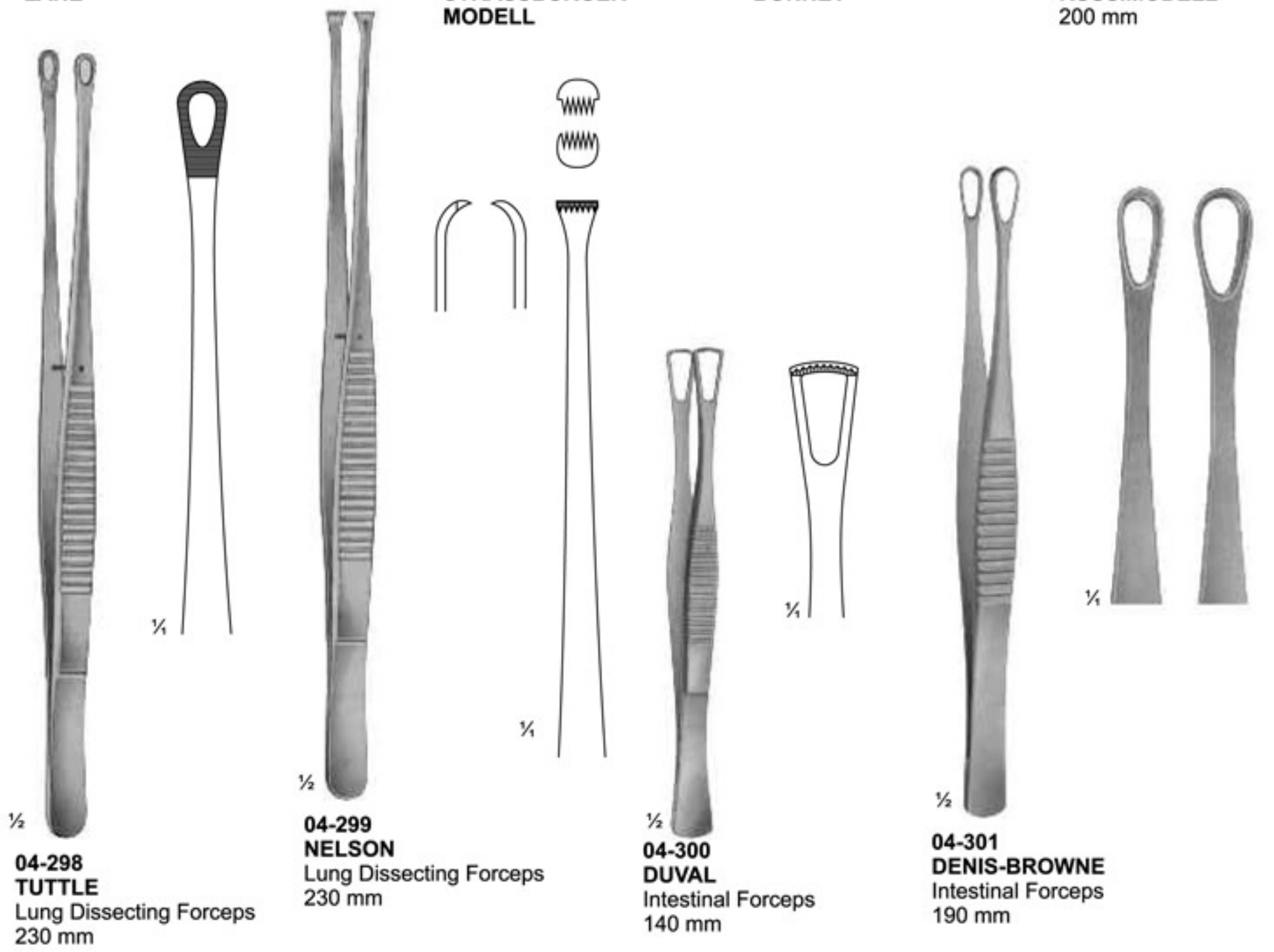
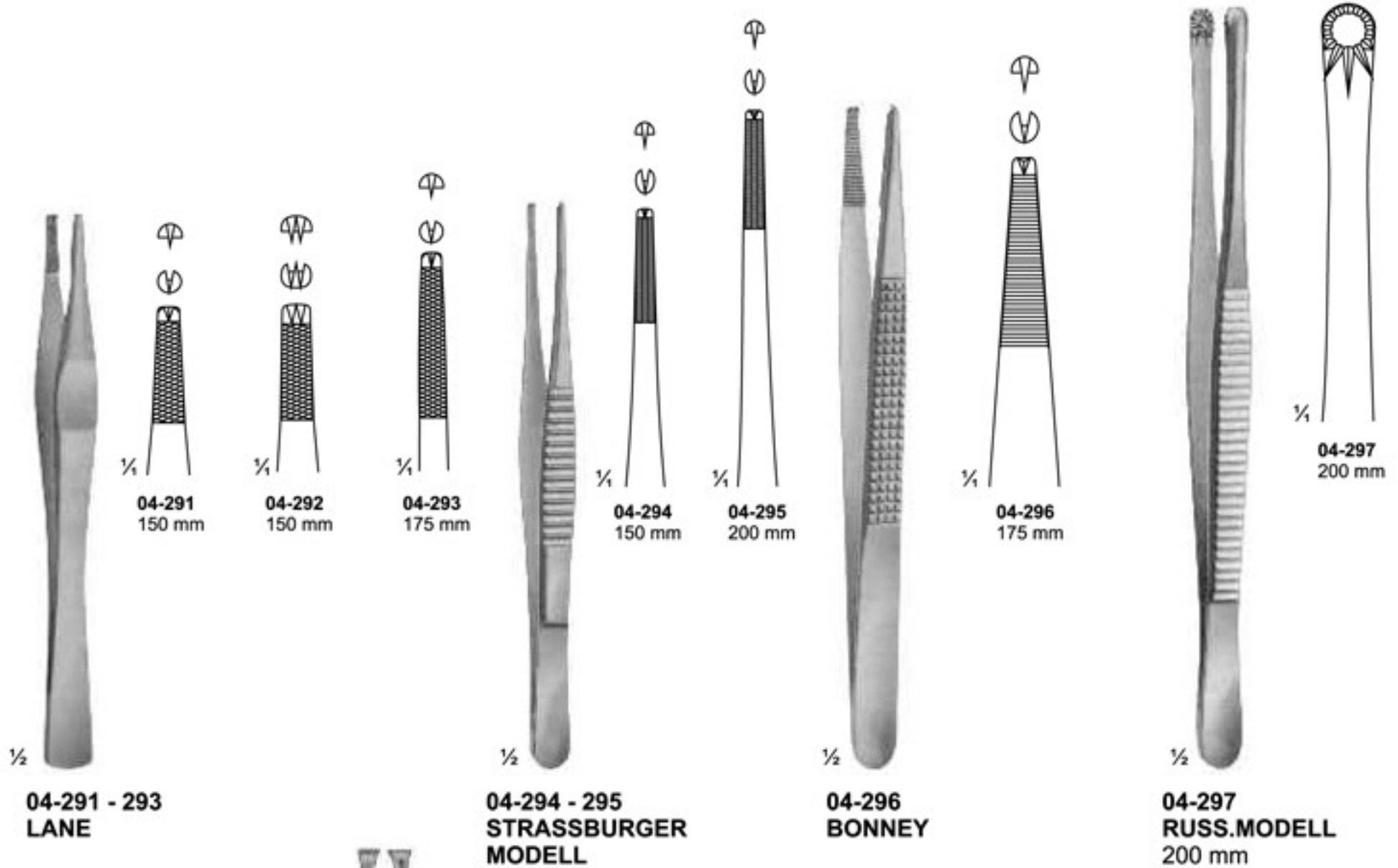

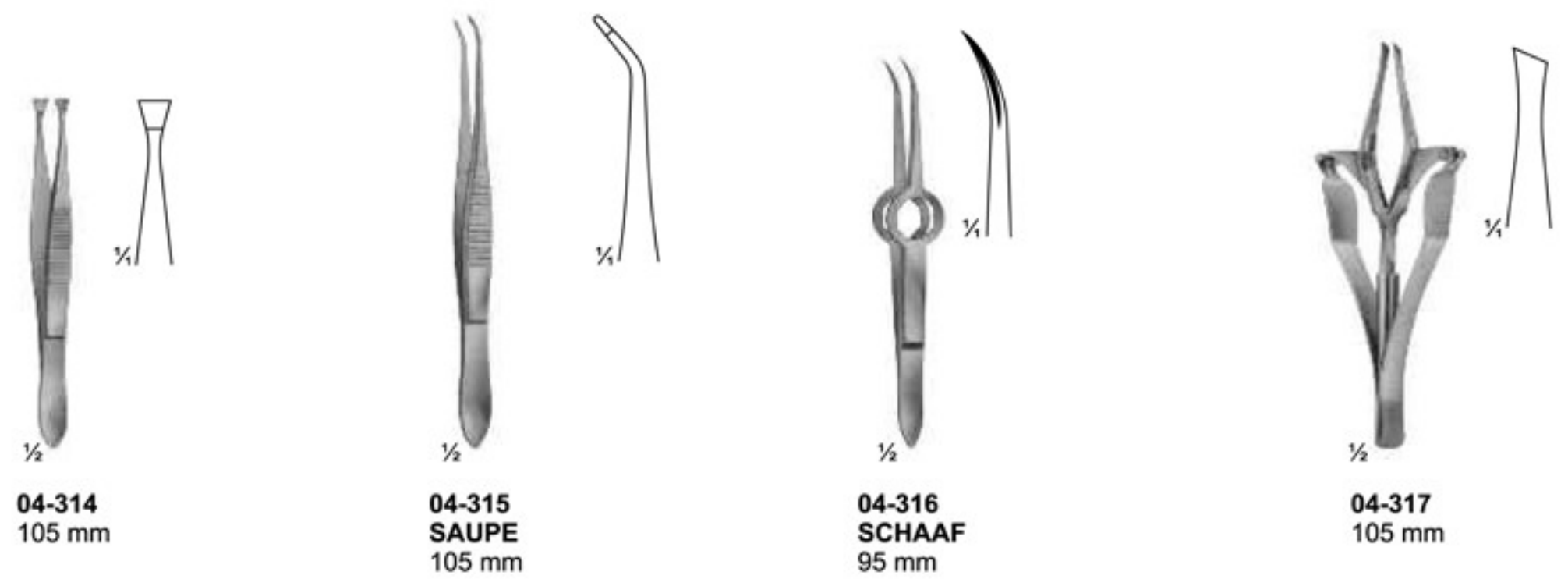
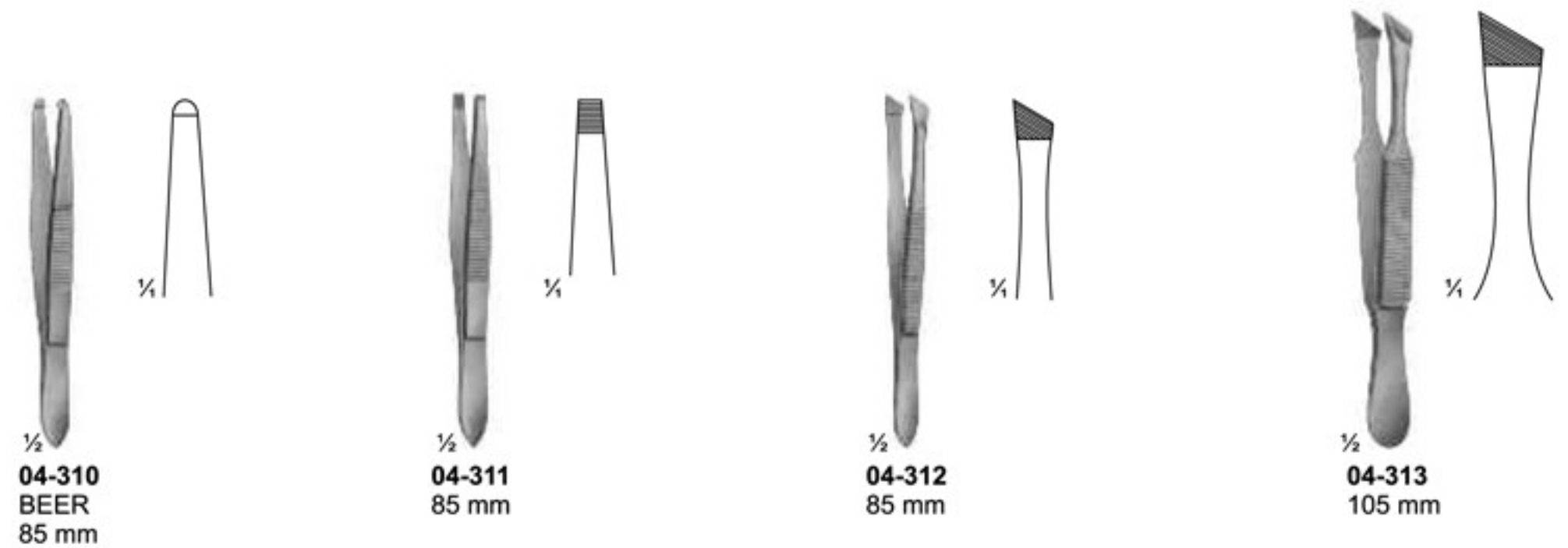
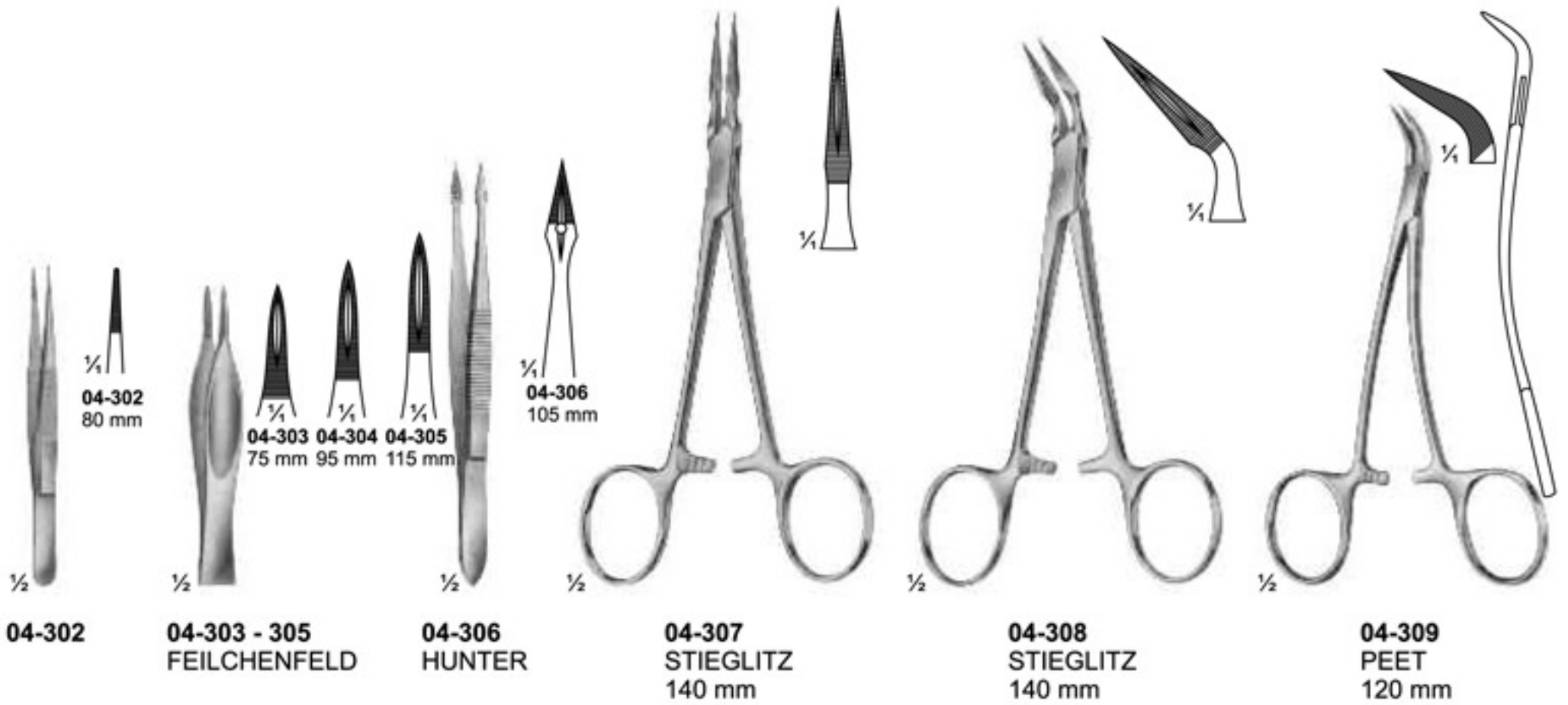

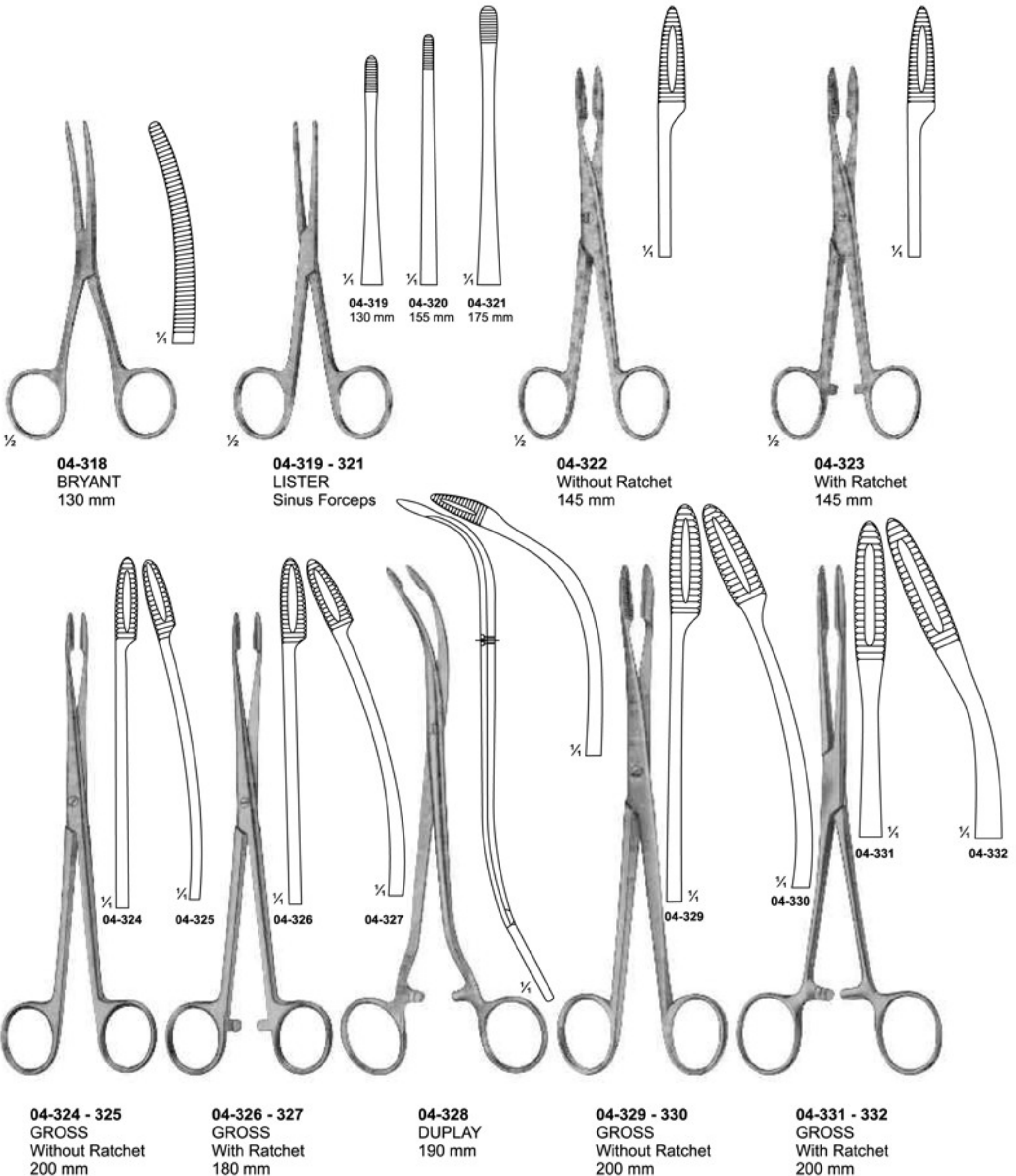



04-333 - 334
AESCULAP
 220 mm

04-335 - 336
MAIER
 Without Ratchet
 265 mm

04-337 - 338
MAIER
 With Ratchet
 265 mm

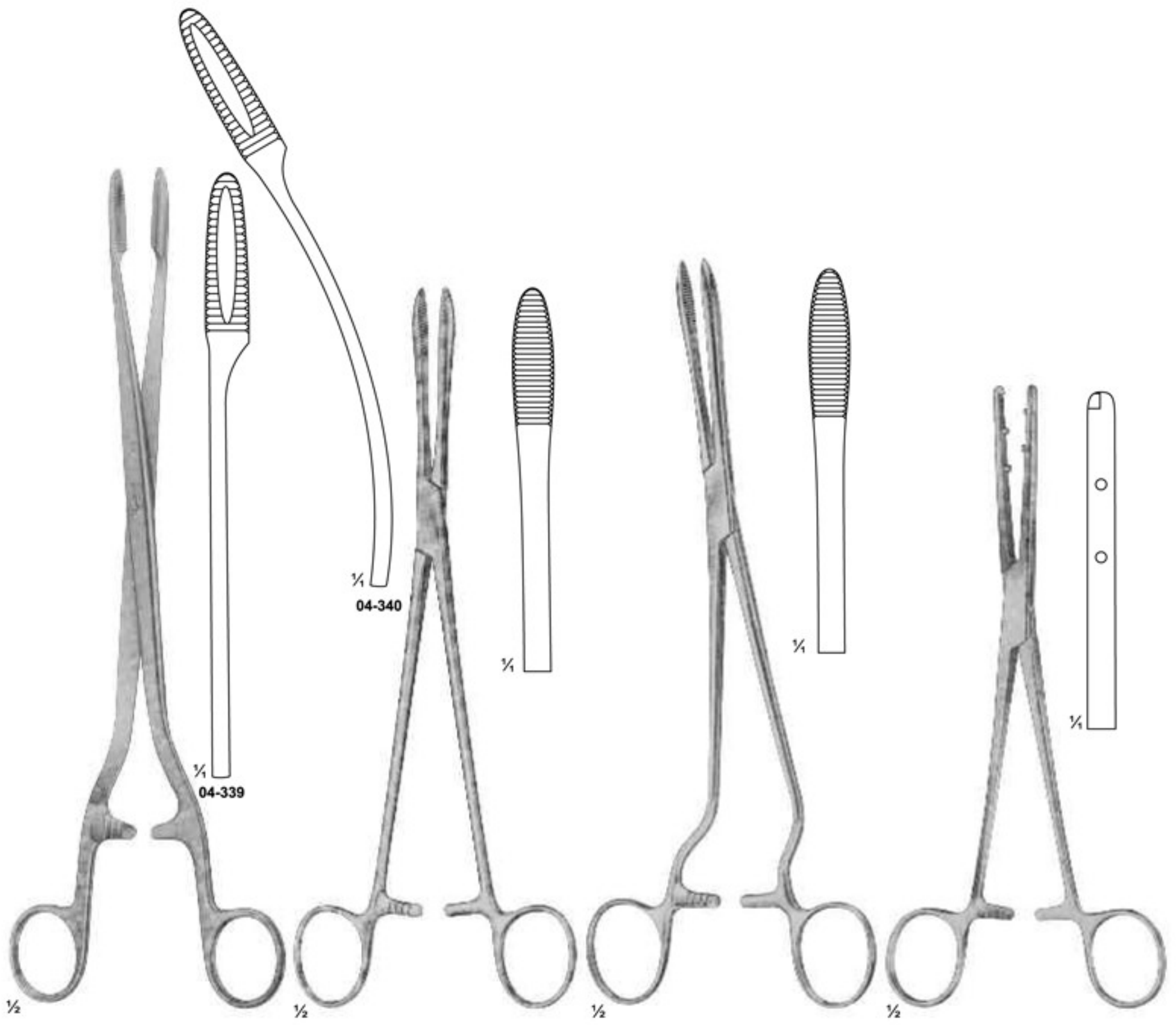

04-339 - 340
SIMS-MAIER
280 mm

04-341
COLLIN
240 mm

04-342
CHERON
Handles Laterally Angled
240 mm

04-343
EMMET
210 mm

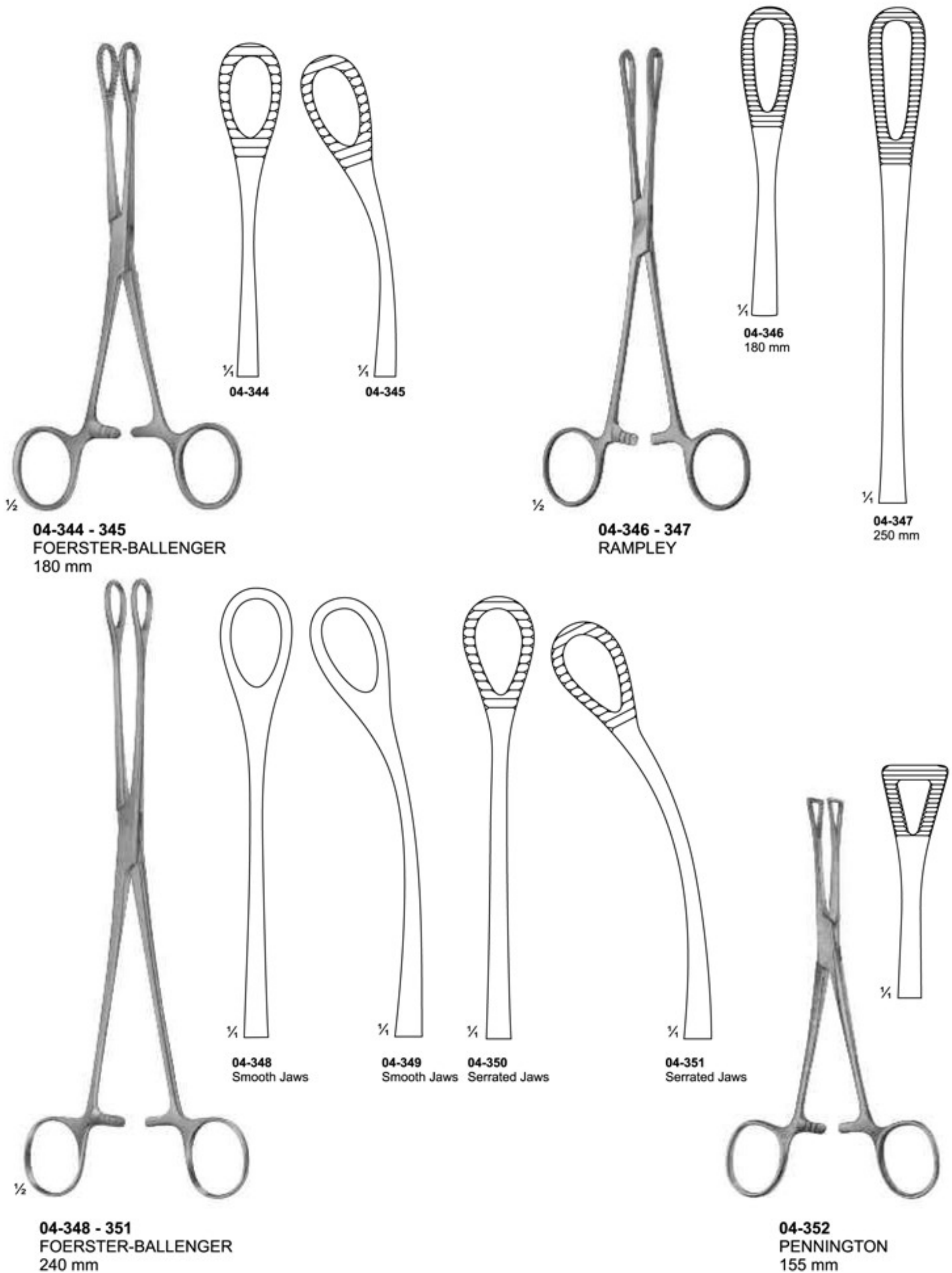

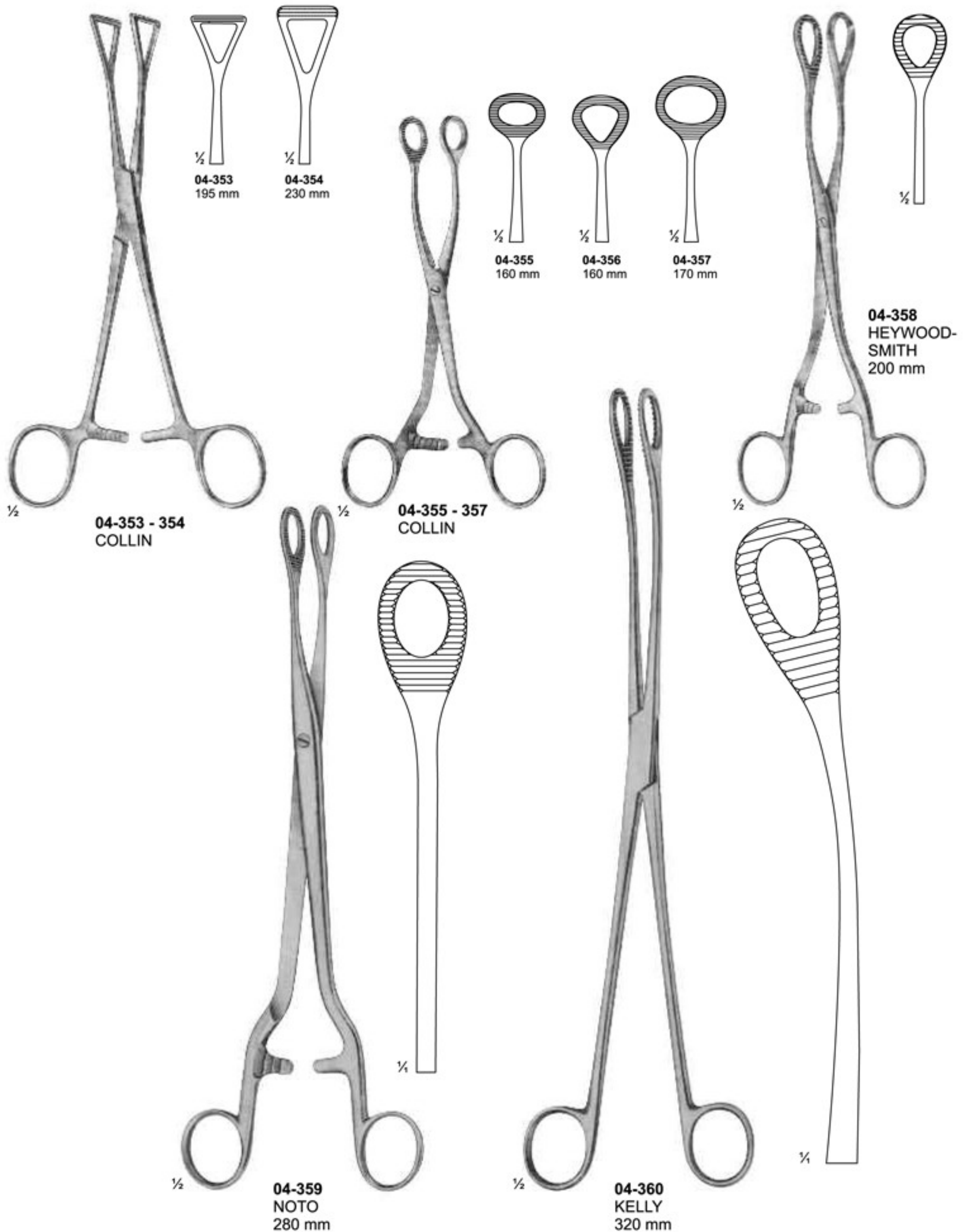

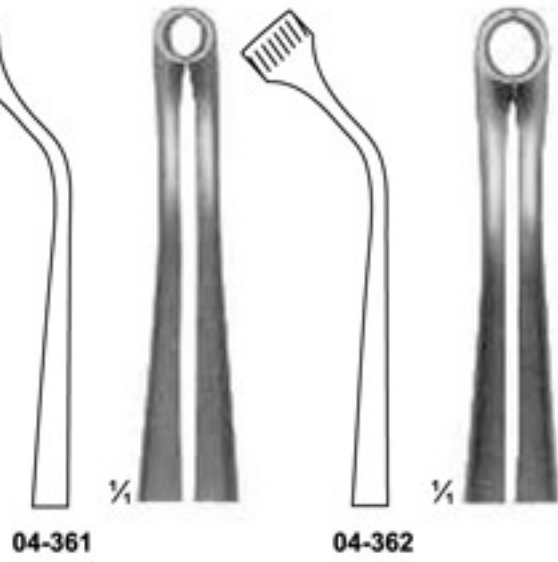

04-361 - 362
HERZ
155 mm



04-363
JACKSON
4 x 5 teeth
150 mm

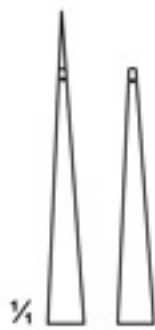
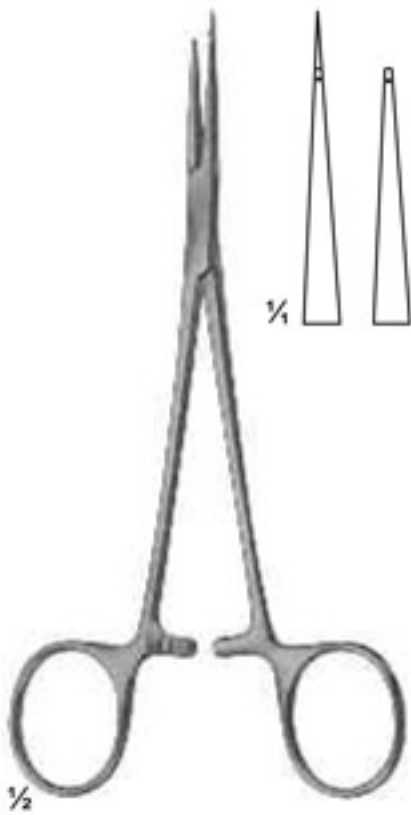

04-364
150 mm

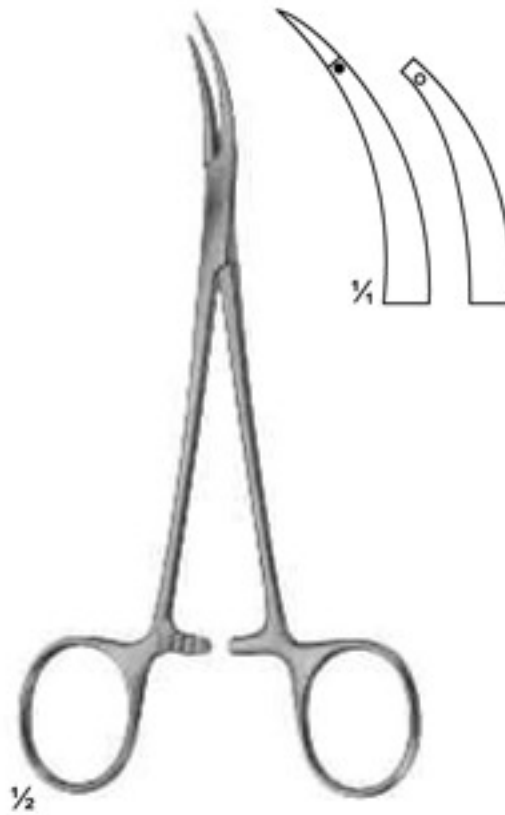

04-365
150 mm

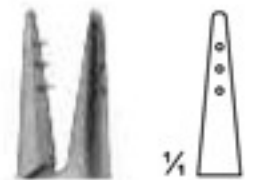

04-366
120 mm

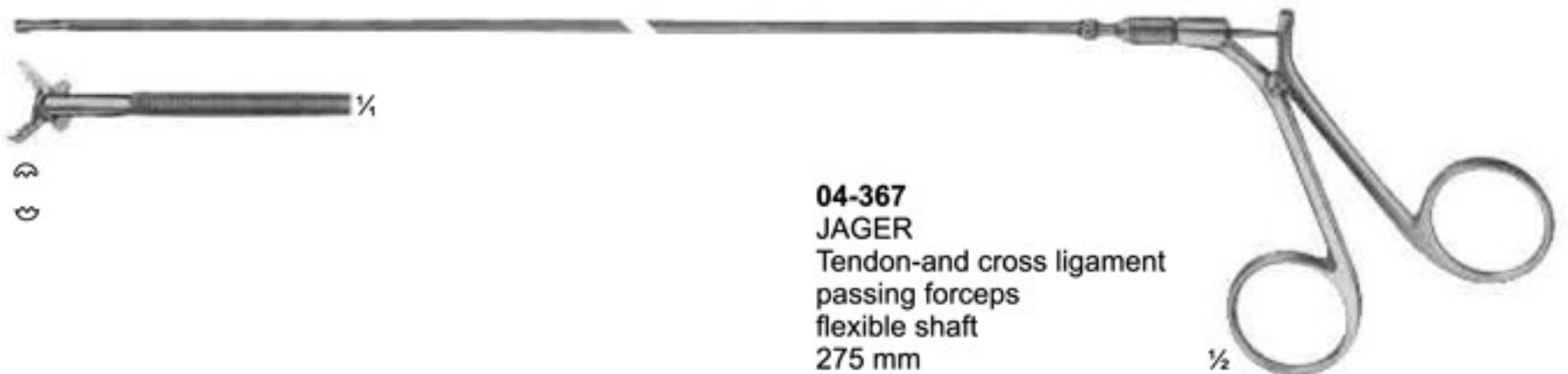

04-367
JAGER
Tendon-and cross ligament
passing forceps
flexible shaft
275 mm

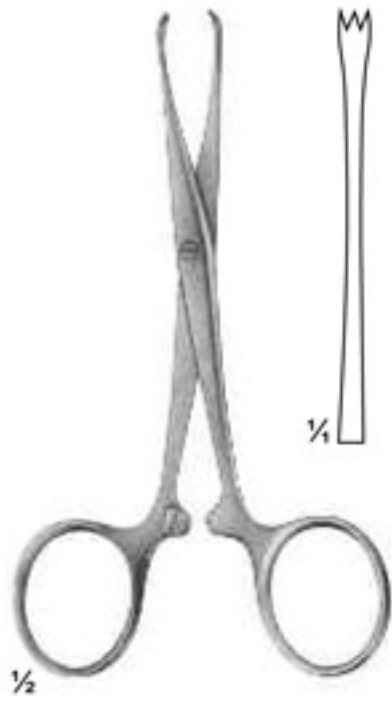

04-368
CHAPUT
 2 x 3 teeth
 125 mm

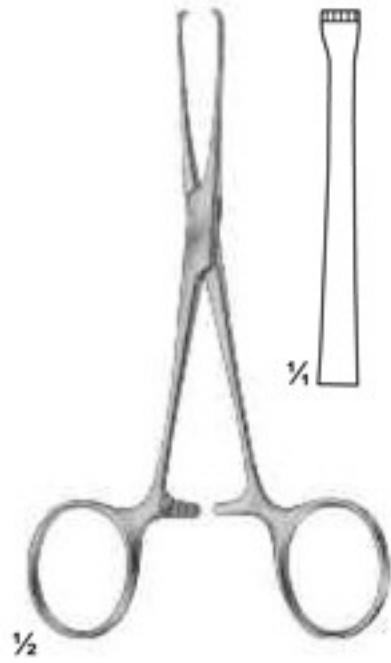

04-369
BABY-ALLIS
 4 x 5 teeth
 130 mm

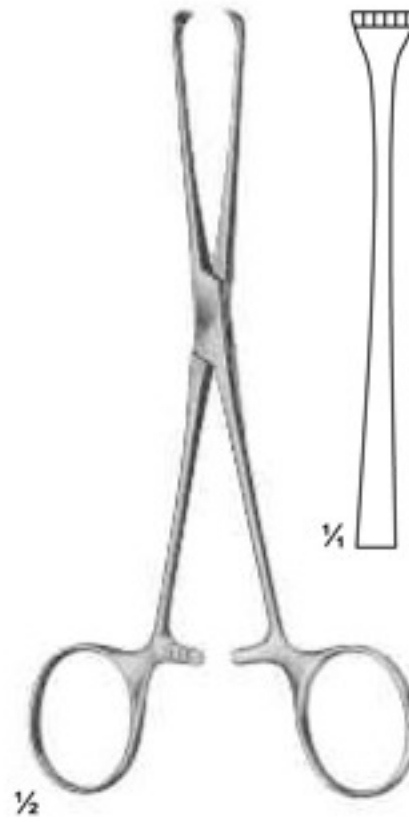

04-370
BOYS-ALLIS
 5 x 6 teeth
 155 mm

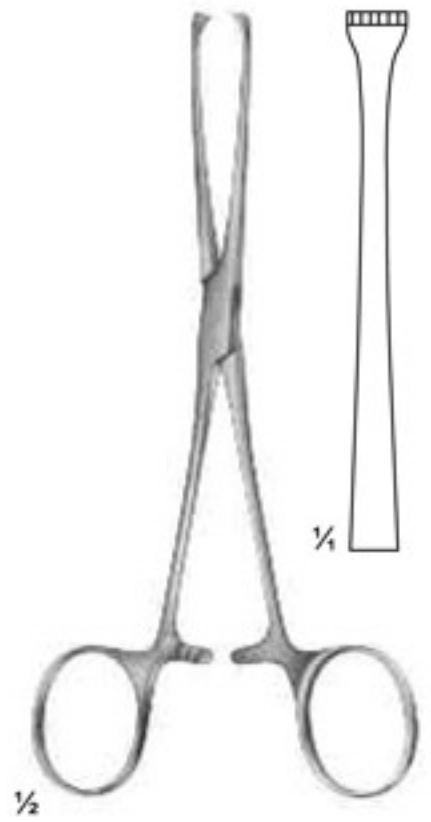

04-371
ALLIS
 5 x 6 teeth
 155 mm



04-372
LAHEY
 135 mm

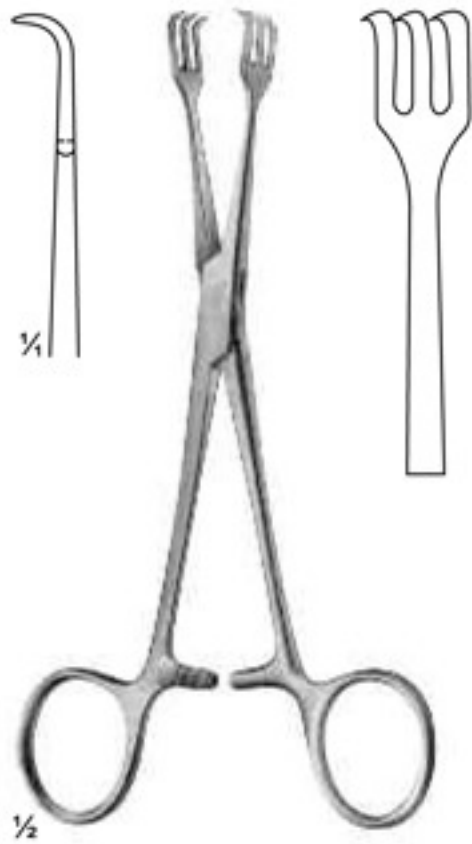

04-373
LAHEY
 135 mm

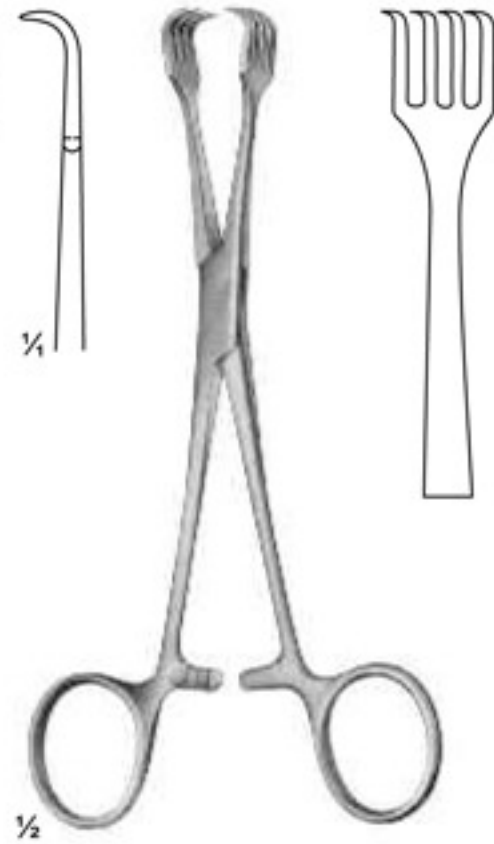

04-374
BRAUN
 155 mm

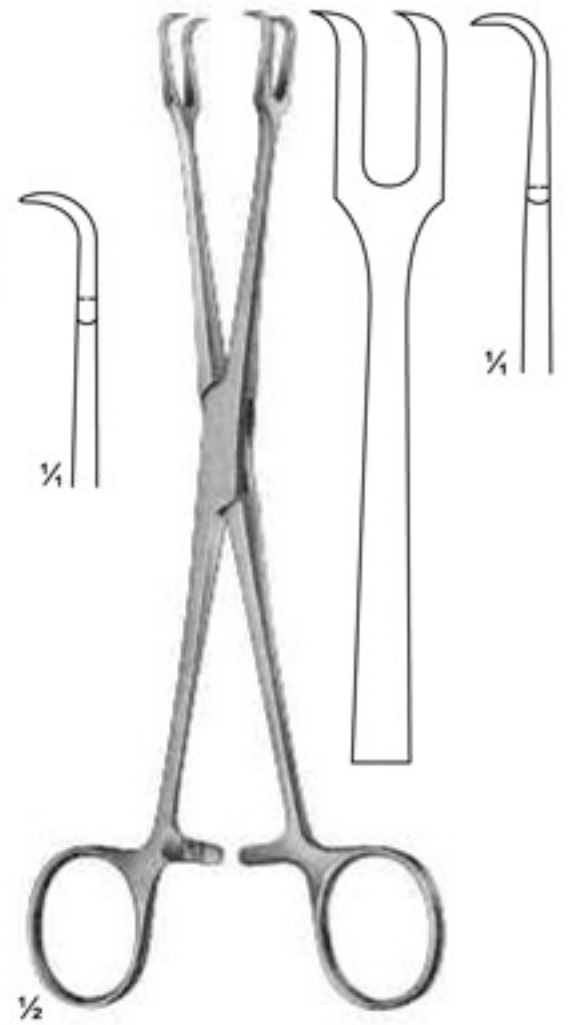

04-375
MUSEUX
 200 mm

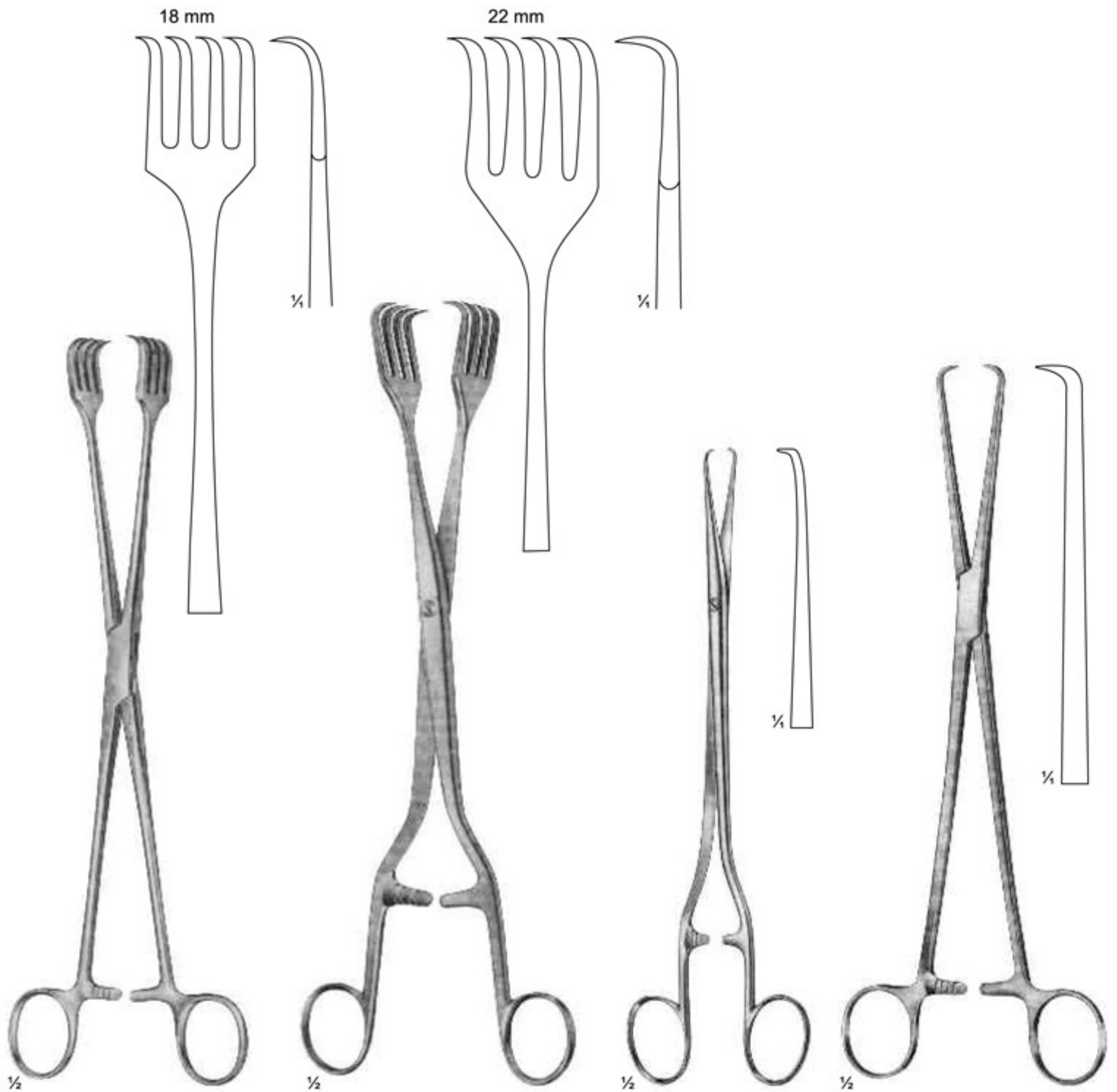

04-376
AESCULAP
260 mm

04-377
PRATT
270 mm

04-378
TIEMANN
Bullet forceps
220 mm

04-379
SCHRODER
250 mm

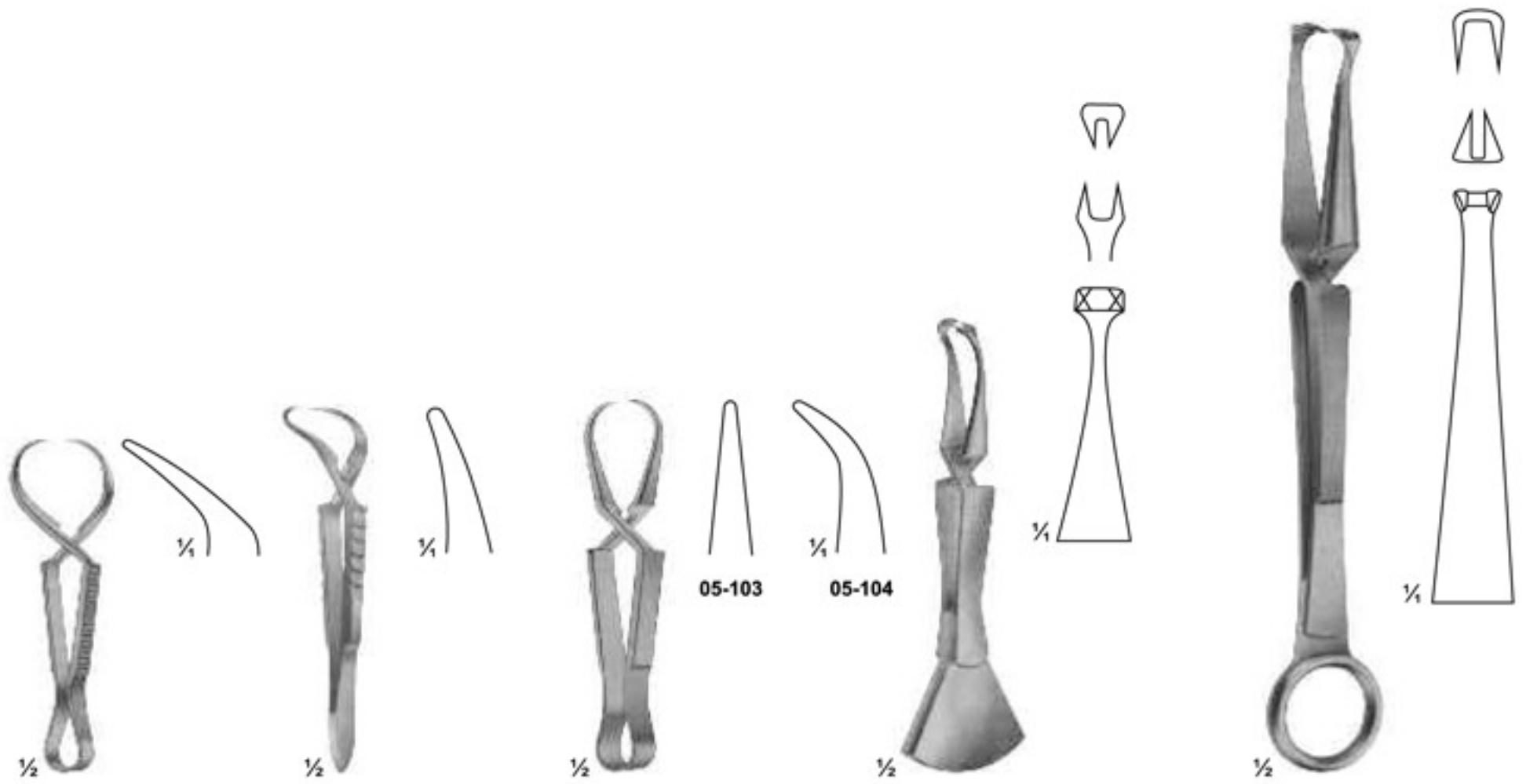

05-101
JONES
85 mm

05-102
ENGL. MOD.
85 mm

05-103 - 104
SCHAEDEL
85 mm

05-105
DOYEN
110 mm

05-106
DOYEN
180 mm

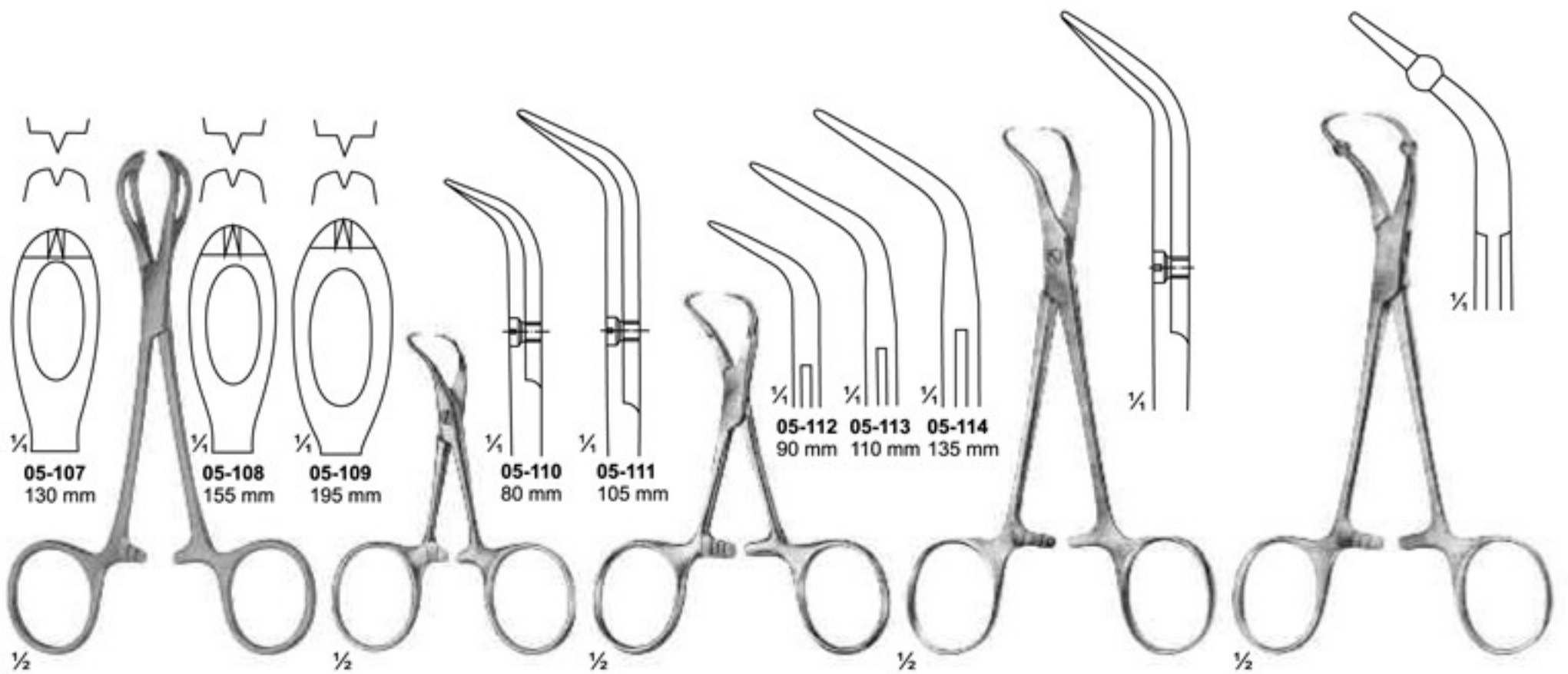

05-107
130 mm

05-108
155 mm

05-109
195 mm

05-110
80 mm

05-111
105 mm

05-112 05-113 05-114
90 mm 110 mm 135 mm

05-107 - 109
LANE

05-110 - 111
BACKHAUS

05-112 - 114
BACKHAUS

05-115
BACKHAUS-KOCHER
135 mm

05-116
ROEDER
135 mm

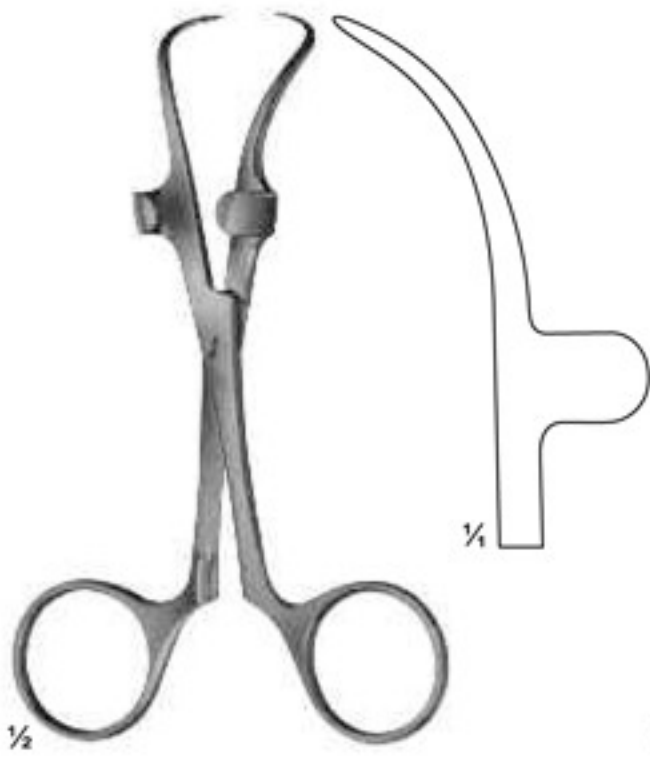

05-117
ROBIN
 with holders for tubing
 up to 13 mm
 135 mm



05-118
 with clip for tubing
 up to 15 mm
 110 mm

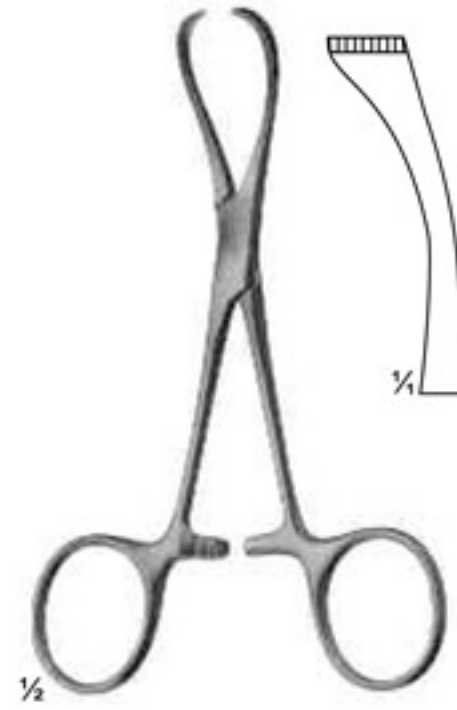

05-119
LORNA
 non perforating
 130 mm



05-120
 for paper cloths
 140 mm



05-121
BUNT
 105 mm



05-122
MAYO
 140 mm

Closing force

05-123 Straight 80g 50g
05-124 Curved 80g 50g
05-125 Curved tips 80g 50g
05-126 Angled Shaped 80g 50g
05-127 Muller Knee-bent 80g 50g
05-128 Muller Ligature Forceps

05-129 35 mm
05-130 35 mm
05-131 45 mm
05-132 45 mm
05-133 DIEFFENBACH 38 mm
05-134 48 mm
05-135 DIEFFENBACH 38 mm
05-136 48 mm
05-137 DIEFFENBACH 58 mm
05-138 DIEFFENBACH 58 mm
05-139 - 145 JOHNS-HOPKINS 38 mm, 48 mm, 56 mm, 63 mm, 70 mm, 80 mm, 90 mm
05-146 DE BAKEY-HESS 20 mm

05-147 DE BAKEY Length 50 mm Jaws 27 mm
05-148 DE BAKEY Length 48 mm Jaws 27 mm
05-149 GLOVER Length 57 mm Jaws 35 mm
05-150 DE BAKEY Length 73 mm Jaws 38 mm
05-151 DE BAKEY Length 99 mm Jaws 63 mm
05-152 DE BAKEY Length 95 mm Jaws 54 mm
05-153 DE BAKEY L. 80 mm
05-154 L. 90 mm
05-155 L. 105 mm
05-156 L. 124 mm
05-157 DE BAKEY L. 78 mm
05-158 L. 86 mm
05-159 L. 97 mm
05-160 L. 114 mm
05-161 GLOVER L. 68 mm
05-162 L. 96 mm
05-163 L. 117 mm
05-164 GLOVER L. 65 mm
05-165 L. 91 mm
05-166 L. 110 mm

Jaw, cross serrated



06-101
CARREL
85 mm



06-102 - 105
BABY-MOSQUITO
(HARTMANN)
100 mm

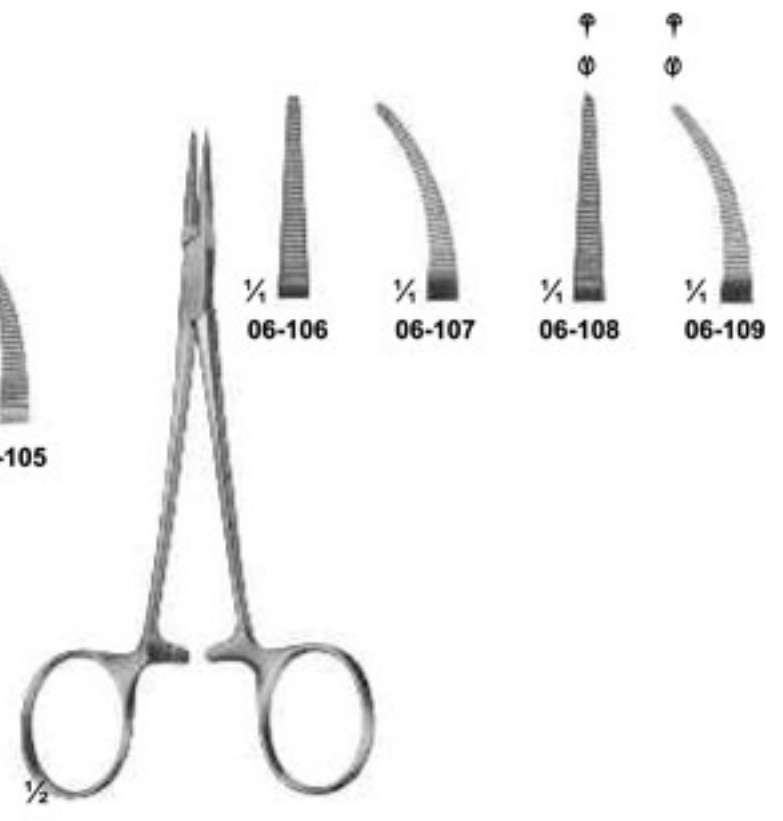

06-106 - 109
MICRO-HALSTED
125 mm



06-110 - 113
HALSTED-MOSQUITO
125 mm

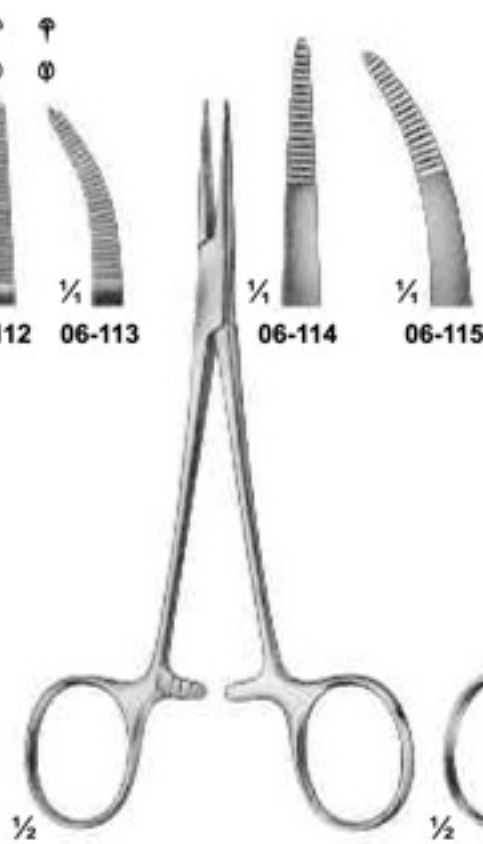

06-114 - 115
PROVIDENCE-HOSPITAL
140 mm

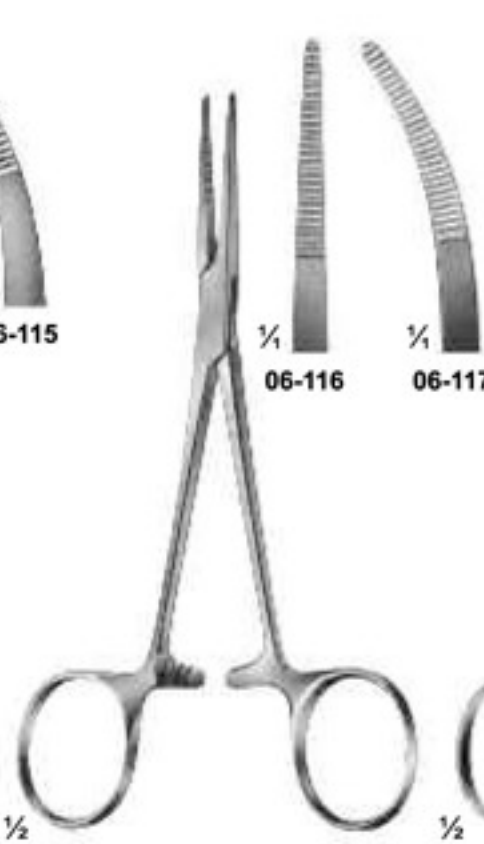

06-116 - 117
KELLY
140 mm

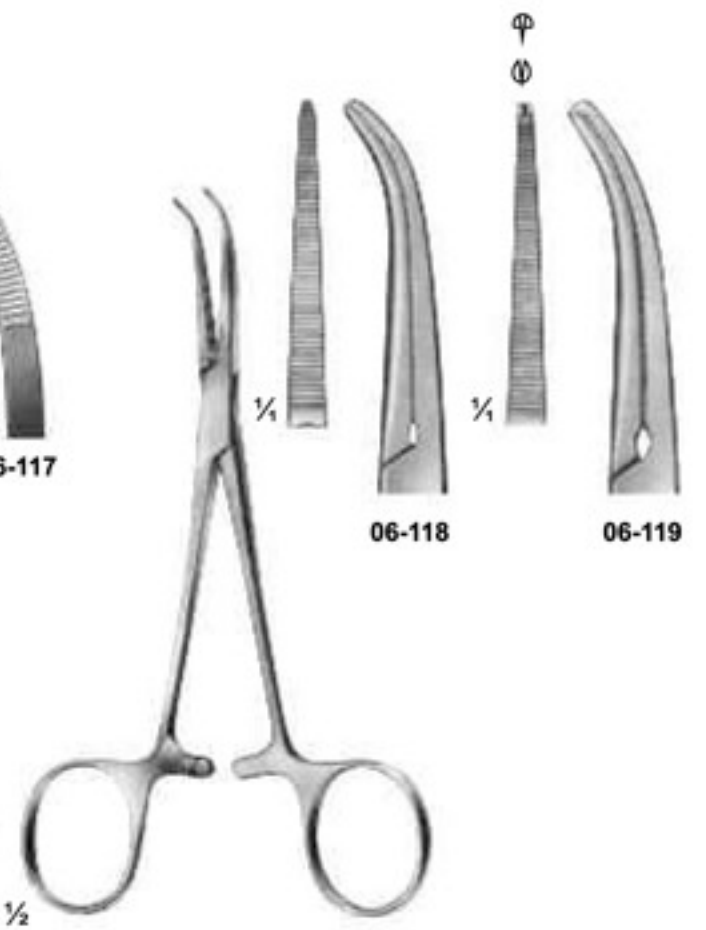

06-118 - 119
DANDY
Curved sideways
140 mm

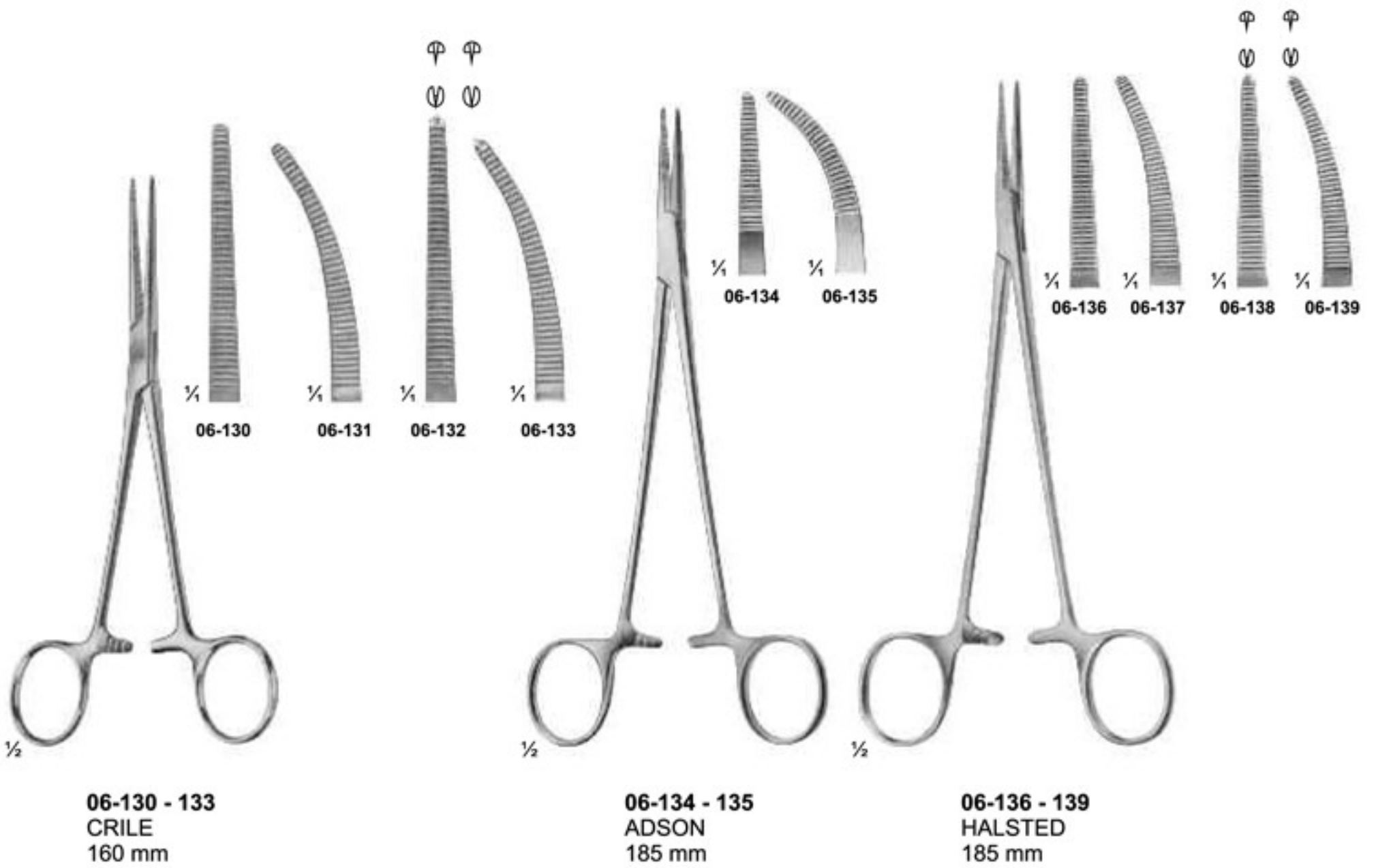
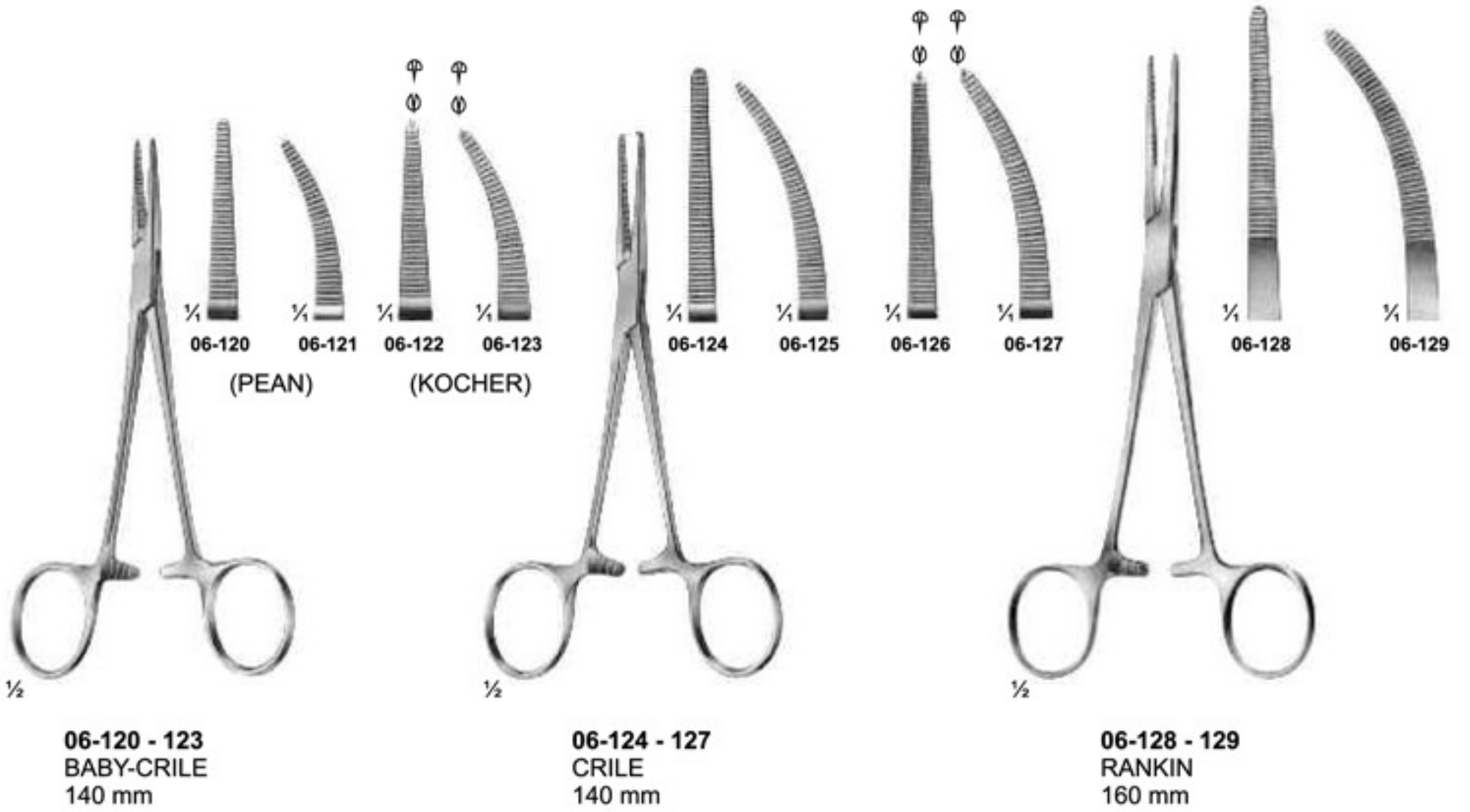

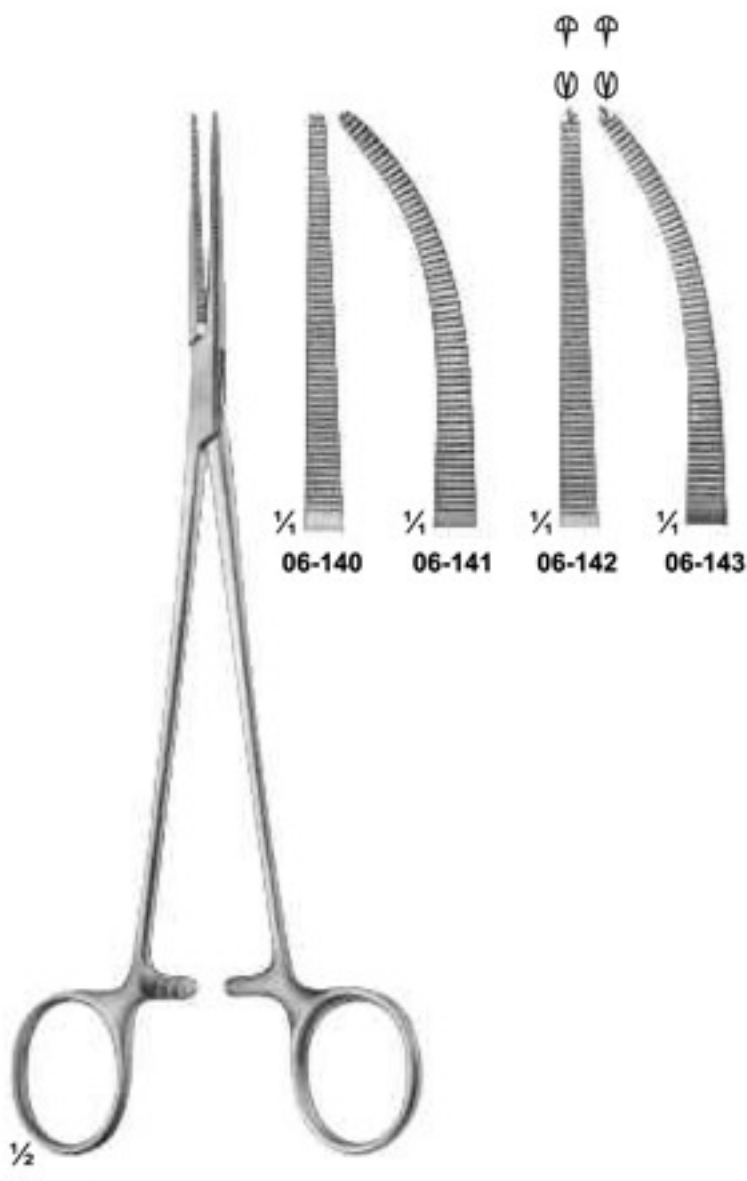

06-140 - 143
HALSTED-MOSQUITO
200 mm



06-144 - 148
HEISS
200 mm



06-149 - 150
HALSTED
215 mm

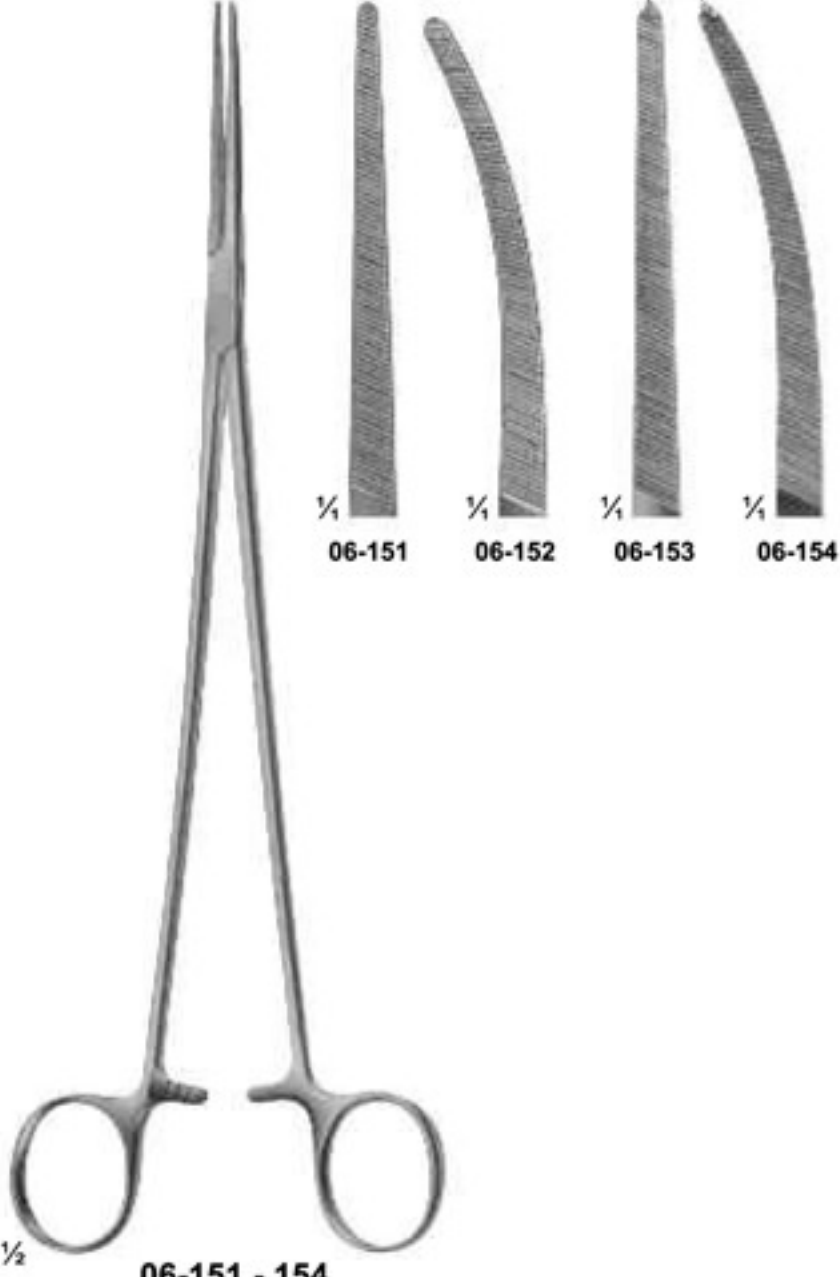

06-151 - 154
BENGOLEA
245 mm

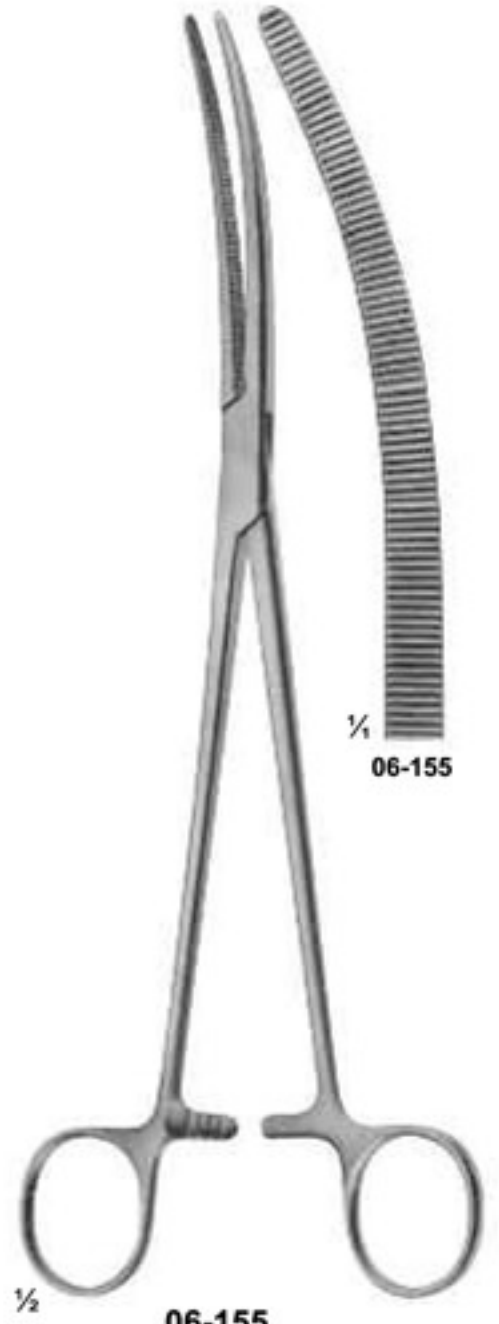

06-155
CRAFOORD
245 mm

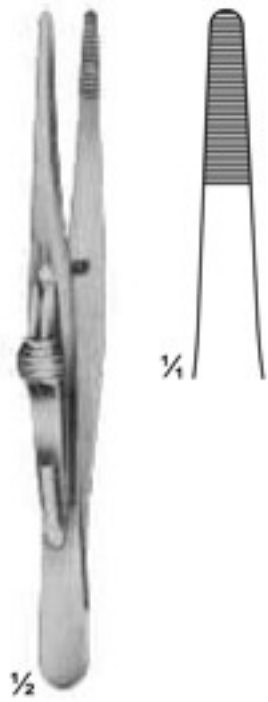

06-156
FRICKE
Artery forceps
130 mm



06-157
KRONLEIN
130 mm

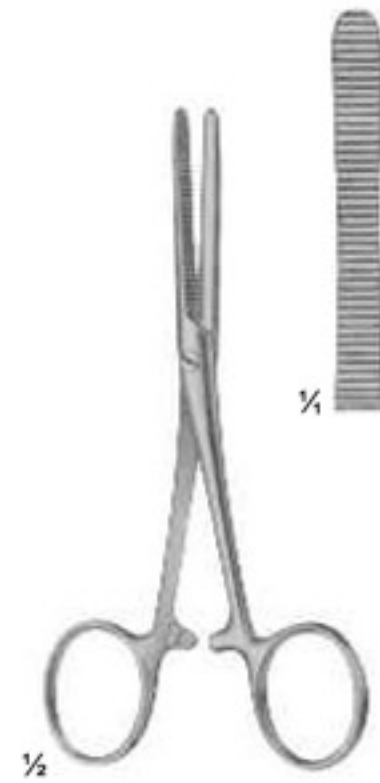

06-158
PEAN
125 mm

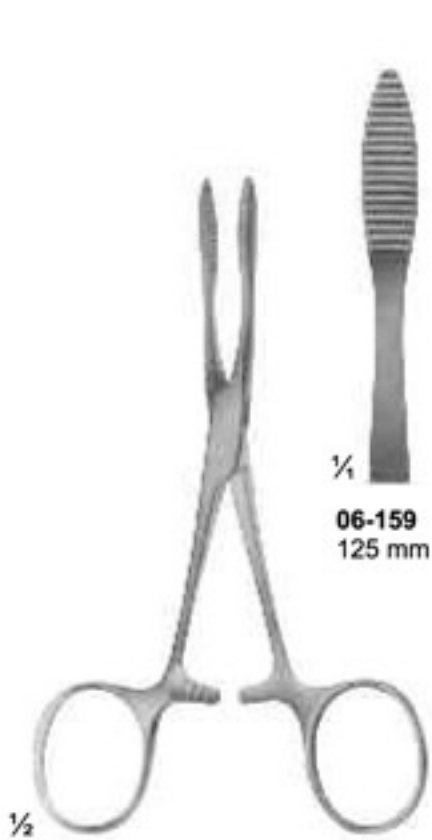

06-159 - 160
PEAN



06-160
140 mm

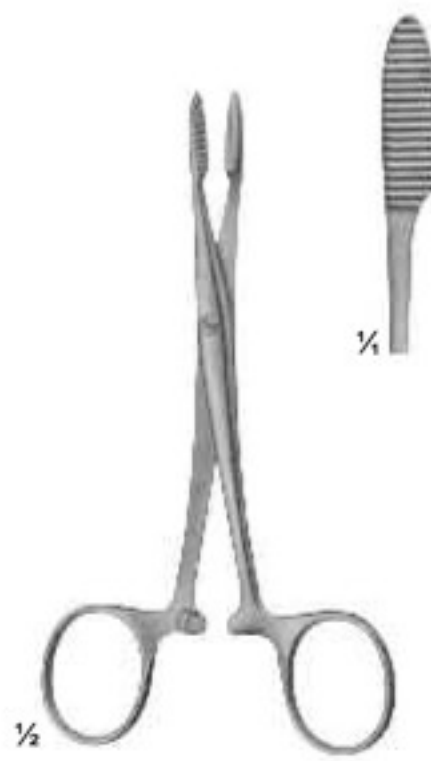

06-161
PEAN

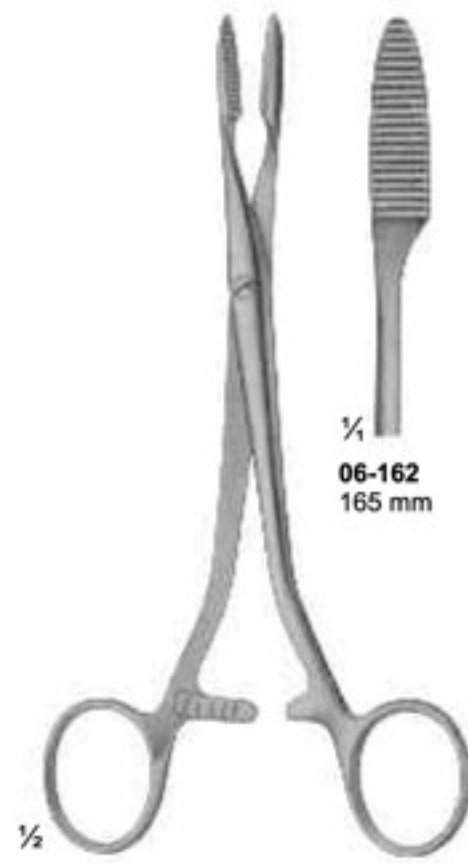

06-162 - 163
PEAN



06-162
165 mm



06-163
185 mm

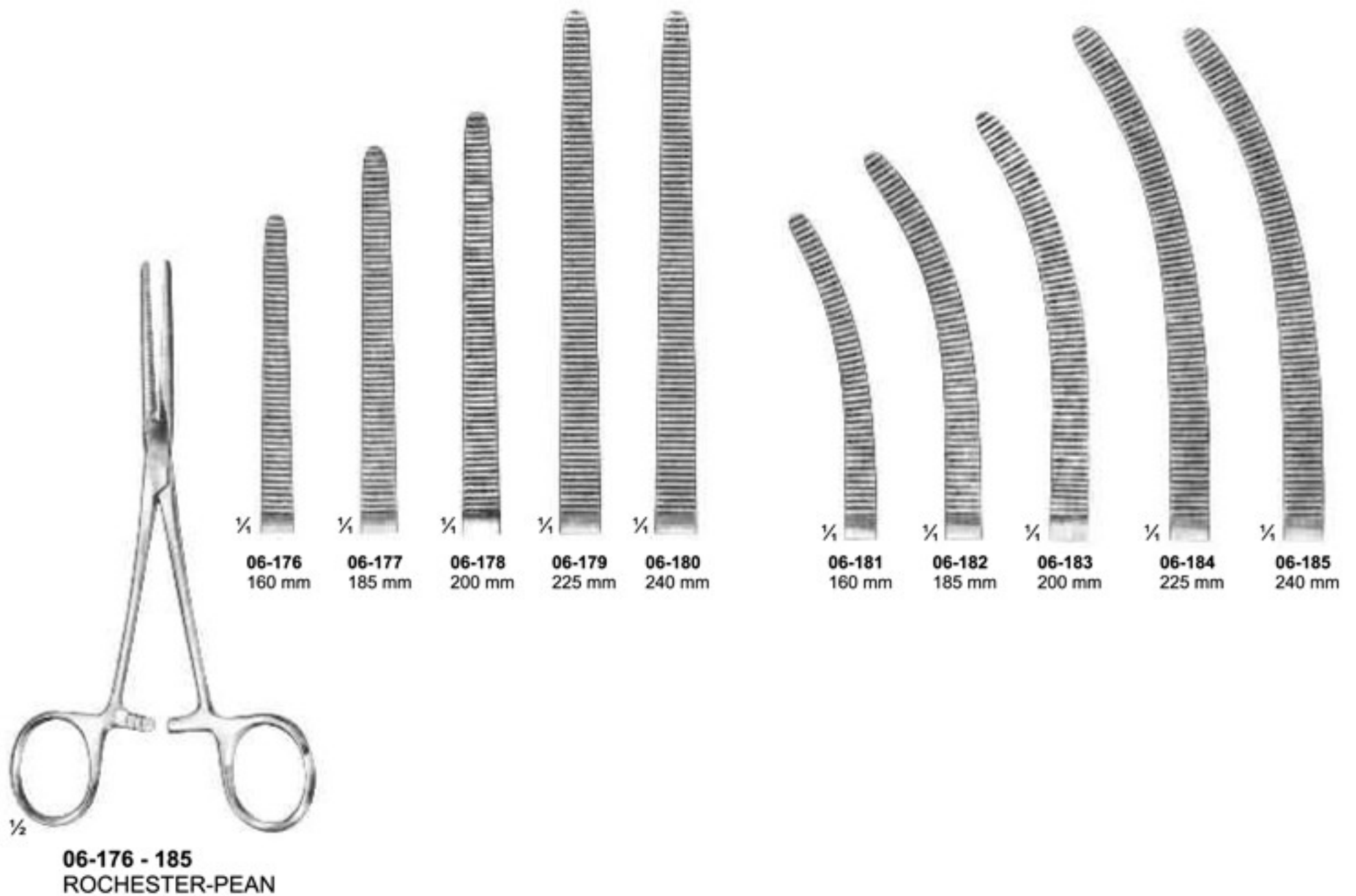
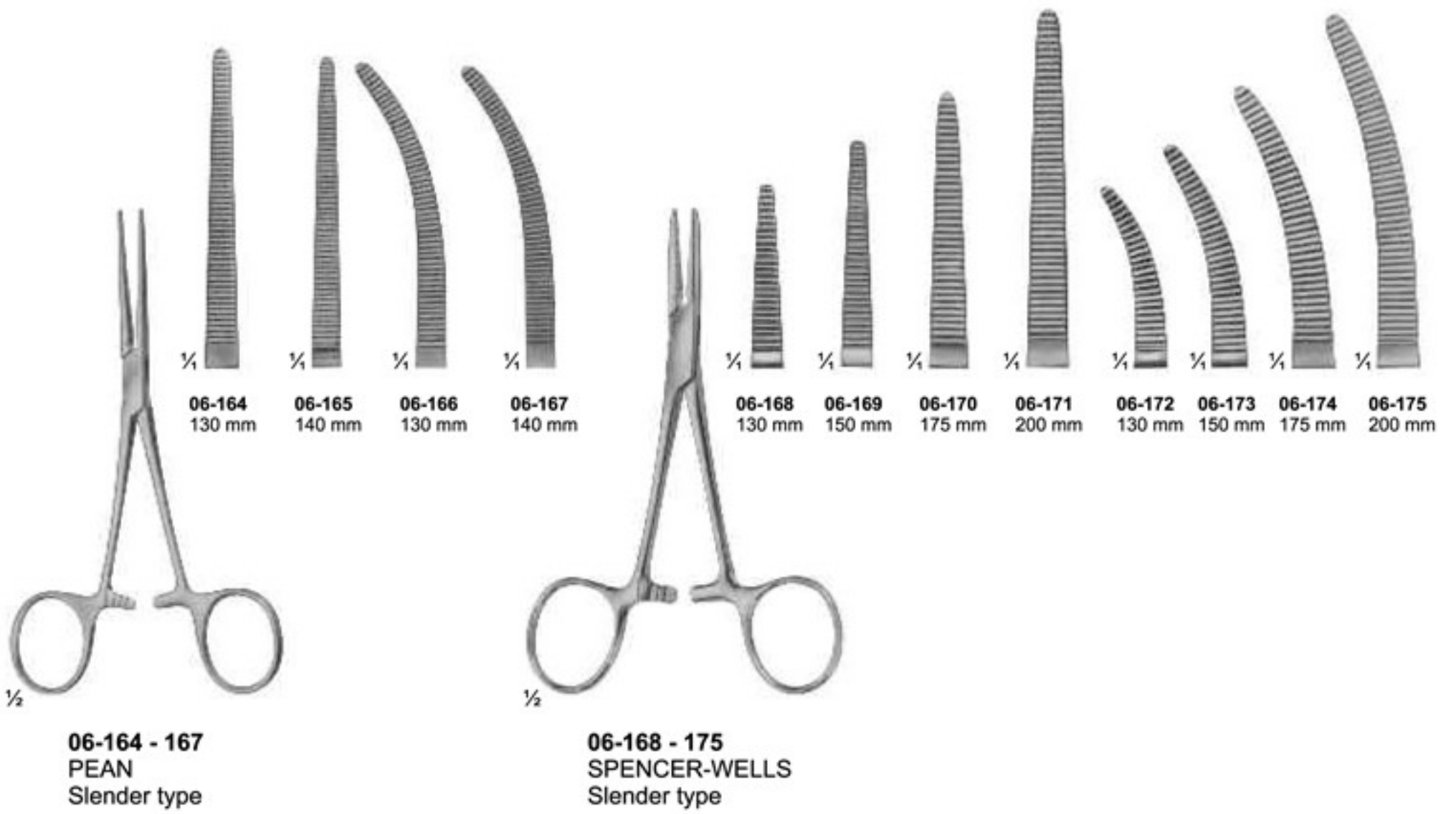

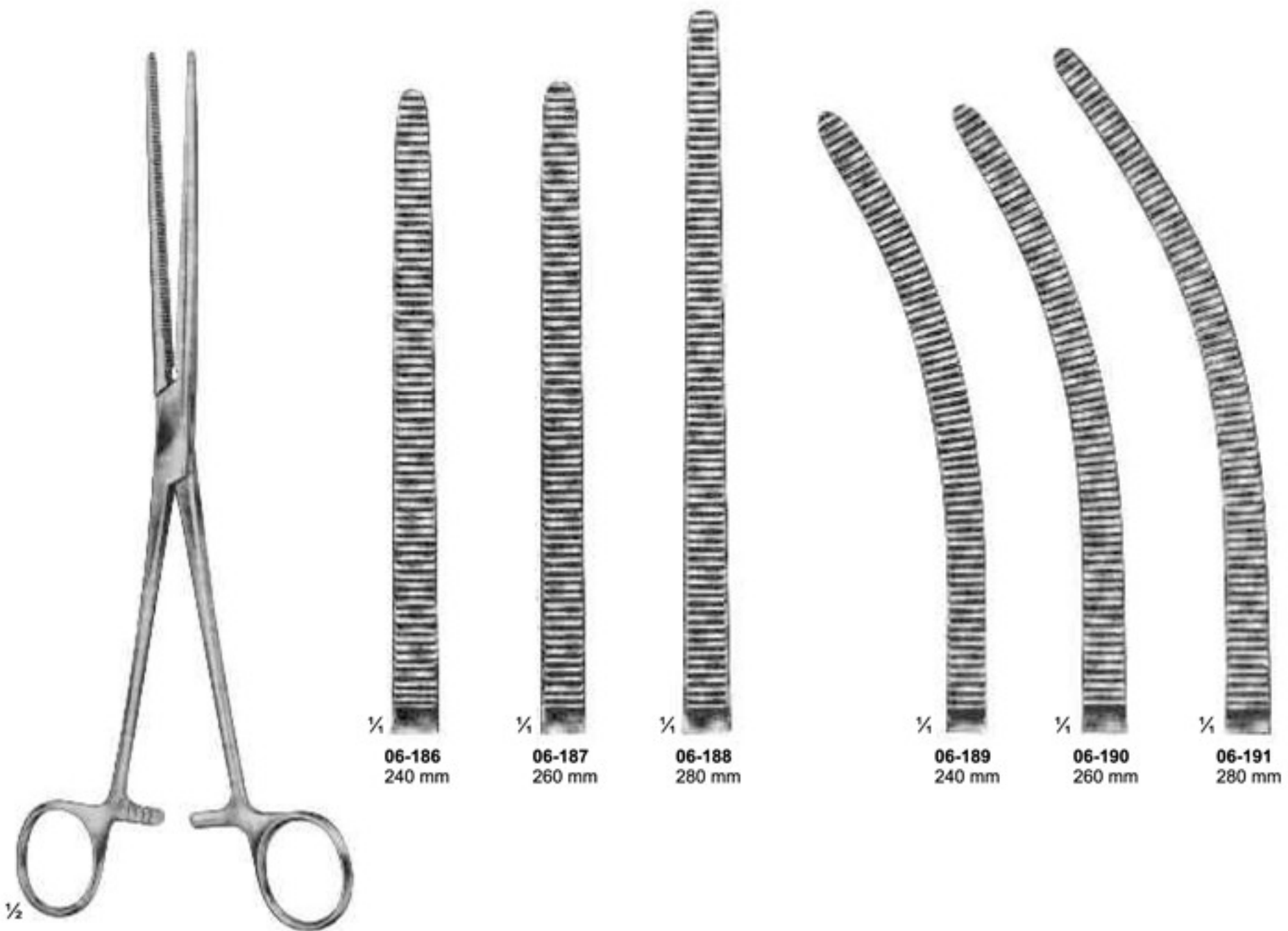

06-186 - 191
PEAN

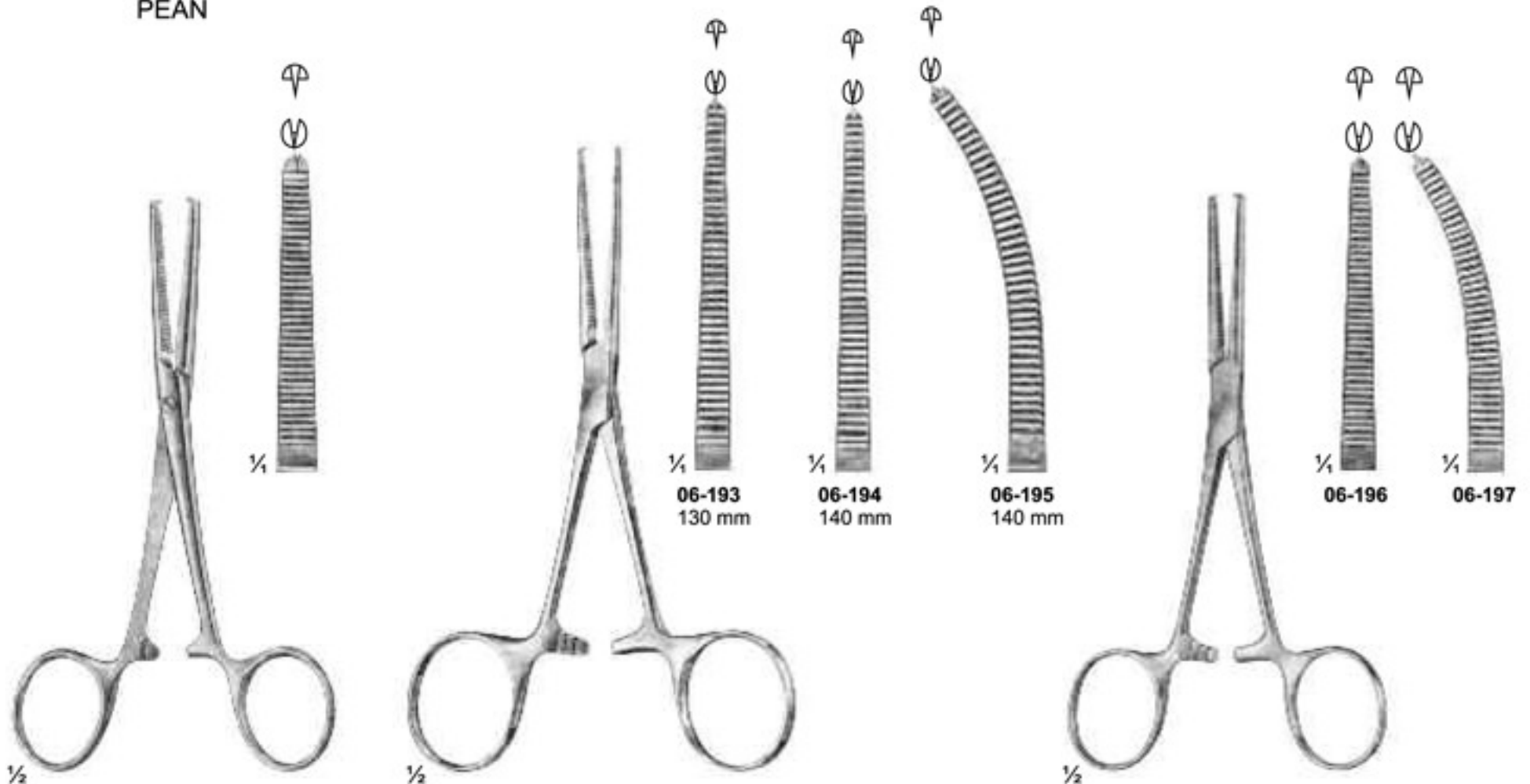

06-192
KOCHER
Strong Pattern
145 mm

06-193 - 195
KOCHER

06-196 - 197
ROCHESTER-OCHSNER
140 mm

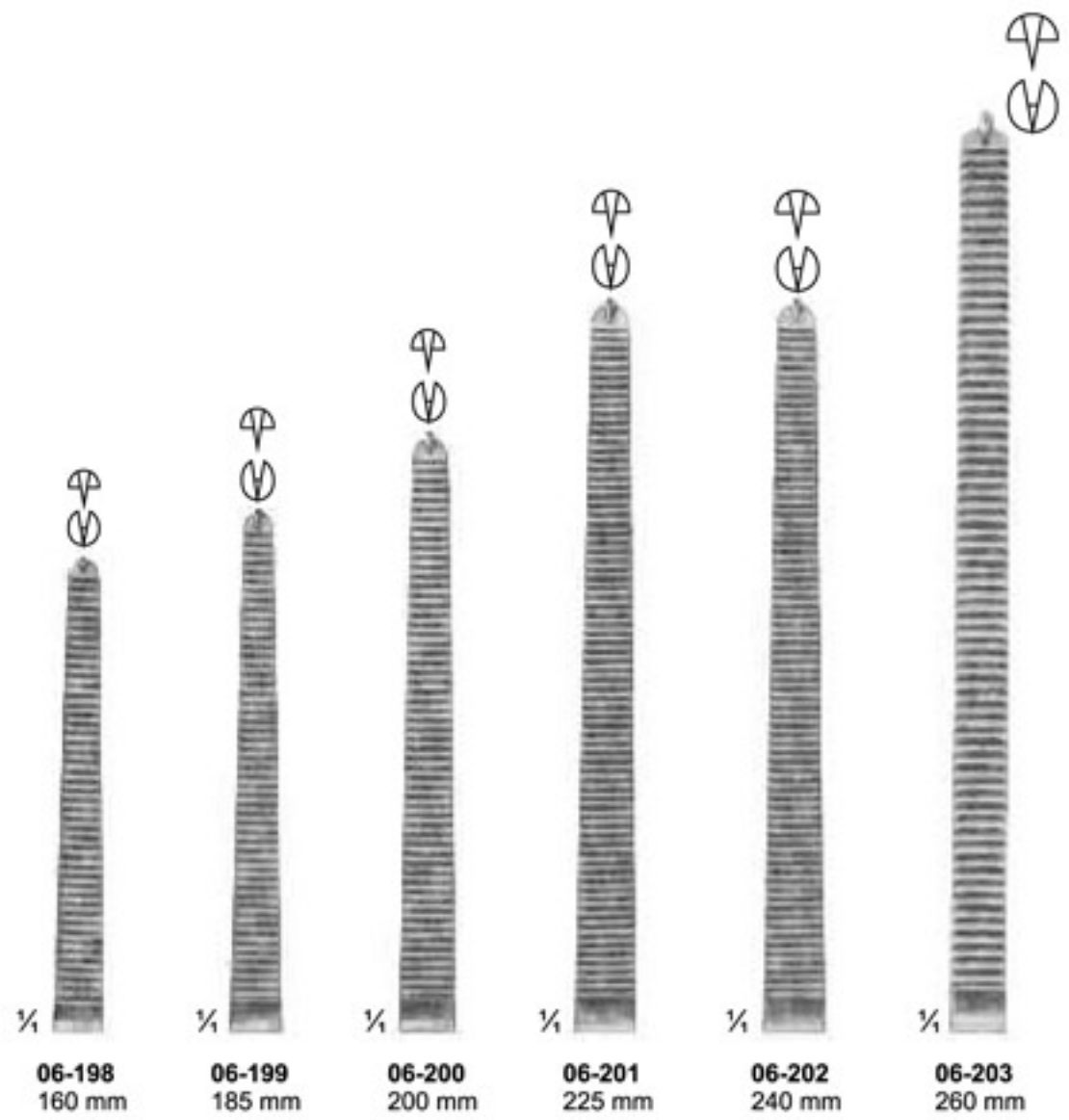

06-198 - 209
KOCHER-OCHSNER

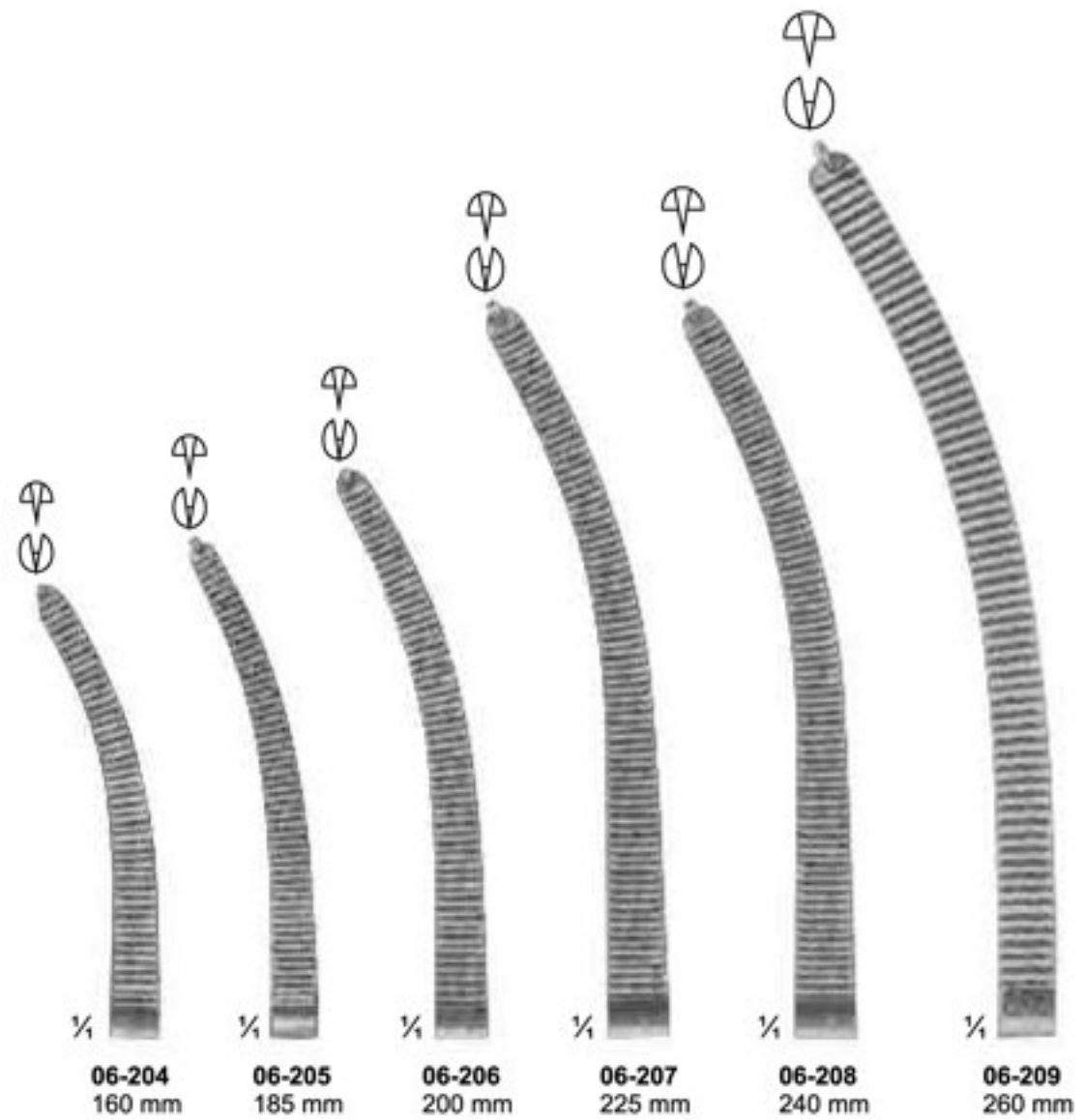

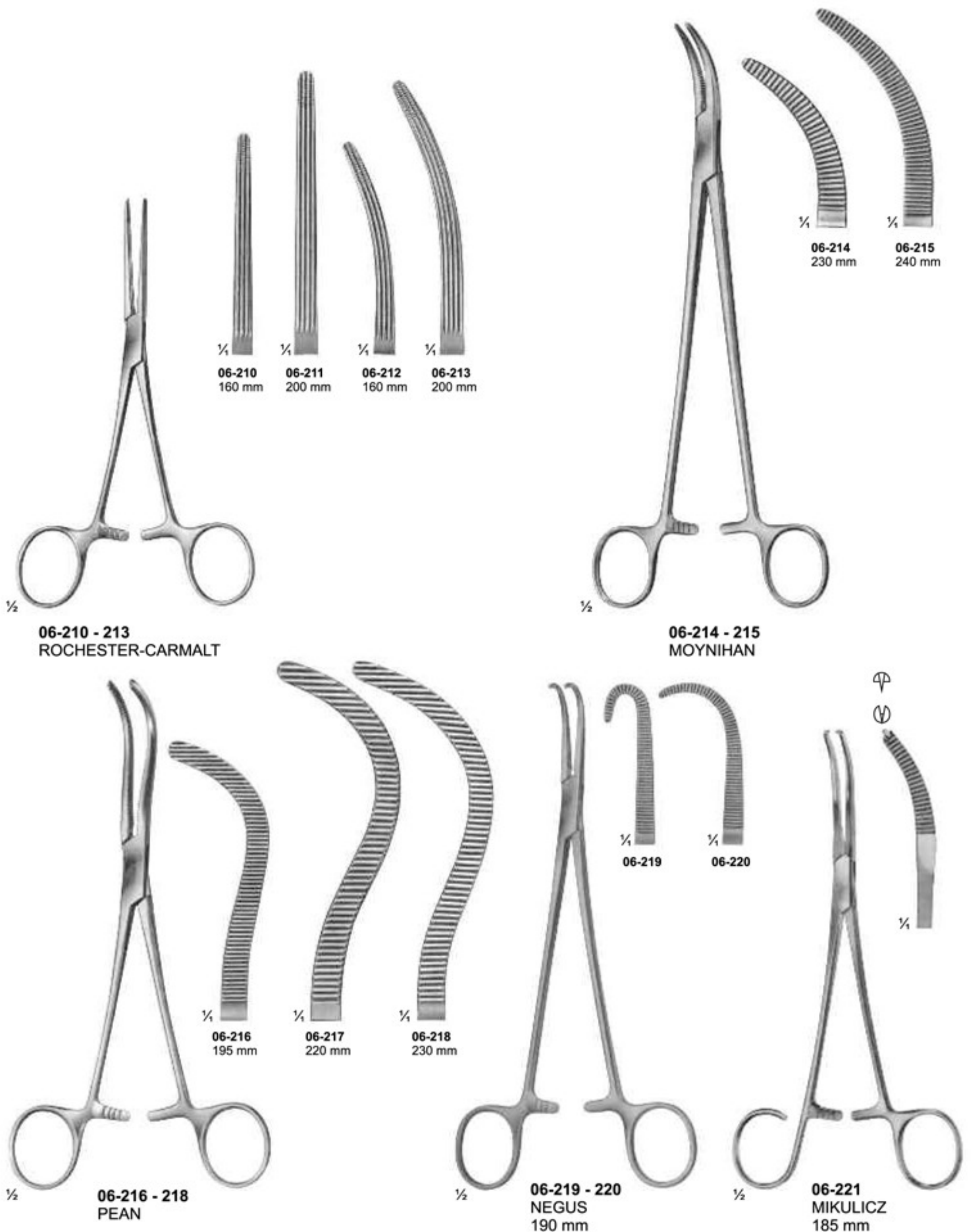



06-222
MICRO-ADSON
140 mm



06-223
BABY-OVERHOLT
135 mm



06-224 - 225
BABY-MIXTER

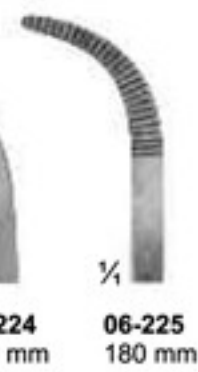

06-226 - 227
BABY-ADSON

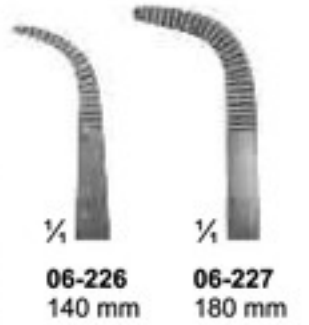

06-228
NISSSEN



06-229 - 230
YASARGIL
195 mm



06-231
OVERHOLT-MIXTER



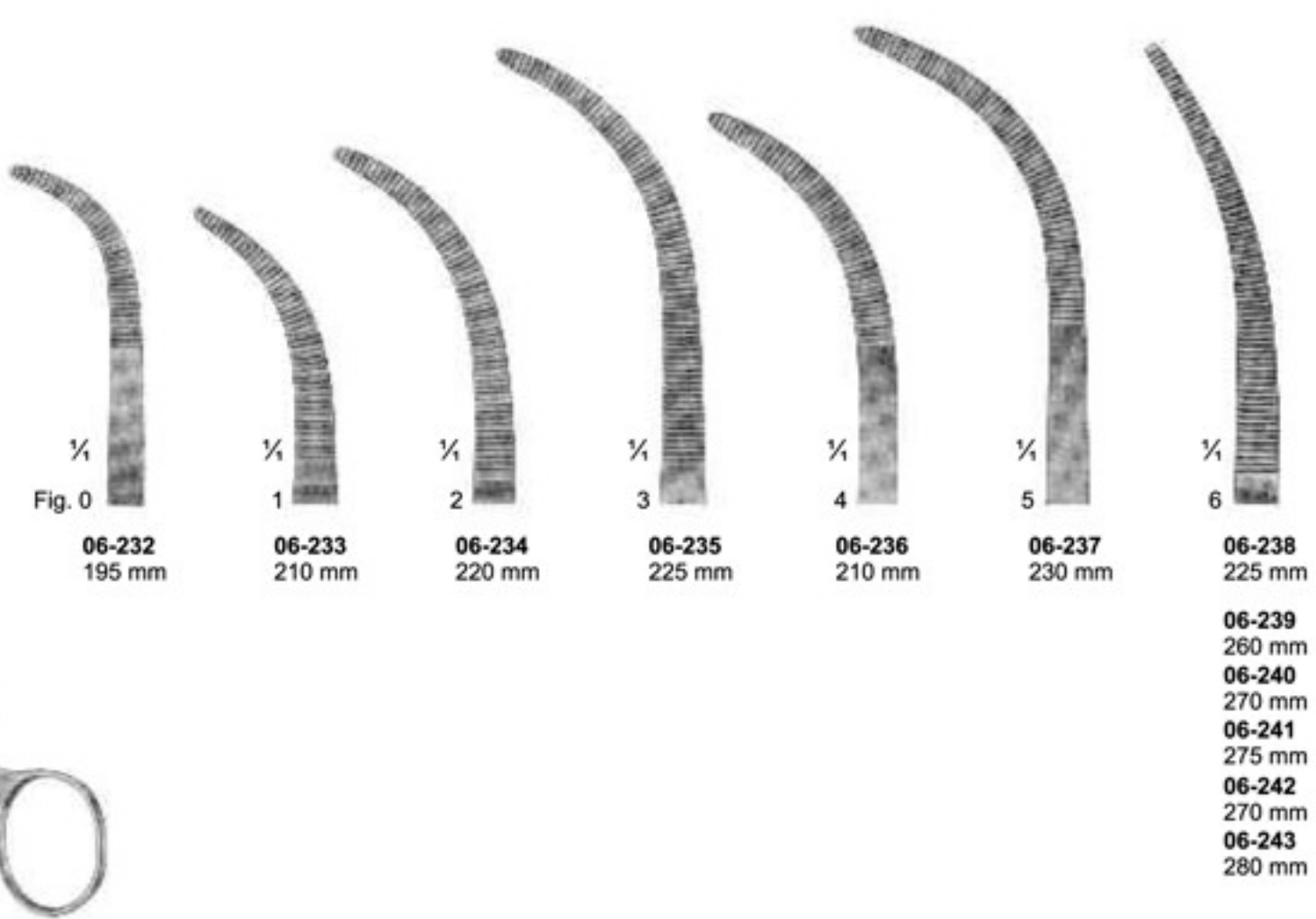
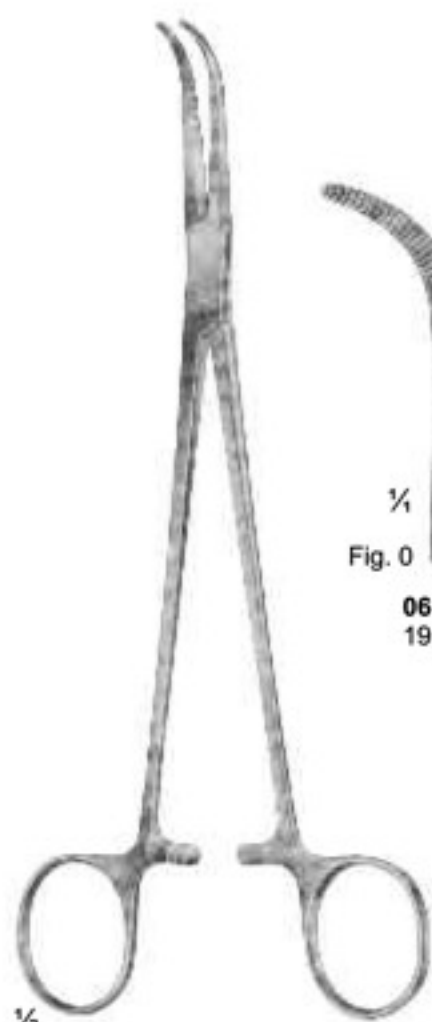

Fig. 0	1	2	3	4	5	6
06-232 195 mm	06-233 210 mm	06-234 220 mm	06-235 225 mm	06-236 210 mm	06-237 230 mm	06-238 225 mm
						06-239 260 mm
						06-240 270 mm
						06-241 275 mm
						06-242 270 mm
						06-243 280 mm

06-232 - 243
OVERHOLT-GEISSENDOERFER

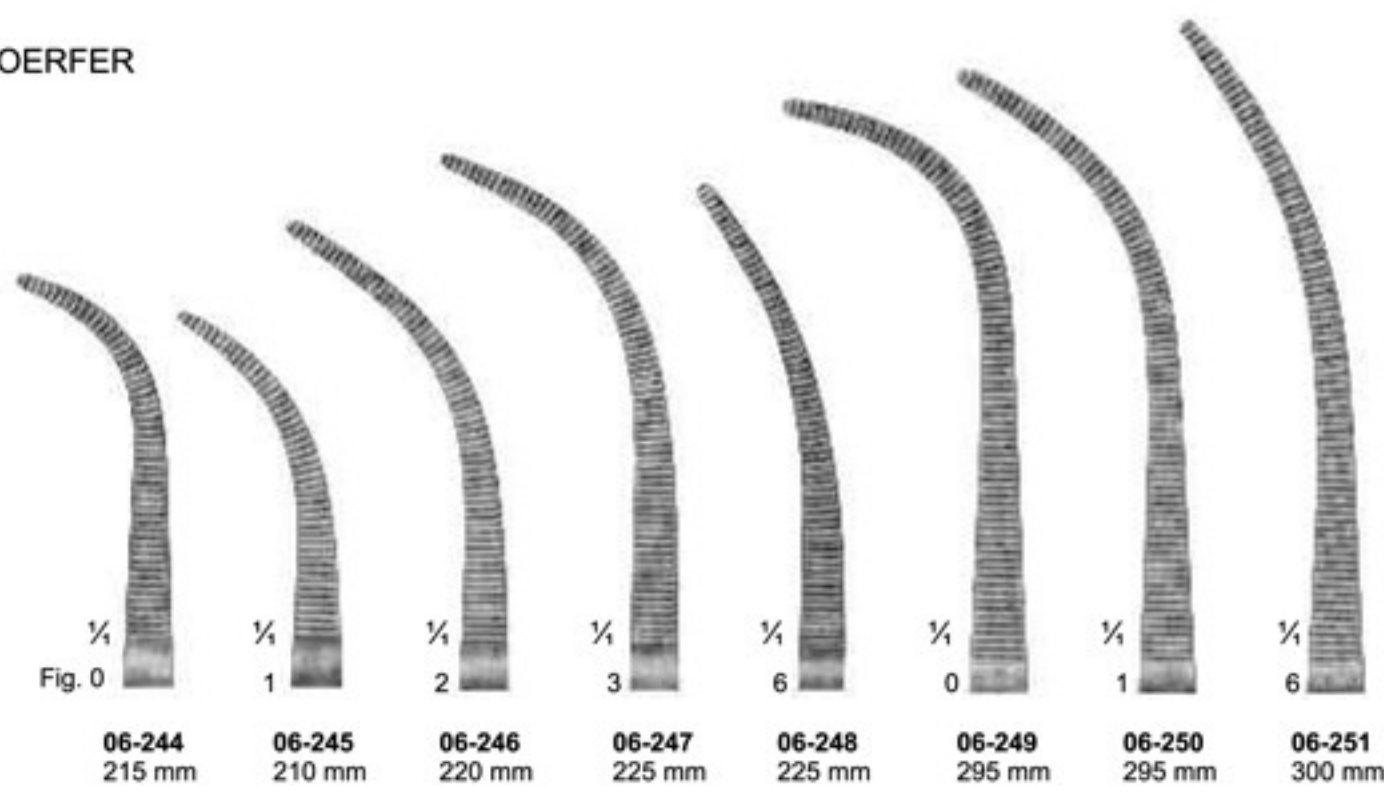

Fig. 0	1	2	3	6	0	1	6
06-244 215 mm	06-245 210 mm	06-246 220 mm	06-247 225 mm	06-248 225 mm	06-249 295 mm	06-250 295 mm	06-251 300 mm

06-244 - 251
OVERHOLT
fine pattern



$\frac{1}{2}$
06-252
 MIXTER-O'SHAUGHNESSY
 190 mm



$\frac{1}{2}$
06-253
 HEISS
 195 mm

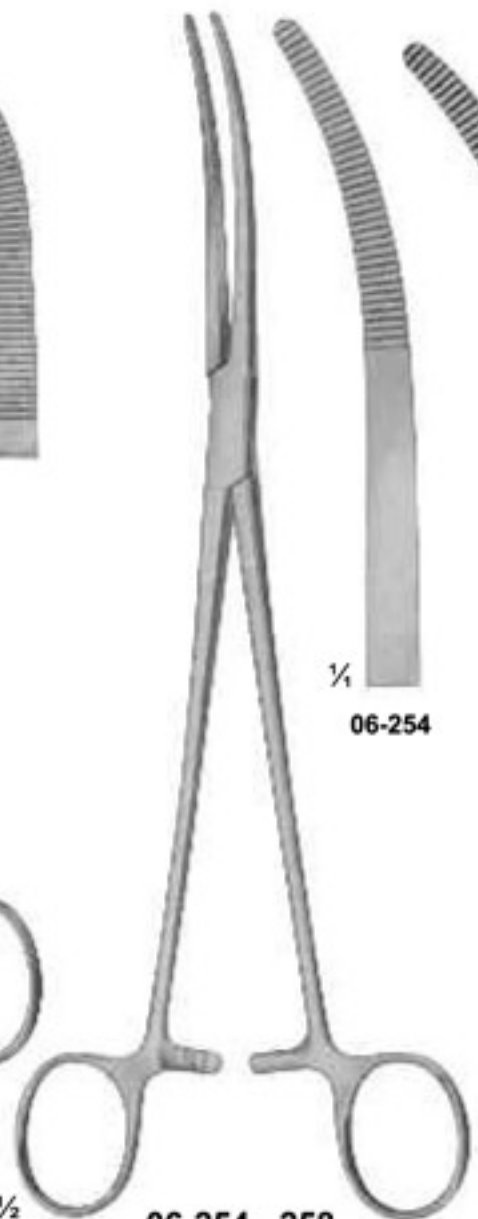

$\frac{1}{2}$
06-254 - 258
 RUMEL
 240 mm

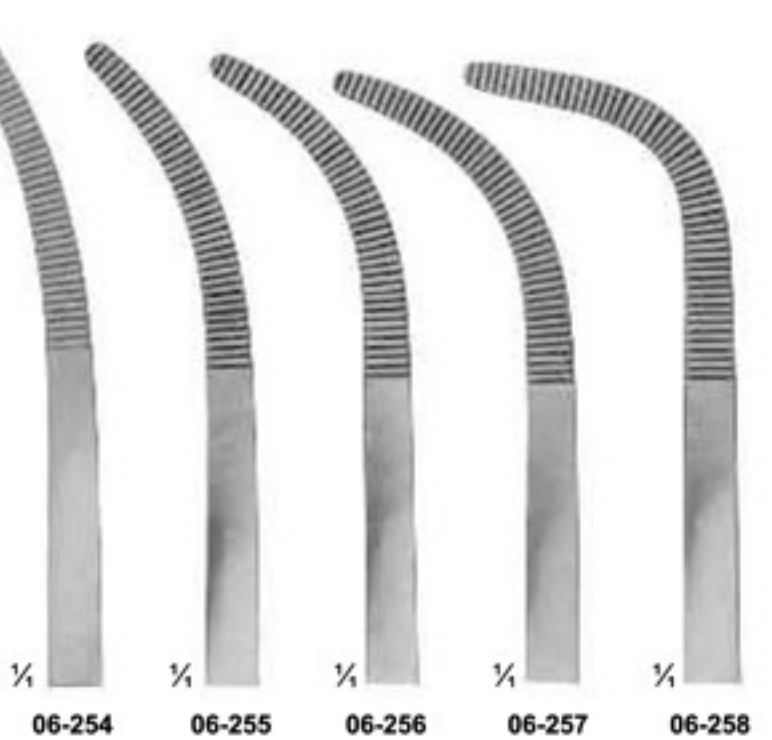

$\frac{1}{4}$ **06-254** $\frac{1}{4}$ **06-255** $\frac{1}{4}$ **06-256** $\frac{1}{4}$ **06-257** $\frac{1}{4}$ **06-258**

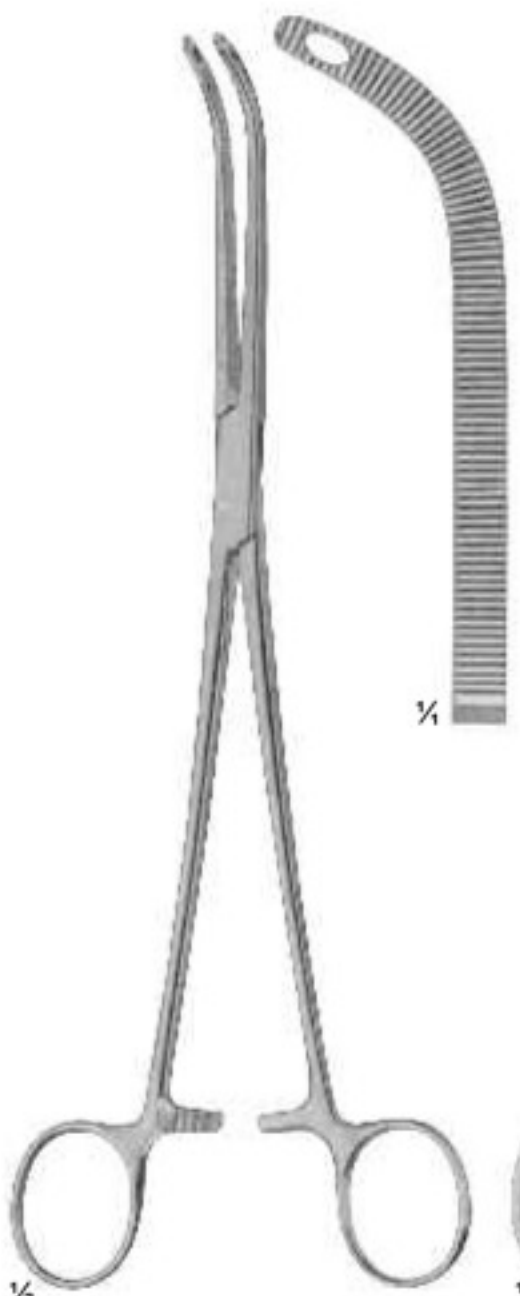

$\frac{1}{2}$
06-259
 FINOCHIETTO
 245 mm

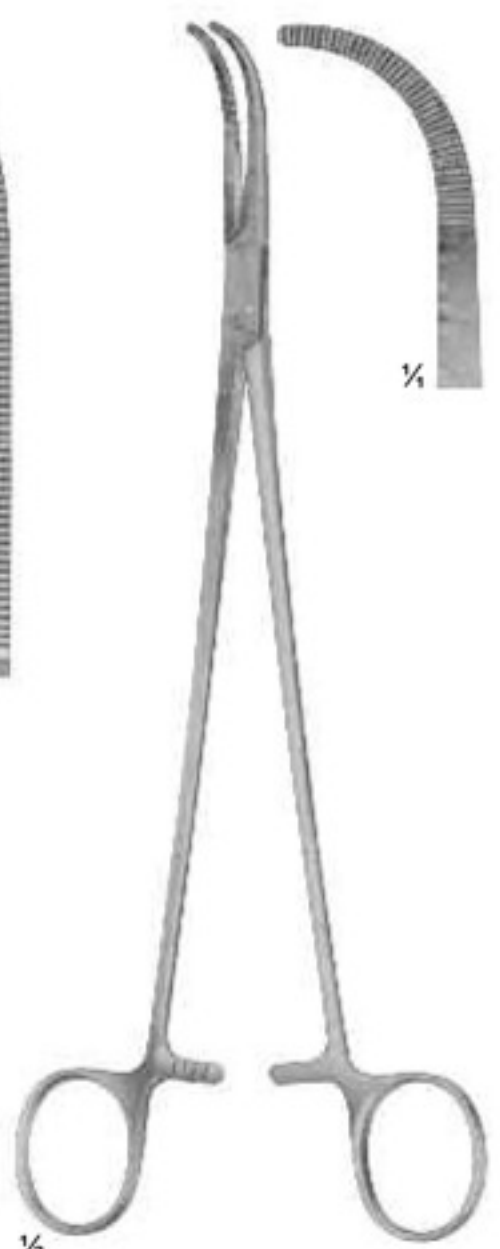

$\frac{1}{2}$
06-260
 MIXTER
 230 mm



$\frac{1}{2}$
06-261
 LAWRENCE
 270 mm

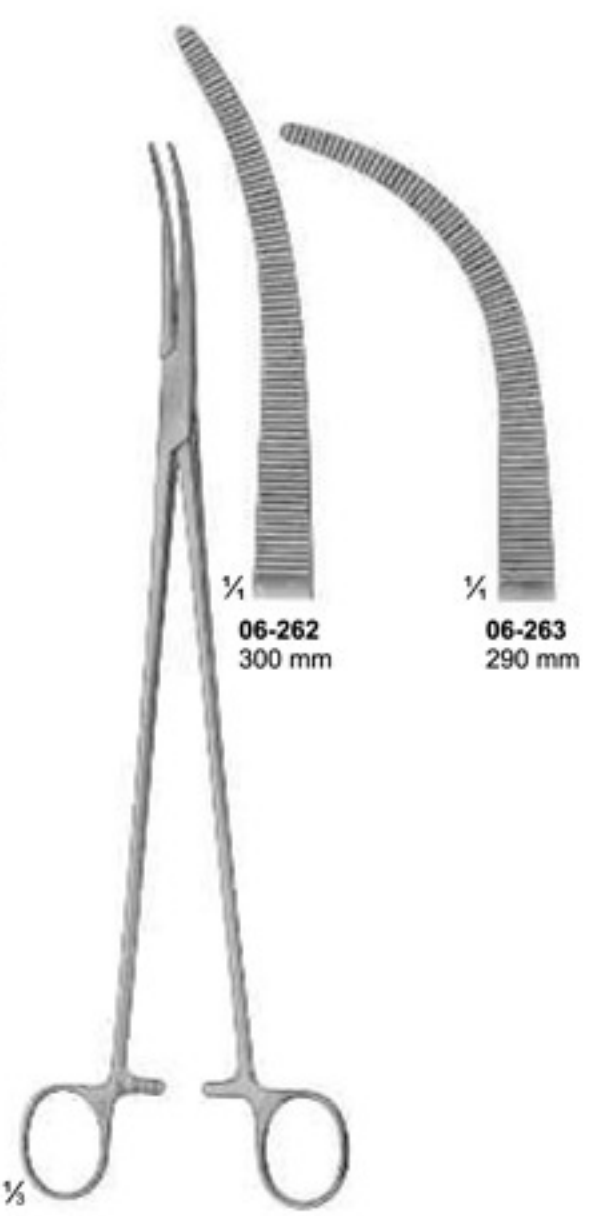

$\frac{1}{2}$
06-262 - 263
 ZENKER

$\frac{1}{4}$ **06-262**
 300 mm

$\frac{1}{4}$ **06-263**
 290 mm

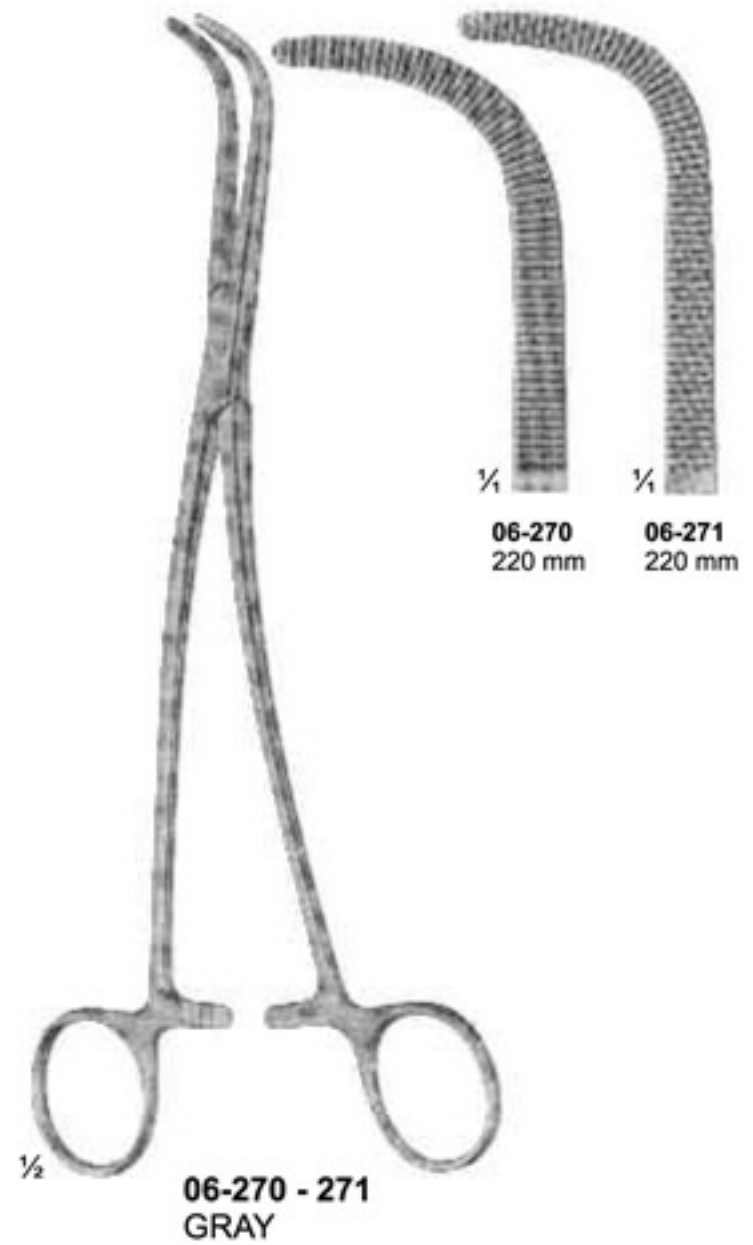
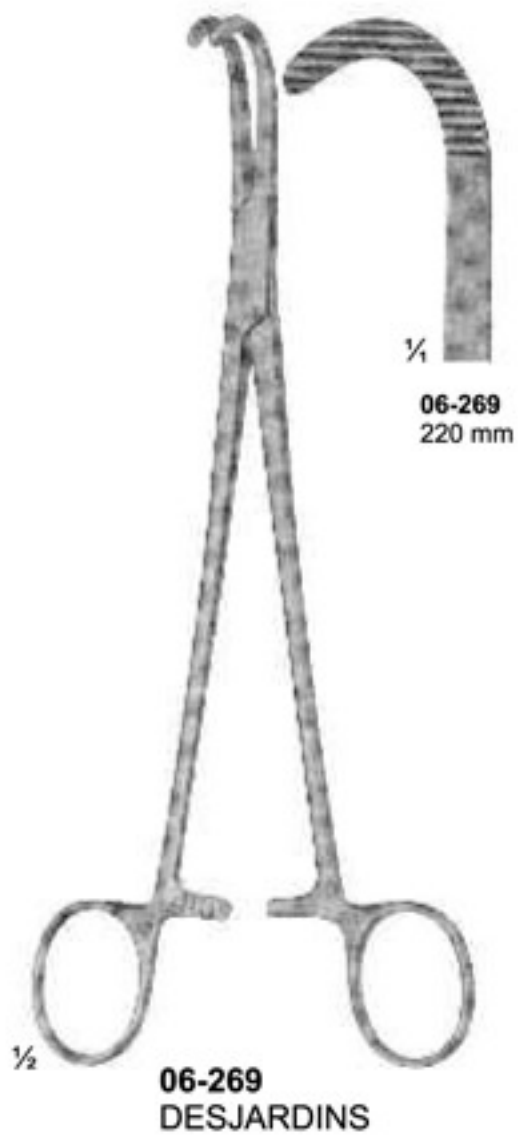
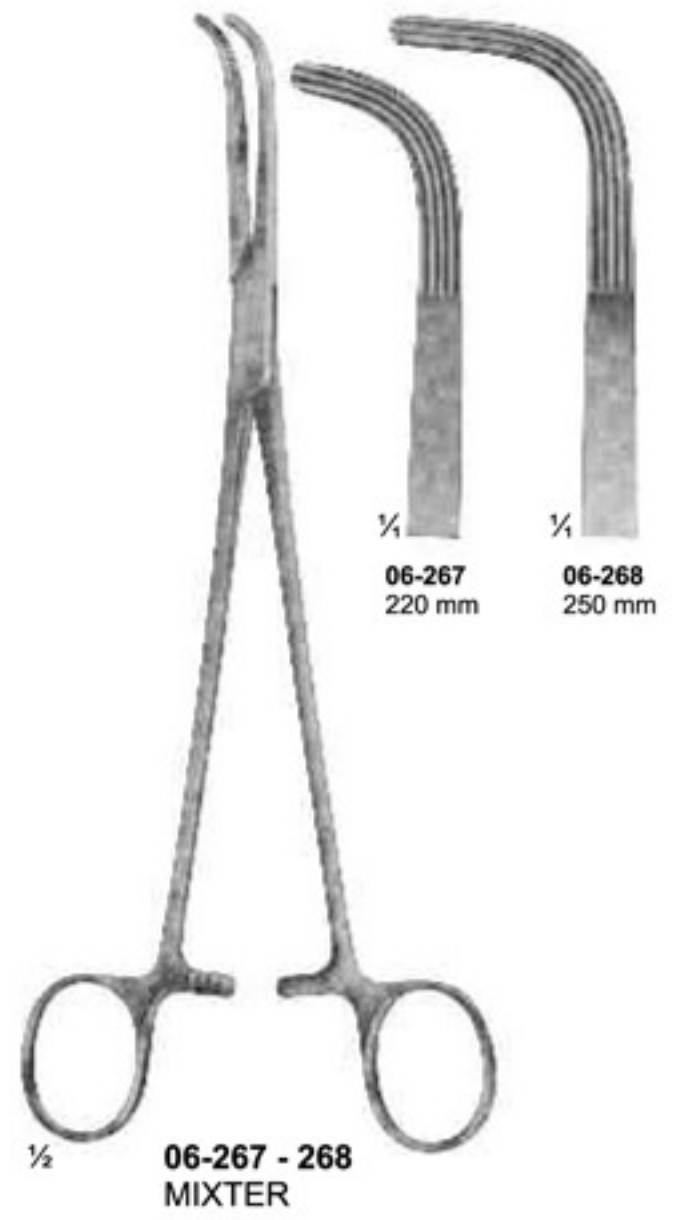
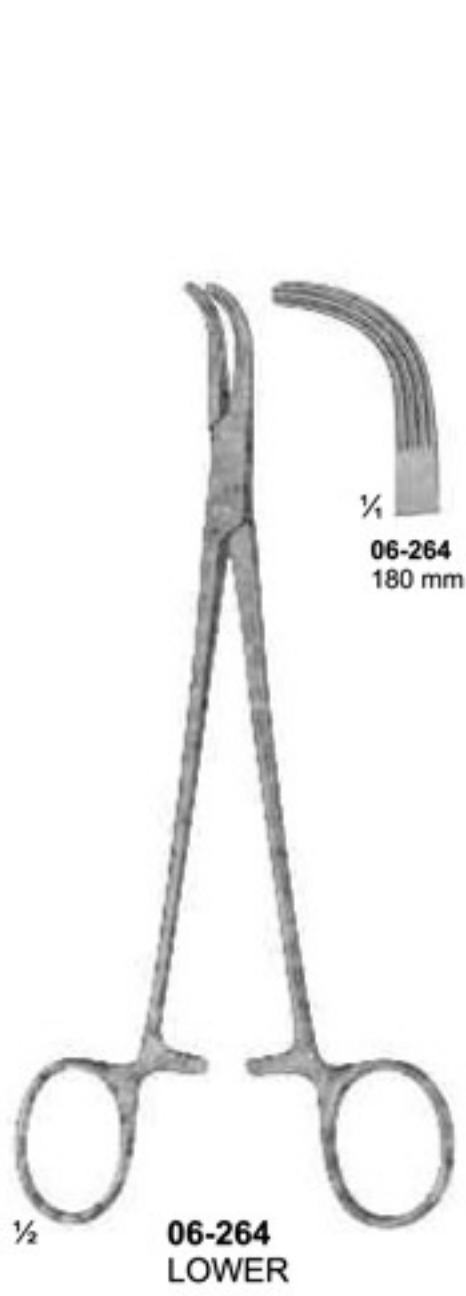



06-272
BABY-MIKULICZ
140 mm

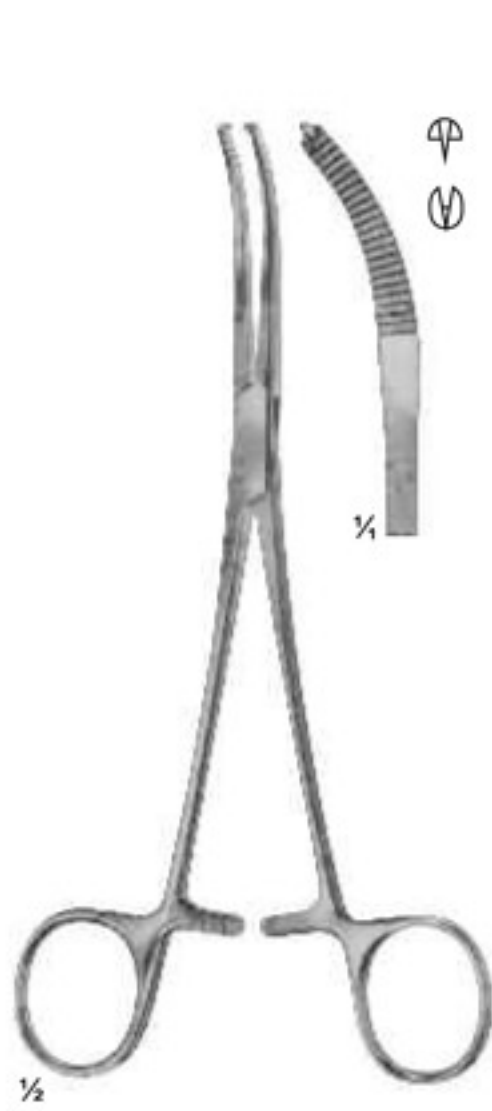

06-273
MIKULICZ
185 mm

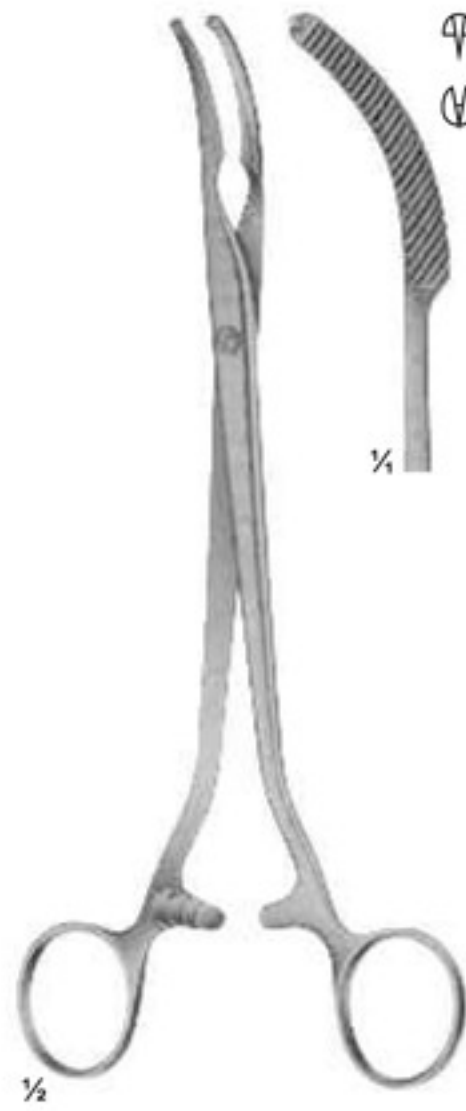

06-274
MIKULICZ
205 mm

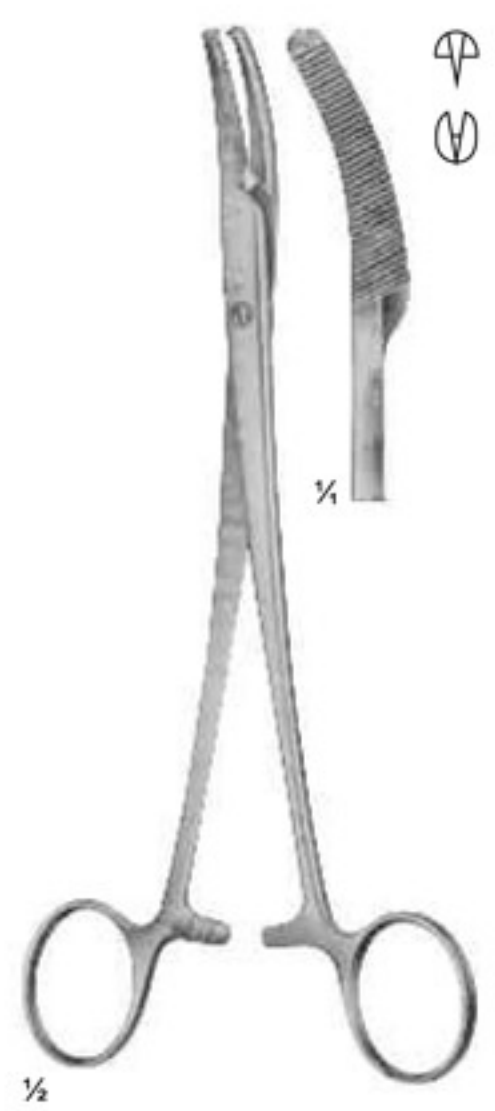

06-275
MIKULICZ
200 mm

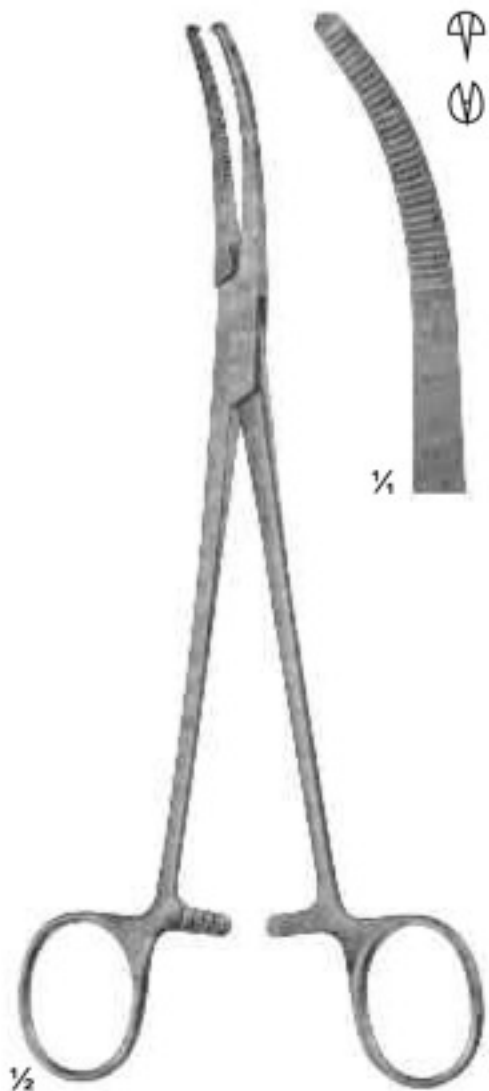

06-276
MIKULICZ
205 mm

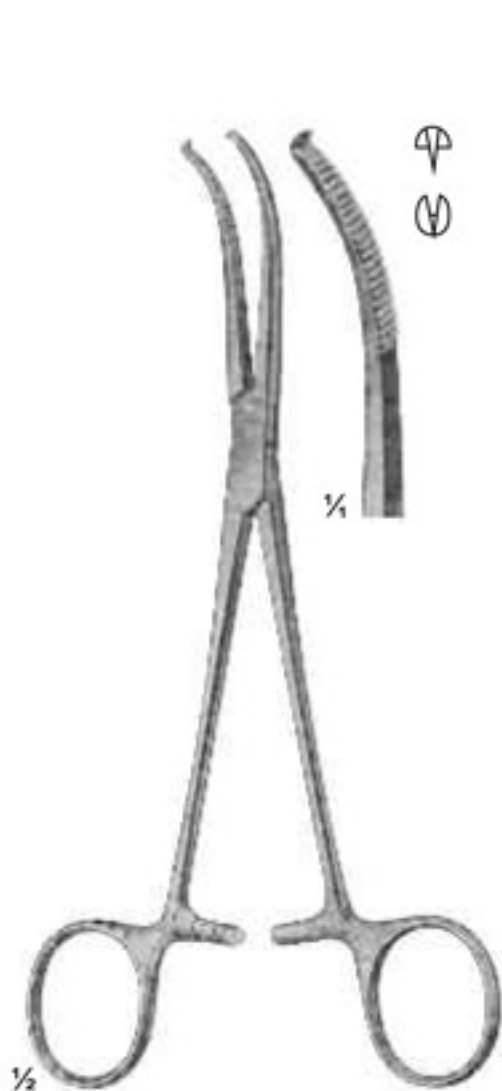

06-277
MIKULICZ
185 mm

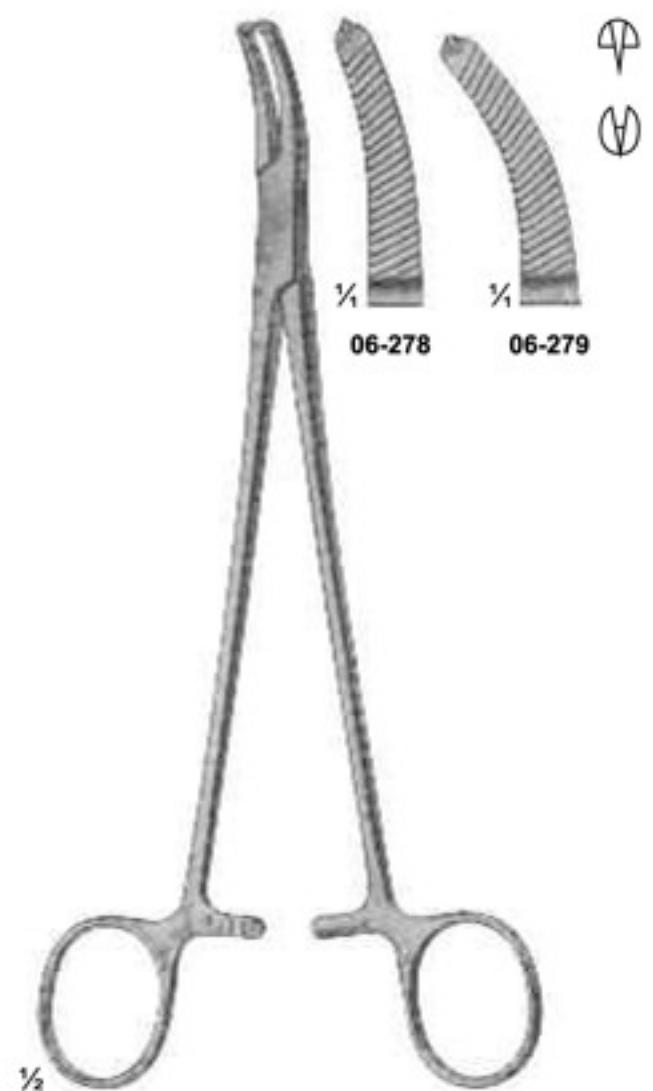

06-278 - 279
FAURE
205 mm

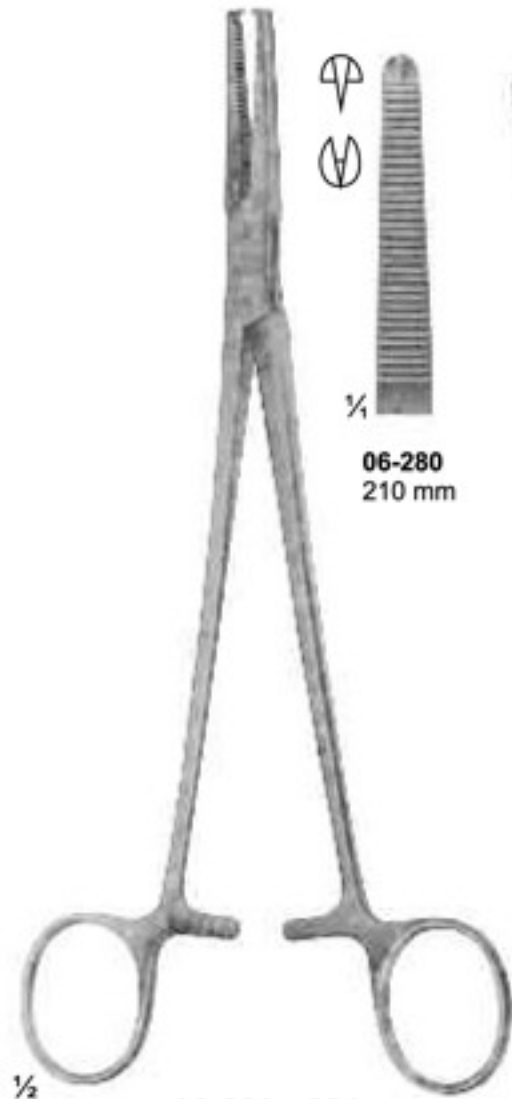

06-280 - 281
PHANEUF

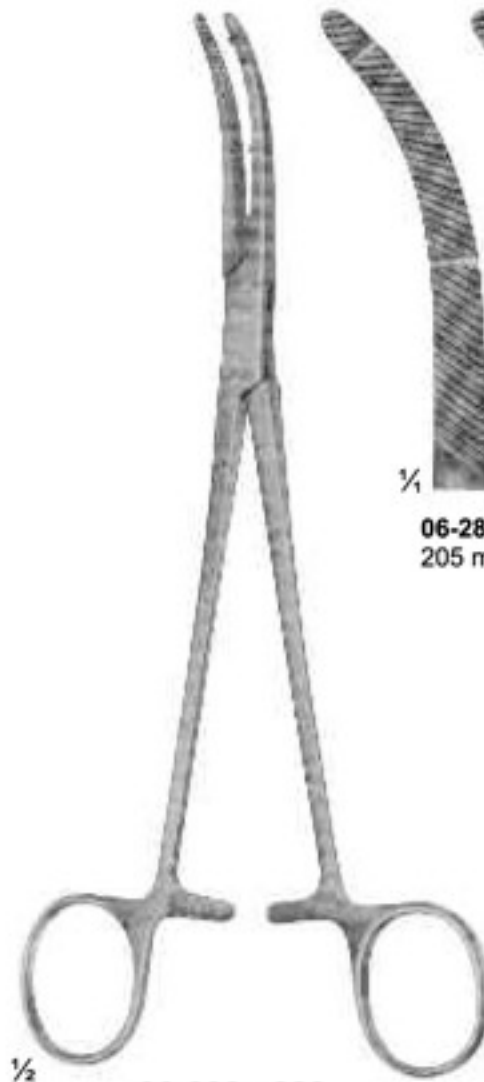
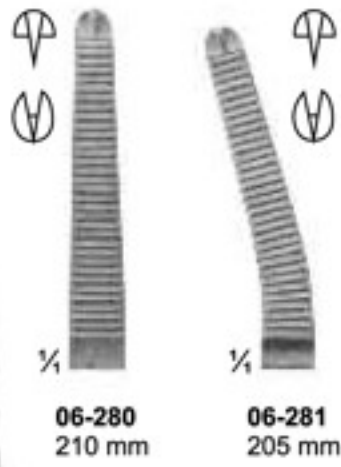

06-282 - 283
HEANEY modif.

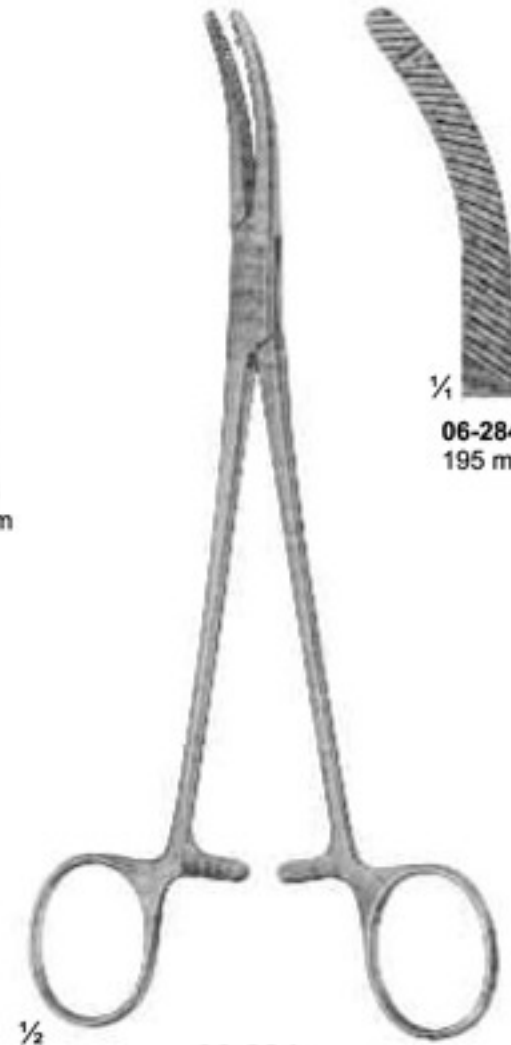

06-284
HEANEY

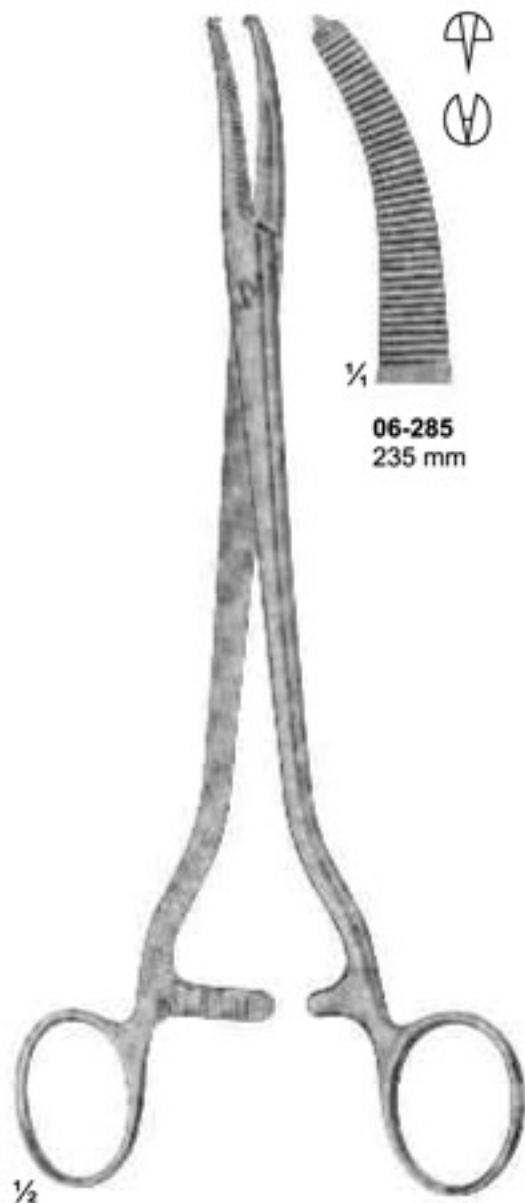

06-285
WERTHEIM

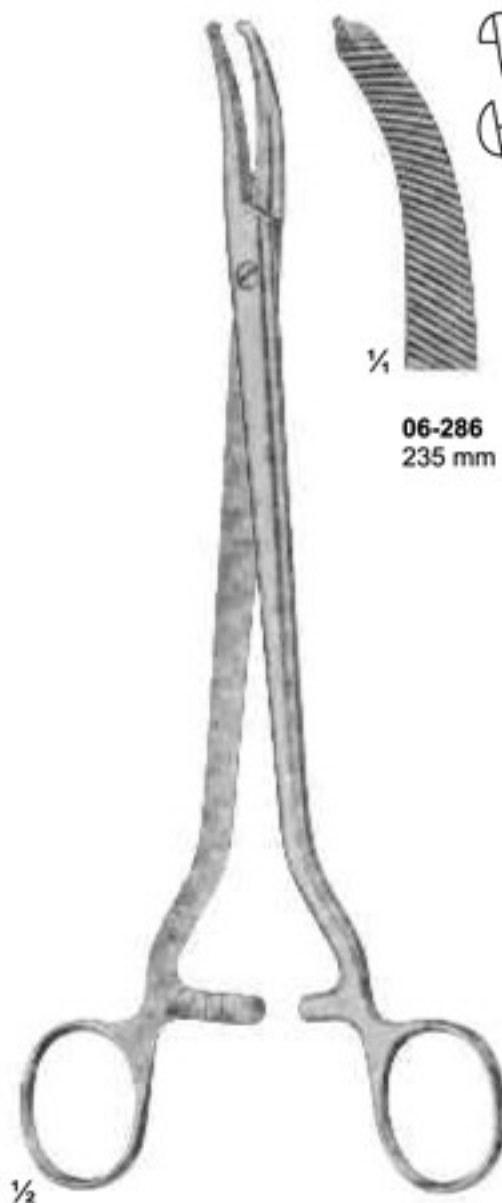

06-286
WERTHEIM

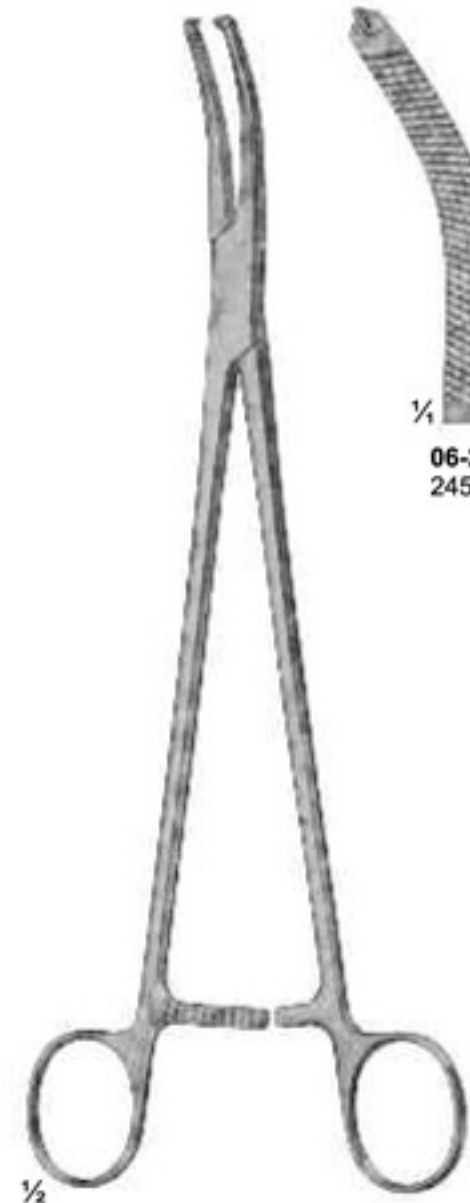

06-287
WERTHEIM



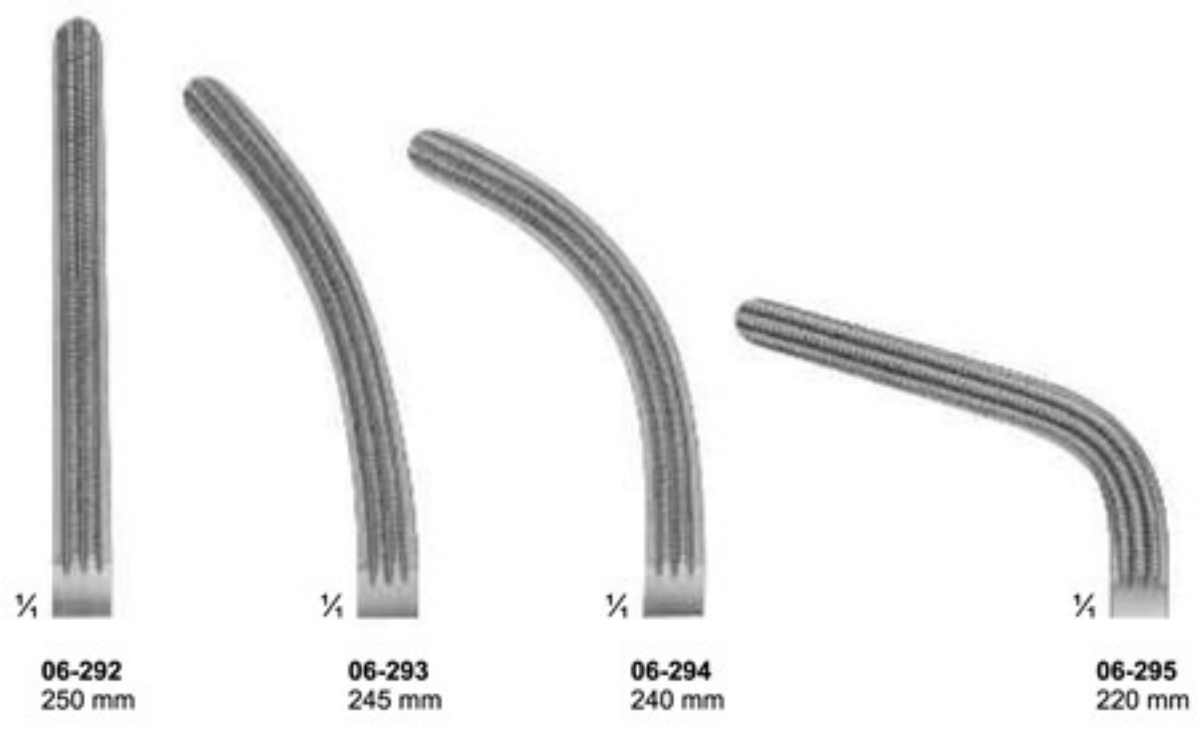
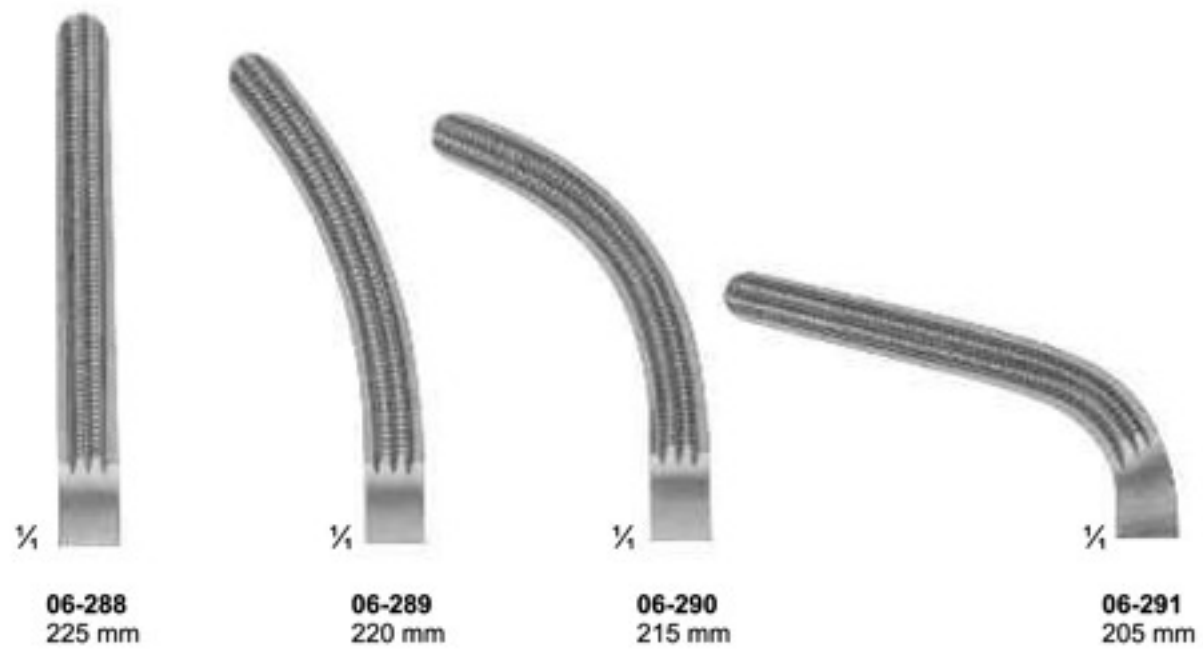

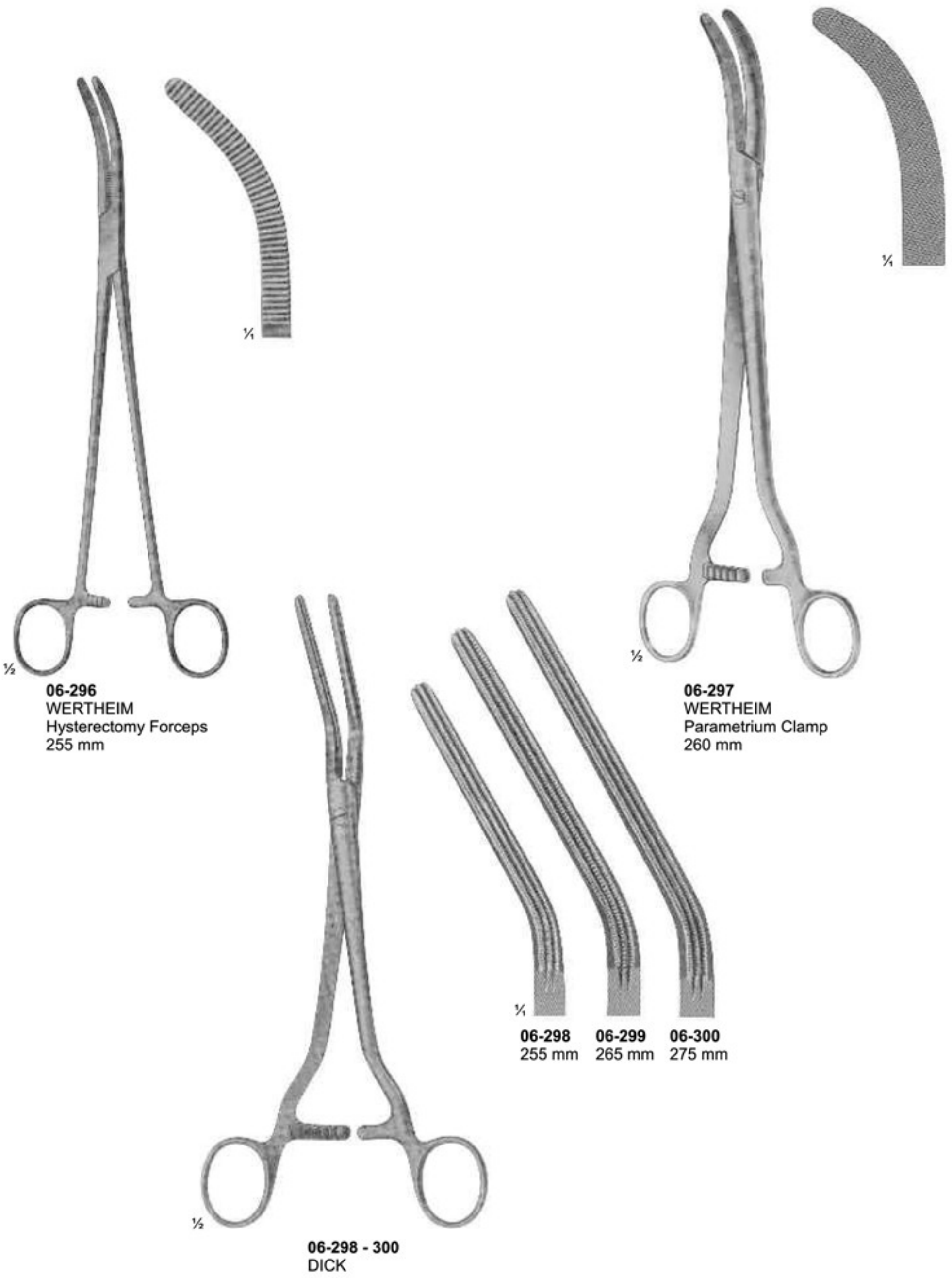

½
06-296
WERTHEIM
Hysterectomy Forceps
255 mm

½
06-297
WERTHEIM
Parametrium Clamp
260 mm

¼
06-298 255 mm **06-299** 265 mm **06-300** 275 mm

½
06-298 - 300
DICK

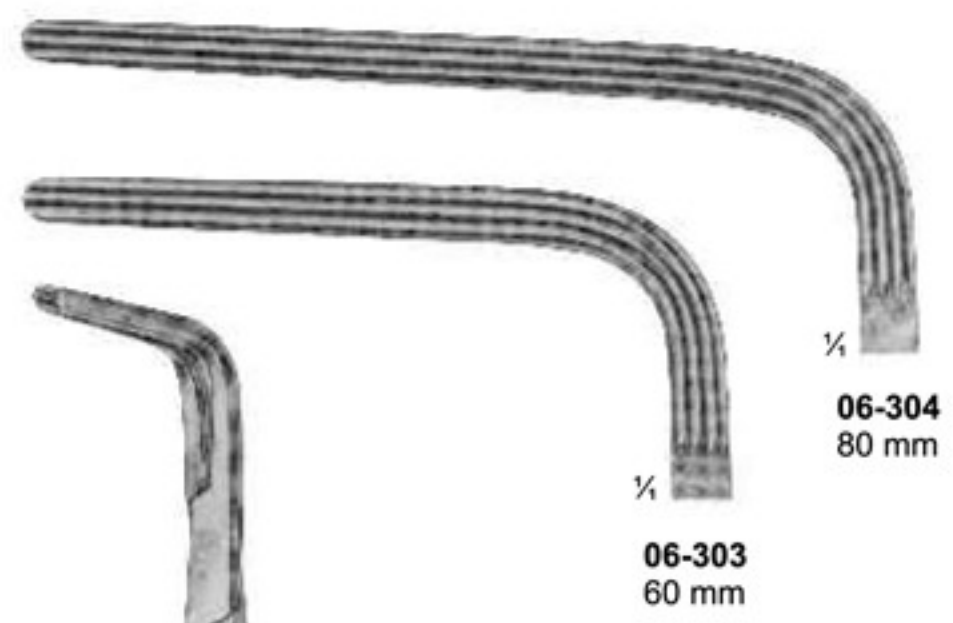
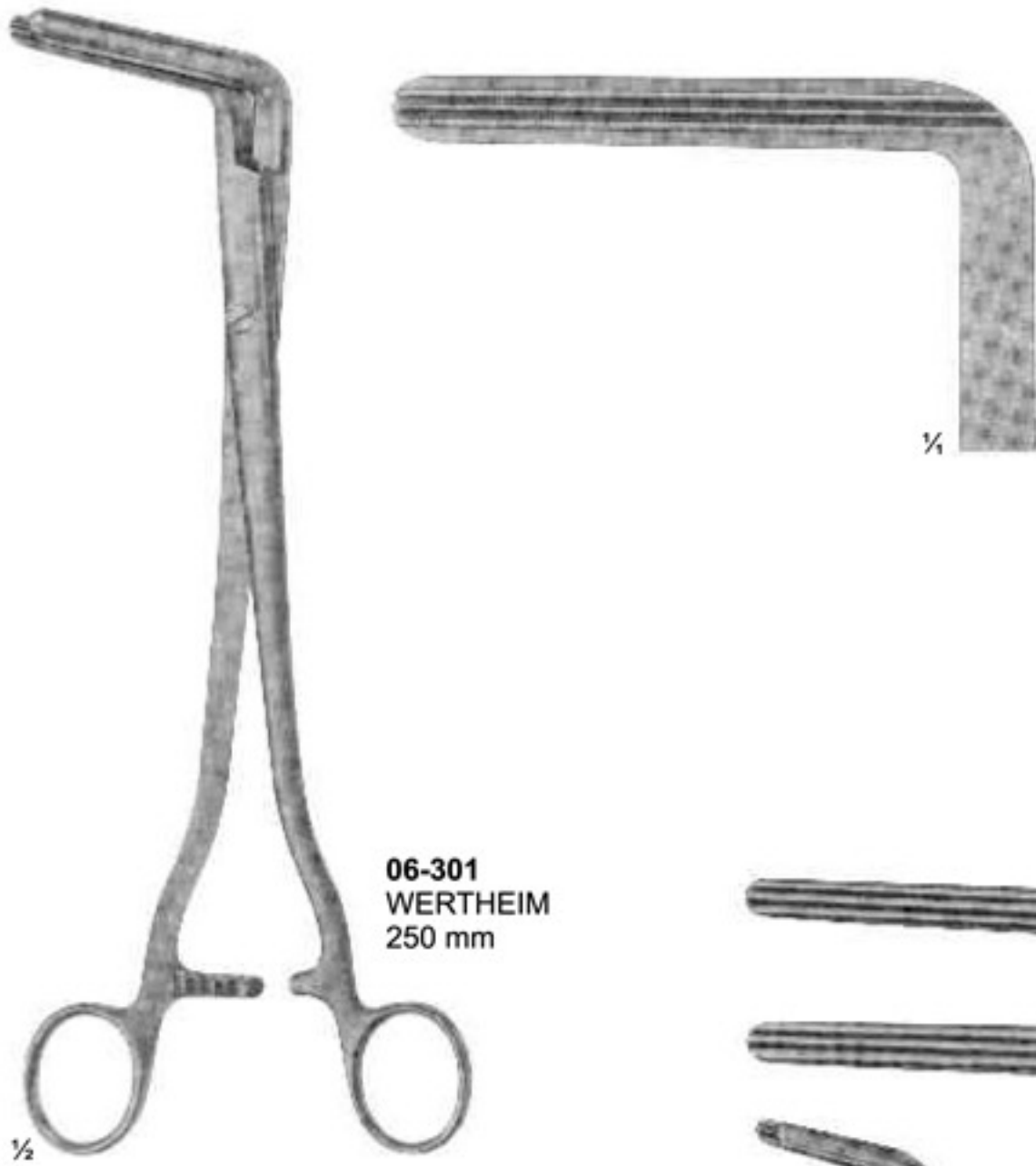



07-101
ROHRSCHEIDER
With copper inserts
100 mm



07-102
KALT
With catch
135 mm



07-103
ARRUGA
With catch
135 mm



07-104 - 105
CASTROVIEJO
With catch
145 mm



07-106 - 107
CASTROVIEJO
With Catch
160 mm



07-108 - 109
Without catch
185 mm



07-109



07-110 - 111
JACOBSON
185 mm



07-111
With catch

07-110
Without catch



07-112
Without catch
195 mm



07-113 - 114
YASARGIL
With catch
200 mm

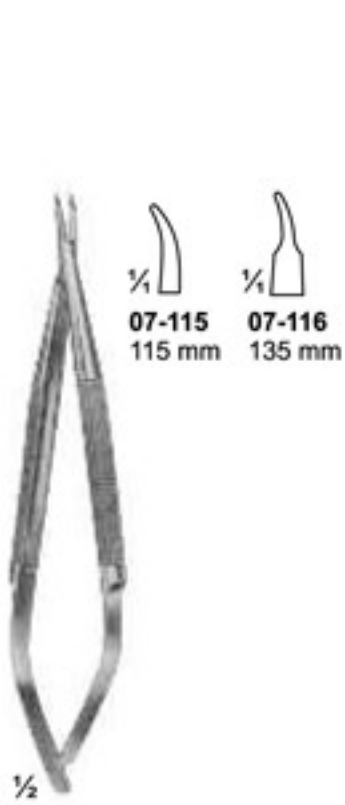

07-115 116
BARRAQUER
Without catch



07-117 - 118
BARRAQUER
Without catch
120 mm



07-119 - 120
BARRAQUER
With catch
120 mm



07-121 - 122
BARRAQUER
With Catch
150 mm



07-123
MULLER
With Locking
Mechanism
145 mm

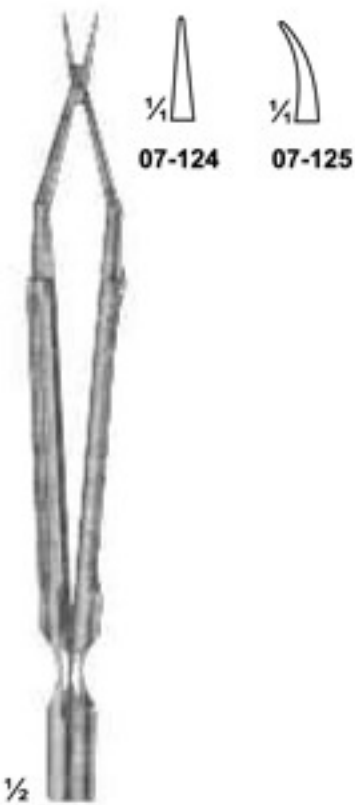

07-124 - 125
BROCK
Without catch
150 mm



07-126 - 127
YASARGIL
200 mm



07-128 - 129
YASARGIL
225 mm



07-130
YASARGIL
245 mm



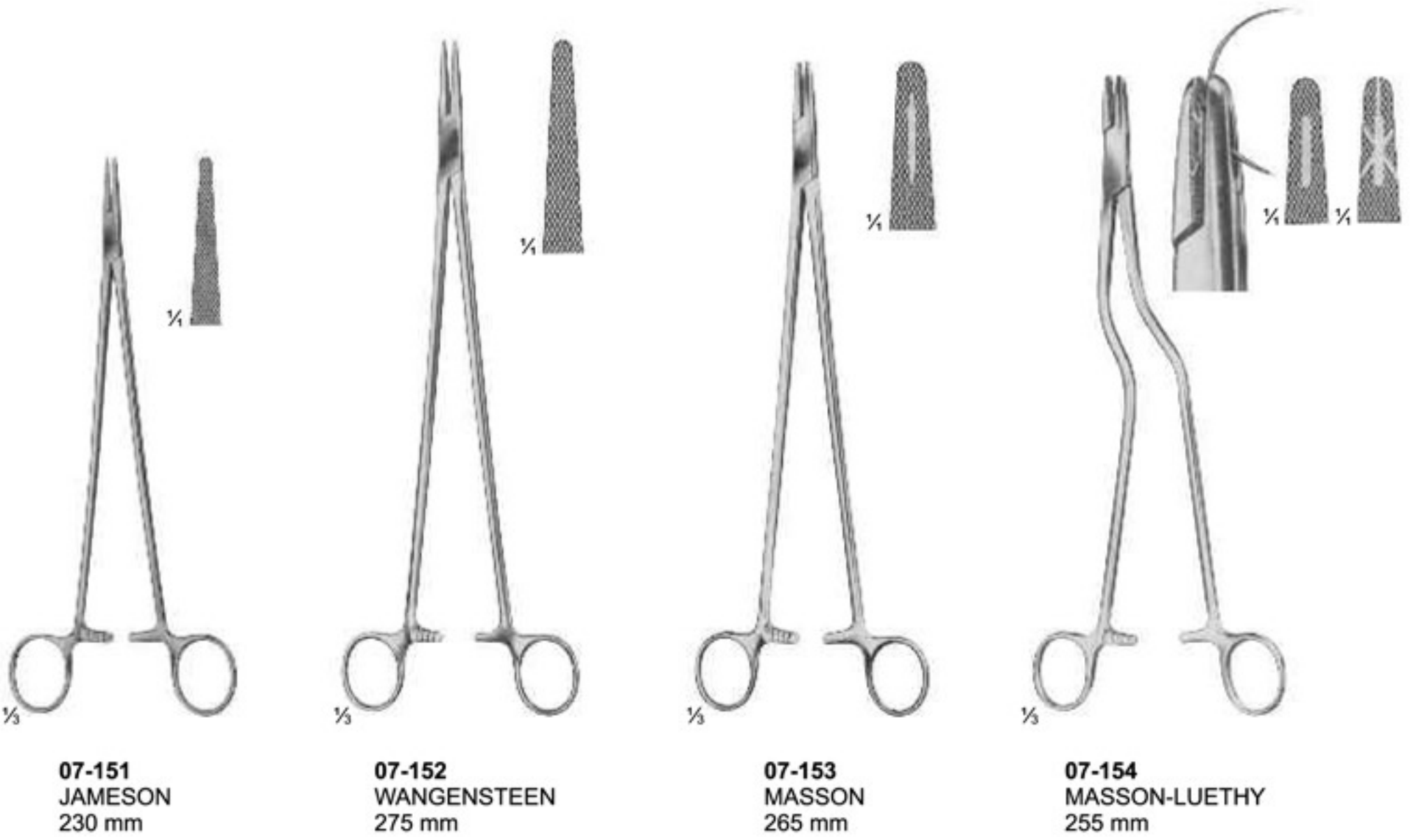
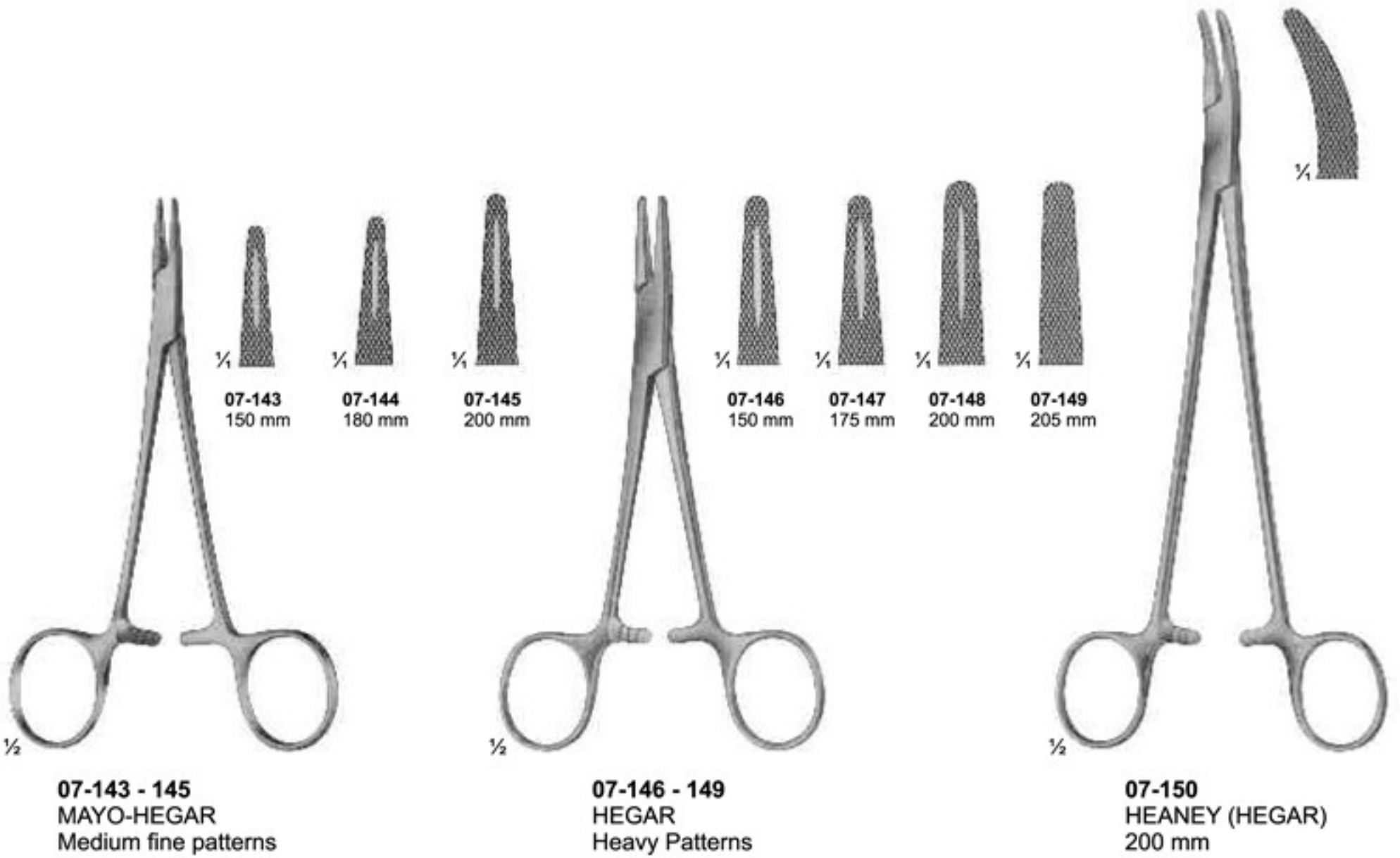

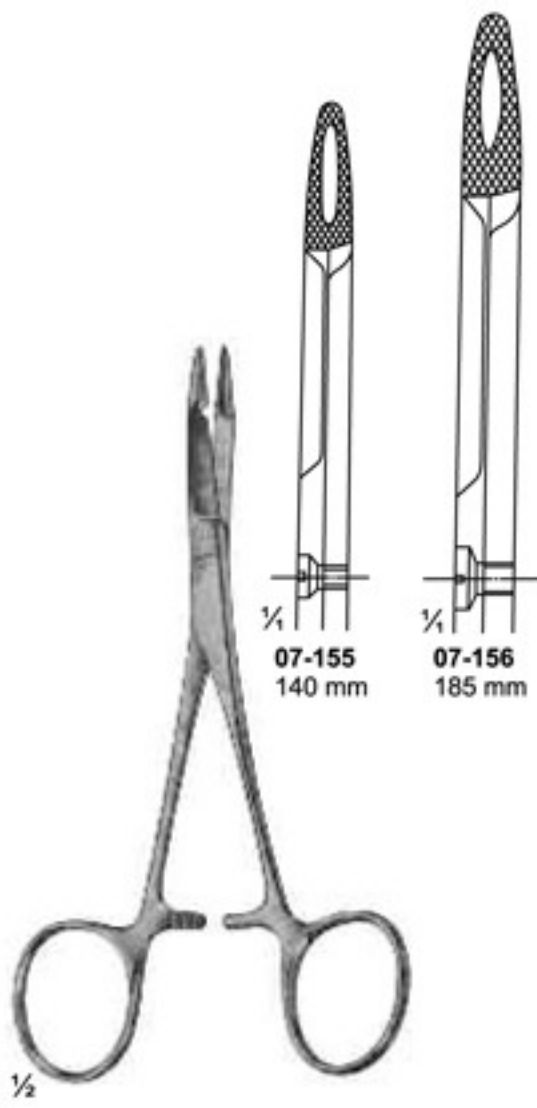

07-155 - 156
HEGAR-OLSEN
255 mm

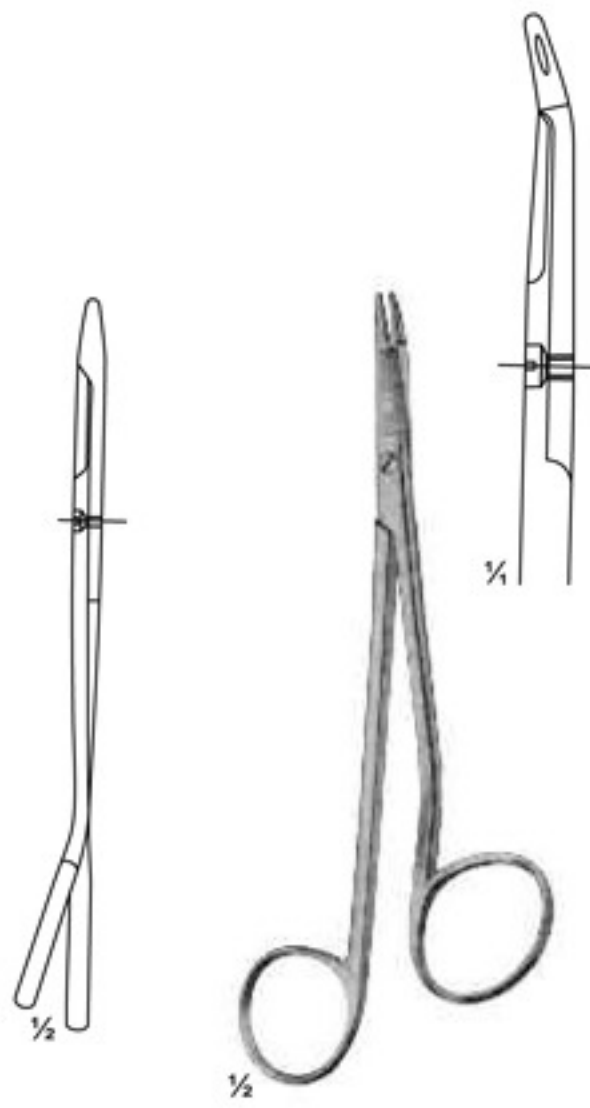

07-157
GILLIES
150 mm

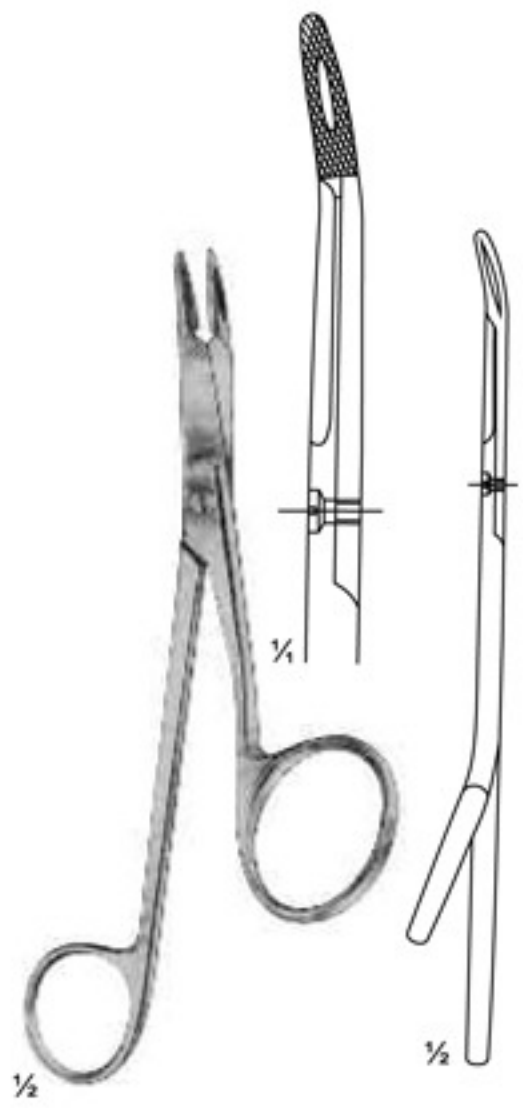

07-158
GILLIES
160 mm

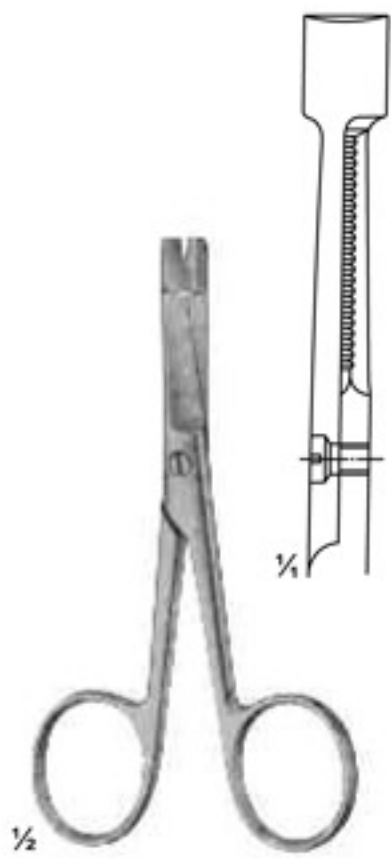

07-159
EISELSBERG
115 mm

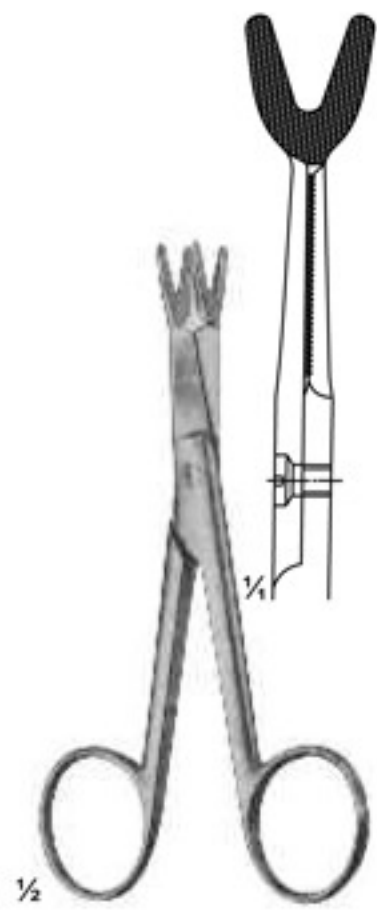

07-160
SCHOEMAKER-LOTH
125 mm



07-161
CRILE
150 mm



07-162
TONNIS
Elastic pattern for
dura-or intestinal suture
180 mm

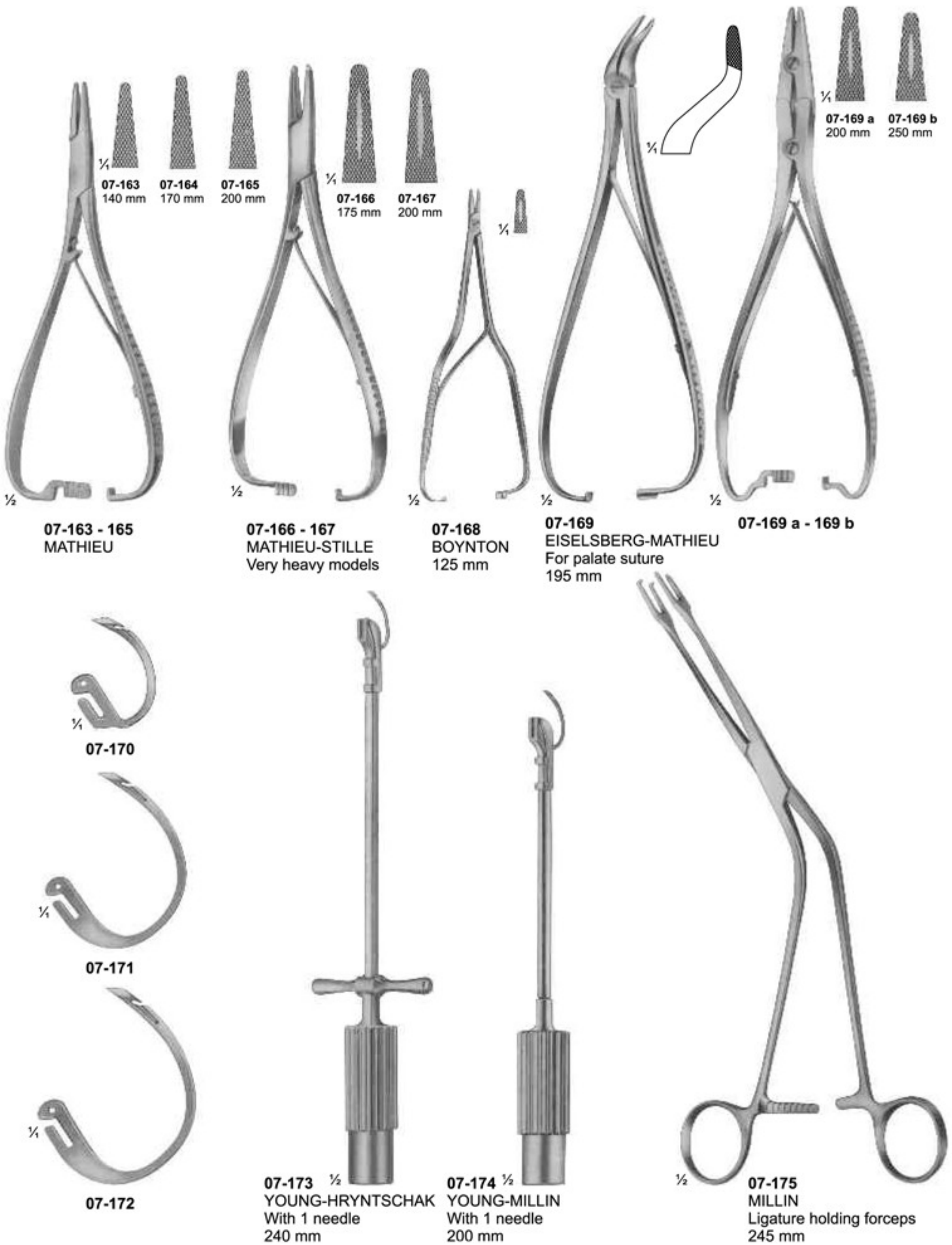



07-176 - 179
REVERDIN
140 mm



07-180 - 183
REVERDIN
195 mm

07-184 - 188
REVERDIN
220 mm

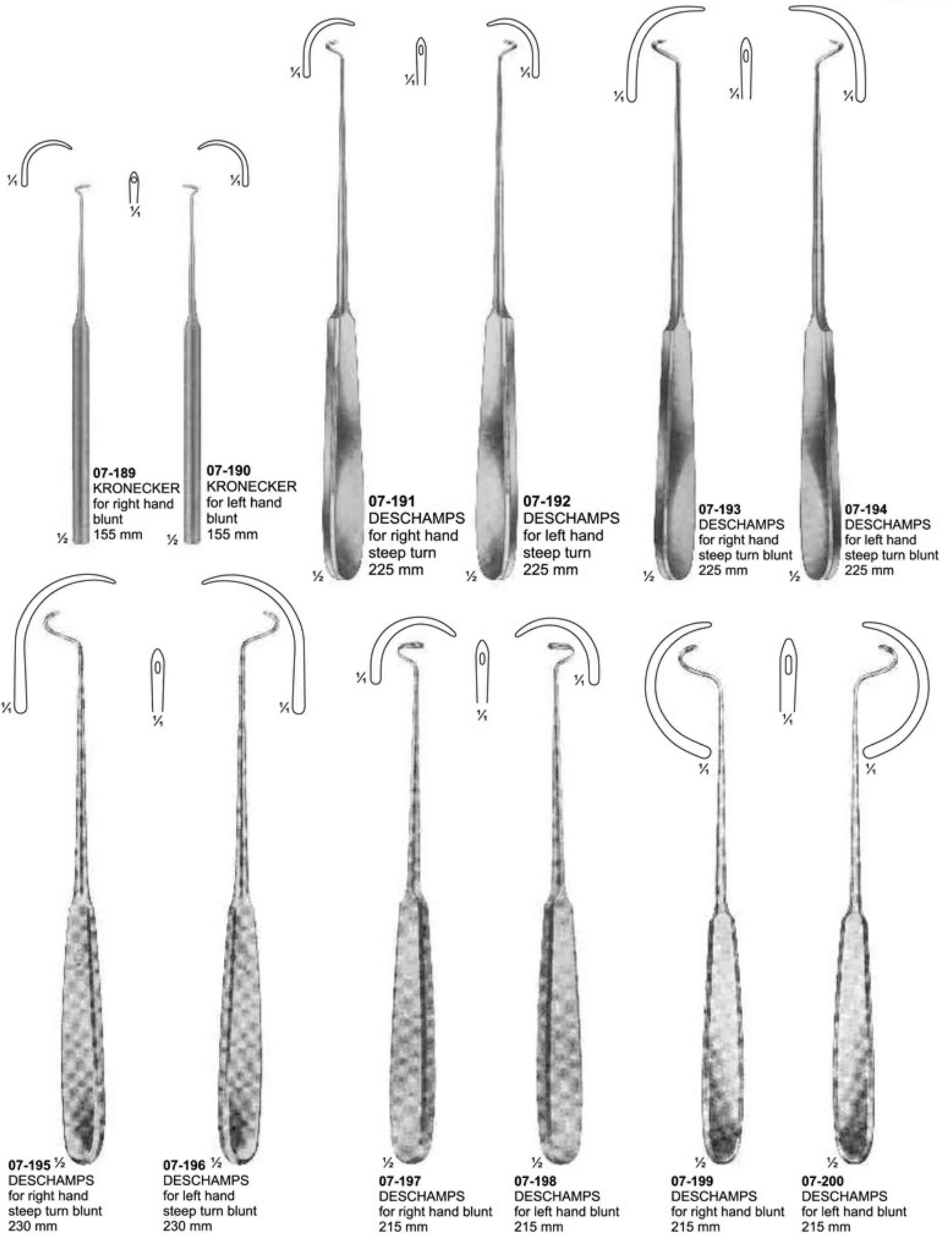



07-201
HURD
for right hand
sharp
210 mm



07-202
HURD
for left hand
sharp
210 mm



07-203
DESCHAMPS
for right hand
sharp
215 mm



07-204
DESCHAMPS
for left hand
sharp
215 mm



07-205
JONESCO
Needle for wire suture
185 mm



07-206
CLAUS VAN EICKEN
Needle for wire suture
250 mm

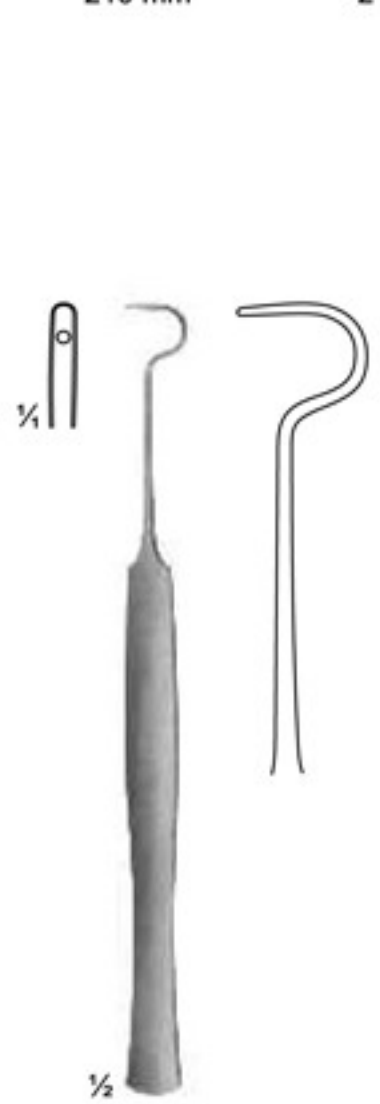

07-207
150 mm

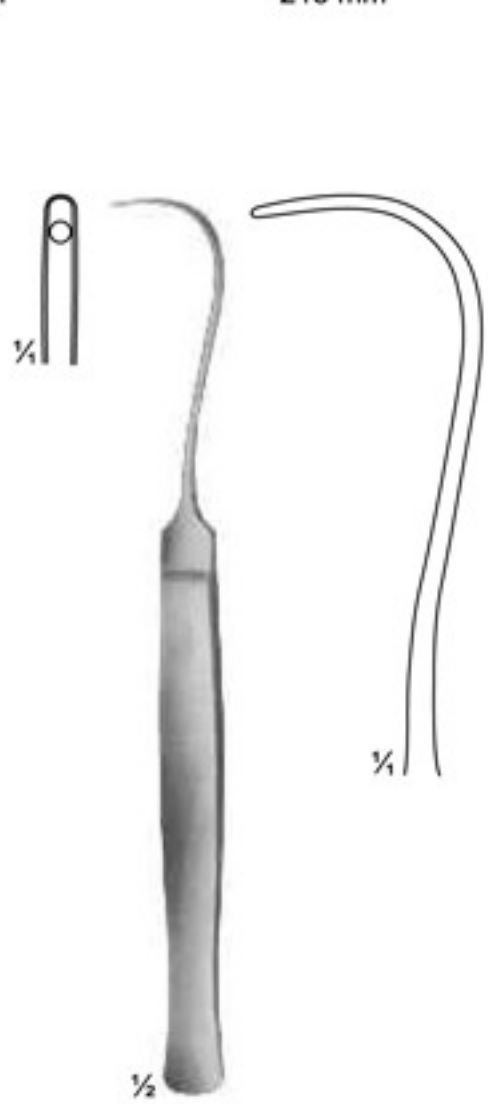

07-208
SYME
170 mm

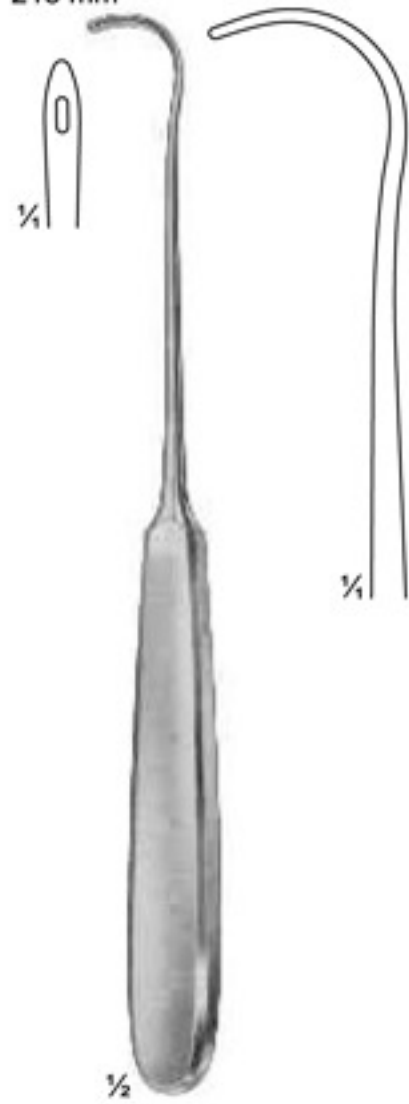

07-209
COOPER
205 mm

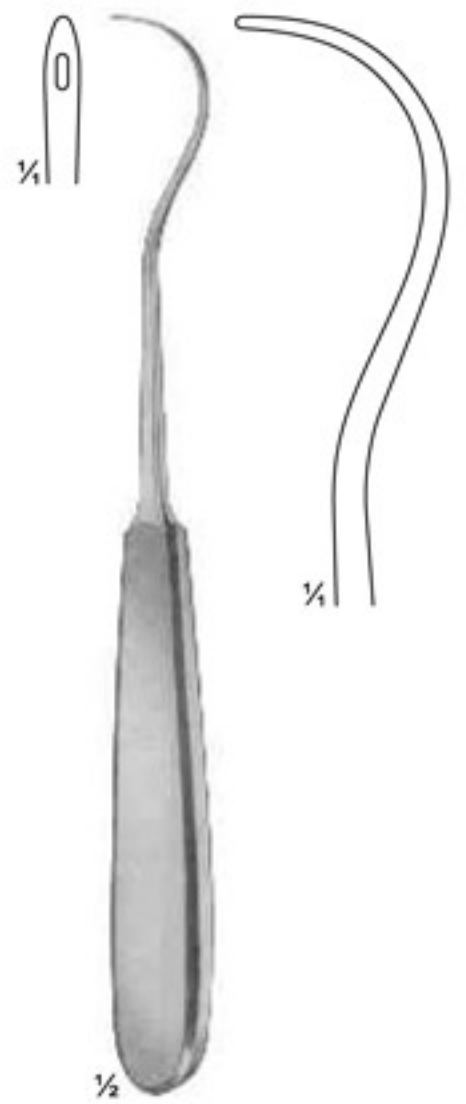

07-210
KOCHER
205 mm

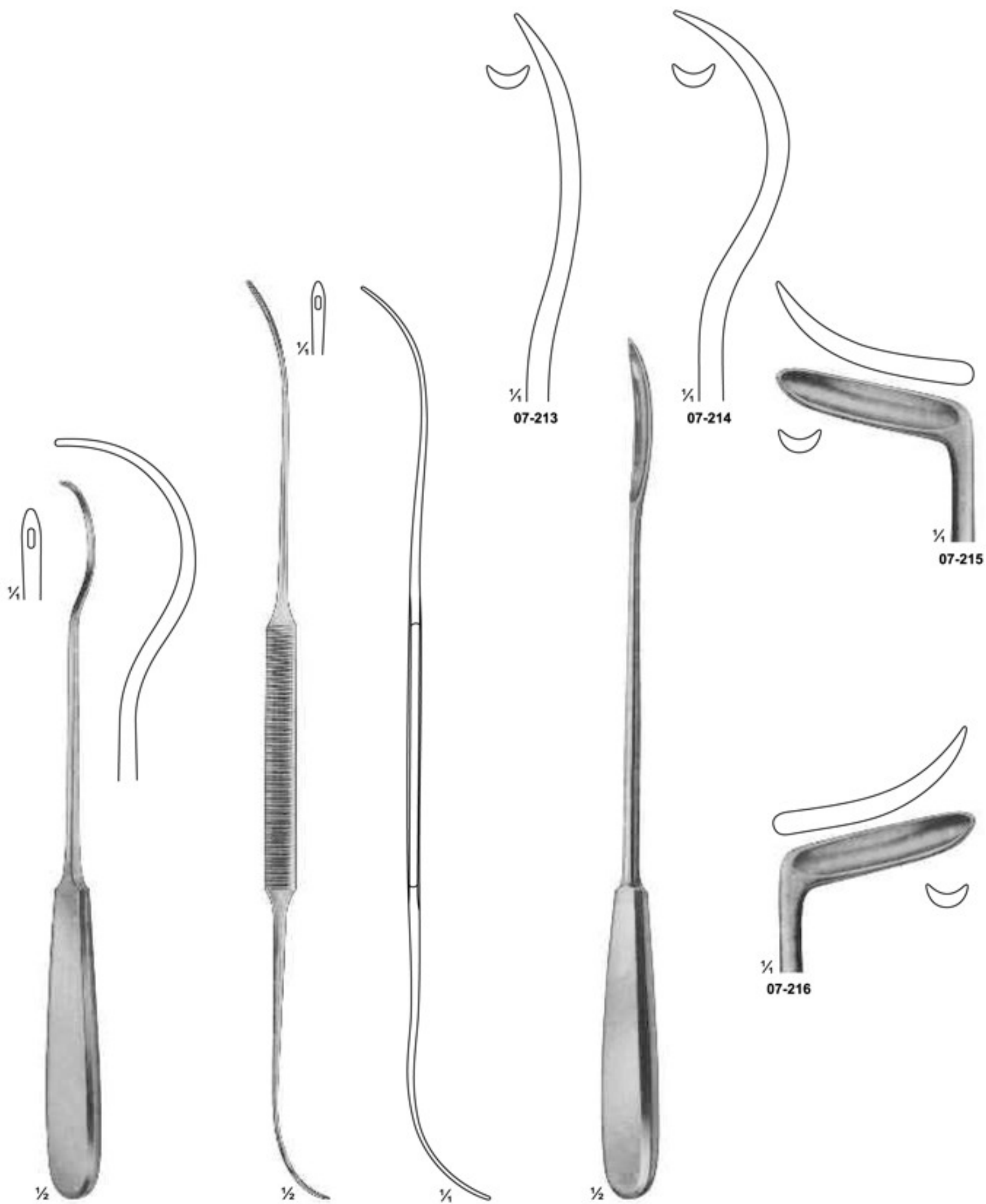

07-211
BRUNNER
240 mm

07-212
SCHMIEDEN-DICK
320 mm

07-213 - 216
BRUNNER
Guiding Probes
300 mm

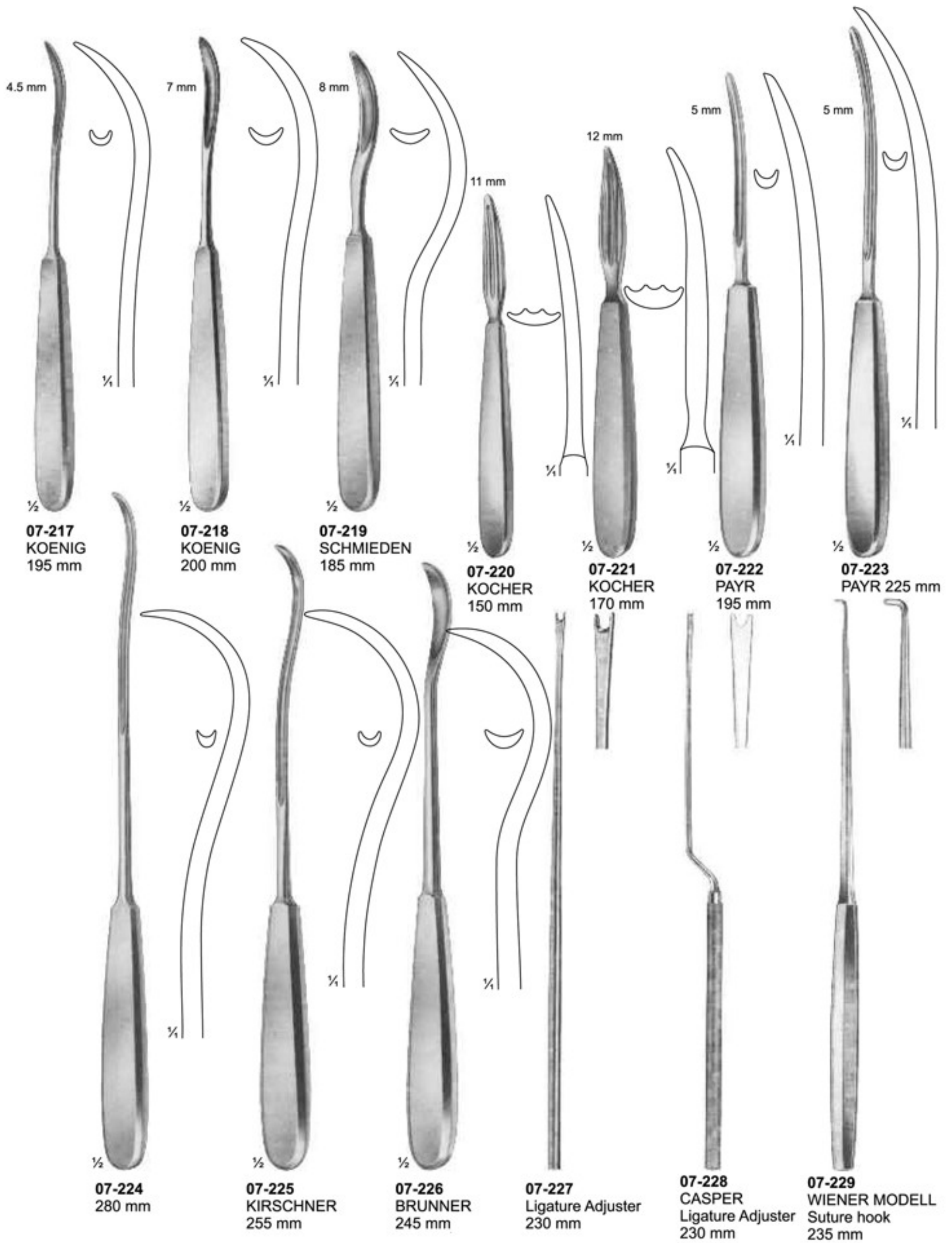



07-242 2,5 mm
07-243 2,5 mm
07-244 3,0 mm

1/2

07-242 145 mm
07-243 160 mm
07-244 200 mm
 Probes with eye



1,5 mm

1/2

07-245
 Myrtle leaf probe
 145 mm



2,0 mm

1/2

07-246 130 mm
07-247 145 mm
07-248 160 mm
07-249 180 mm
07-250 200 mm



1/2

07-251
 Probes



1/2

07-252
 Double ended probe,
 malleable, diam. of tips
 3 mm with hole
 190 mm



07-253
 Double ended probes,
 tin, malleable,
 diam. of tips
 3,5 mm with hole
 250 mm, 300 mm



1/4

07-254
 Double ended probes,
 tin, malleable,
 diam. of tips 4 mm
 400 mm



1/3

\varnothing tip
07-255 1,5 mm
07-256 2,0 mm
07-257 2,5 mm
 300 mm

07-242
2,5 mm
07-243
2,5 mm
07-244
3,0 mm



1/2

07-242 145 mm
07-243 160 mm
07-244 200 mm
Probes with eye

1,5 mm



1/2

07-245
Myrtle leaf probe
145 mm

2,0 mm



1/2

07-246 130 mm
07-247 145 mm
07-248 160 mm
07-249 180 mm
07-250 200 mm



1/2

07-251
Probes



1/2

07-252
Double ended probe,
malleable, diam. of tips
3 mm with hole
190 mm



07-253
Double ended probes,
tin, malleable,
diam. of tips
3,5 mm with hole
250 mm, 300 mm



1/4

07-254
Double ended probes,
tin, malleable,
diam. of tips 4 mm
400 mm



1/2

07-255 1,5 mm
07-256 2,0 mm
07-257 2,5 mm
300 mm

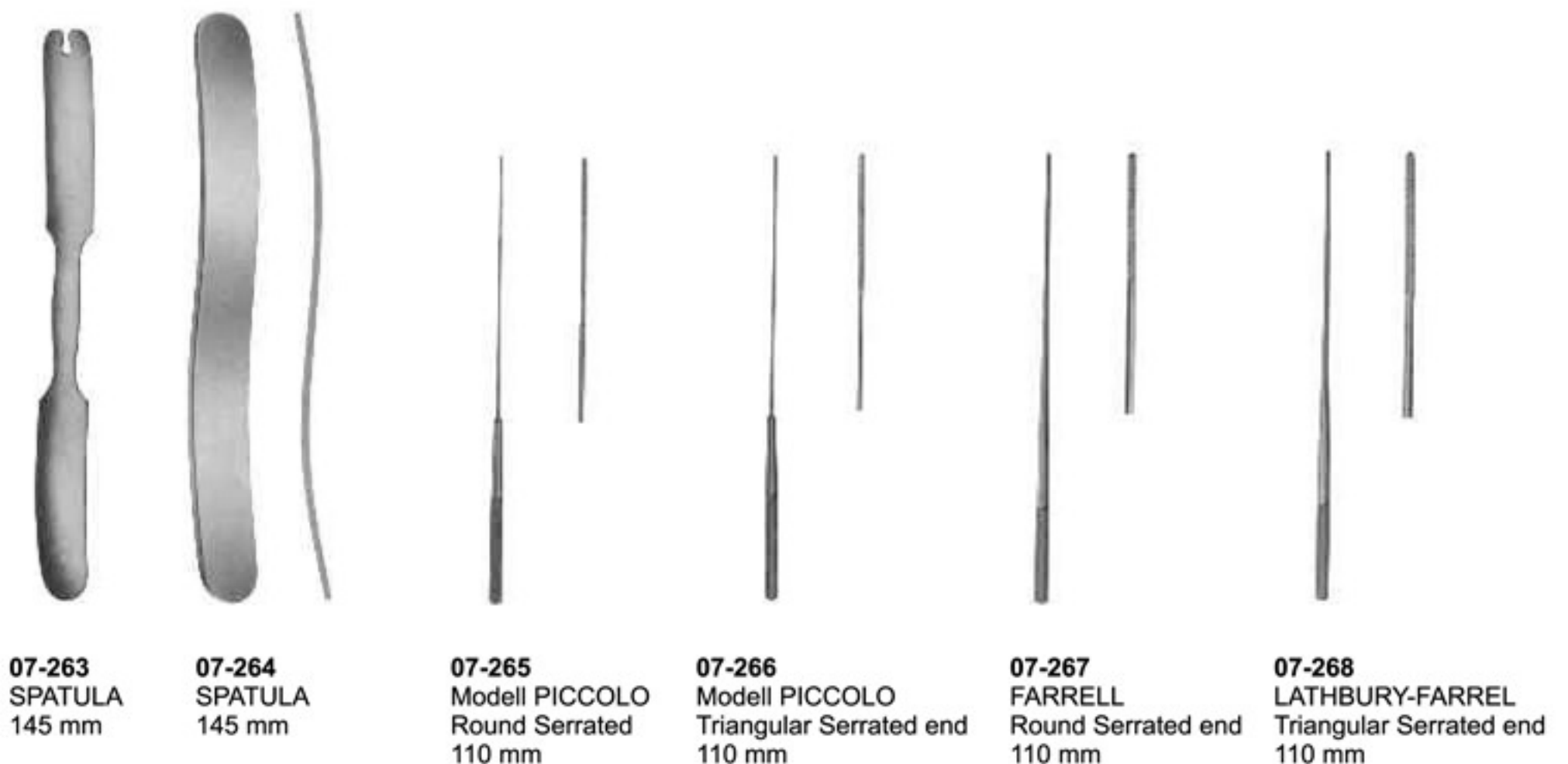
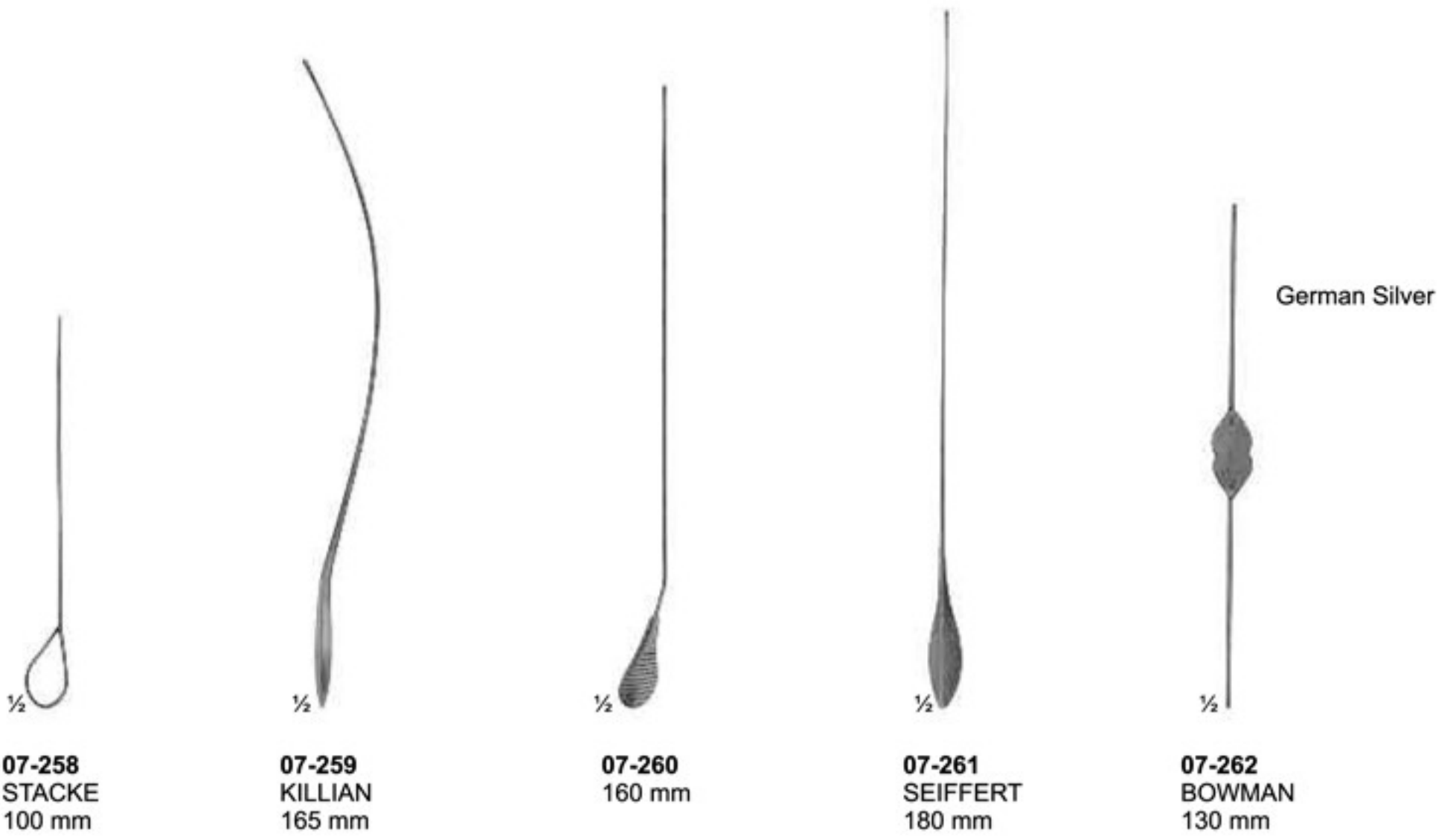

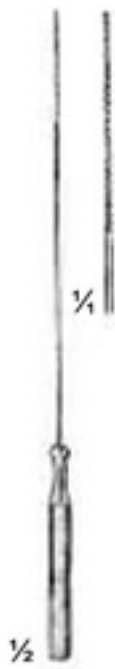

07-269
BUCK
Rough, spiral end
120 mm



07-270
LATHBURY-FARRELL
Triangular,
serrated end
140 mm

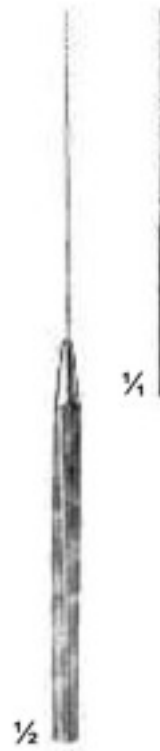

07-271
BUCK
Rough, spiral end
140 mm



07-272
BUCK
Rough, spiral end
140 mm



07-273
BUCK
Rough, spiral end
140 mm



07-274
FARRELL
Round,
serrated end
140 mm



07-275
LATHBURY-FARRELL
Triangular,
serrated end
140 mm



07-276
FARRELL
Rough,
spiral end
160 mm



07-277
LATHBURY-FARRELL
Triangular,
serrated end
160 mm



07-278
LATHBURY-FARRELL
Triangular,
serrated end
160 mm



07-279
BUCK
Rough,
spiral end
180 mm



07-280
BUCK
Rough,
spiral end
180 mm



07-281
BUCK
Rough,
spiral end
270 mm



½
07-282
MICHEL
125 mm



½
07-283
HEGENBARTH
120 mm



½
07-284
WACHENFELDT
120 mm



½
07-285
WACHENFELDT
120 mm



½
07-286
MICHEL
125 mm



½
07-287
MICHEL modif.
130 mm



½
07-288
HEATH
135 mm

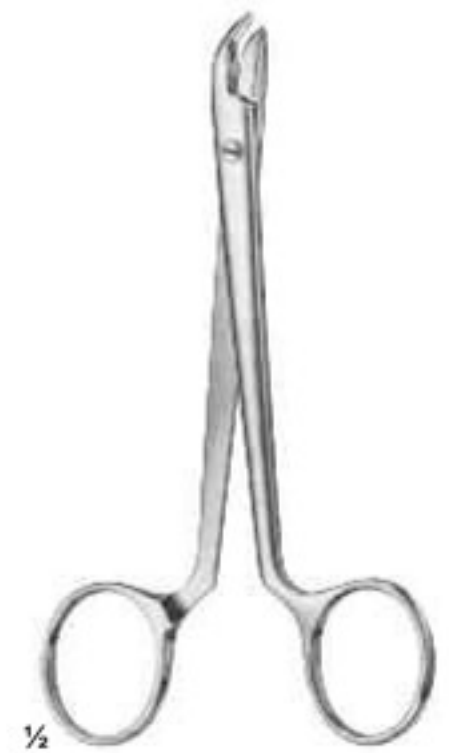

½
07-289
COLLIN
135 mm



07-290

Suturing instruments set, in metal case consisting of: Scissors, curved, sharp/sharp, 115mm
25 MICHEL clip, 16 x 3mm
1 Delicate tissue forceps, 130mm
1 Scalpel, bellied
1 MATHIEU needle holder, 140mm
1 Perforated metal case, stainless containing:
1 Suture needle
1 item 1 item



07-291

Pocket instrument set, in metal case consisting of:

Bottom tray

1 MATHIEU needle holder, 140mm
1 MICHEL clip forceps, combined
1 Myrtle leaf probe, 130mm
1 Sharp double curette
1 Skin hook
1 Detachable scalpel handle, no.4
1 Perforated metal case, containing
6 Scalpel blades BB 520
1 Perforated metal case, stainless, containing
1 Suture needle
1 item
1 item

Top tray

1 Tissue forceps, 130mm
1 KOCHER haemostatic forceps, 130mm
1 Straight surgical scissors, 130mm
1 Dissecting forceps, 130mm
1 FEILCHENFELD splinter forceps, 115mm
25 MICHEL clip, 16 x 3mm
1 Flacon of suture skin, sterile in alcohol



07-292

Pocket instrument set, in metal case consisting of:

Bottom tray

1 MAYO-HEGER needle holder, 150mm
1 MICHEL clip forceps, combined
1 Myrtle leaf probe, 130mm
1 Sharp double curette
1 Skin hook
1 Detachable scalpel handle, no. 4
1 Perforated metal case, consisting
6 Scalpel blades BB 520
1 Perforated metal case, stainless, consisting:
1 Suture needle
1 item, & 1 item

Bottom tray

1 Tissue forceps, 130mm
1 CRILE haemostatic forceps, 140mm
1 Straight surgical scissors, 130mm
1 Dissecting forceps, 130mm
1 FEILCHENFELD splinter forceps, 115mm
25 MICHEL clip, 16 x 3mm
1 Flacon of suture silk, sterile in alcohol

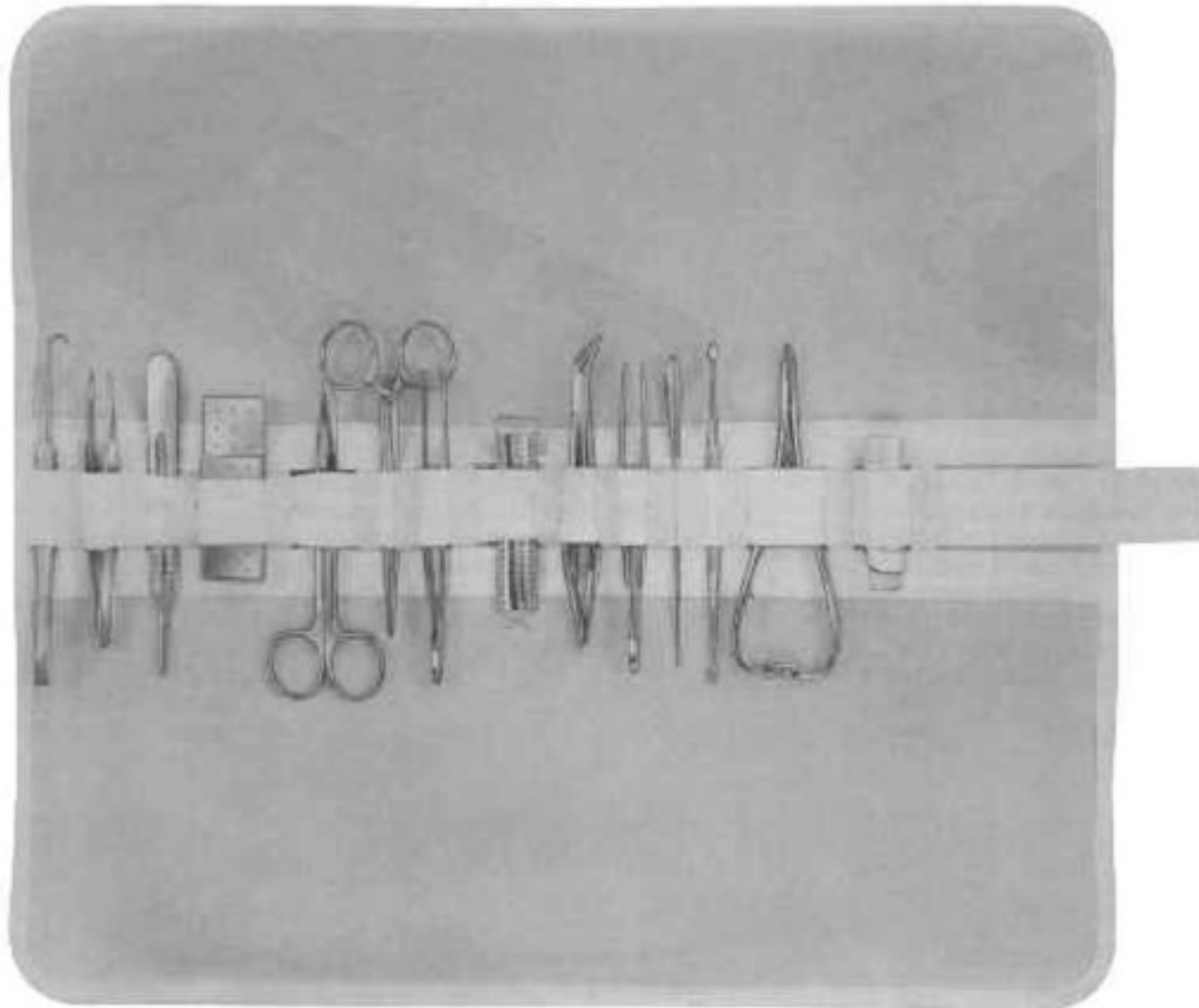

07-293

Pocket instrument set in metal case 170 x 90mm with sterilizable canvas roll consisting of:

- 1 Myrtle leaf probe, 130mm
- 1 Sharp double curette
- 1 FEILCHENFELD splinter forceps, 115mm
- 1 Dissecting forceps, 130mm
- 1 Tissue forceps, 130mm

- 1 Straight surgical scissors, 130mm
- 1 Scalpel handle no. 4
- 1 Perforated metal case, consisting of 6 scalpel blades BB 520
- 1 KOCHER haemostatic forceps, 130mm
- 1 Skin hook
- 1 MATHIEU needle holder, 140mm
- 1 Tube of suture skin, sterile in alcohol
- 1 MICHEL clip forceps, 120mm

- 25 MICHEL clip, 16 x 3mm
- 1 Perforated metal case, stainless, consisting of:
- 1 Suture needle
- 1 item
- 1 item



07-294

Venae sectio set, in sterilizable canvas roll consisting of:

- 1 Tissue forceps, 1 x 2 teeth, 140mm
- 1 Dissecting forceps, 145mm
- 1 FEILCHENFELD straight scissors, sharp, 110mm
- 1 curved scissors, blunt, 115mm
- 1 HALSTED mosquito forceps, curved on flat, 125mm

- 1 DESCHAMPS needle, blunt, 210mm
- 1 DOYEN Director, curved, 140mm
- 2 Wound retractors, 4 blunt prongs, 160mm
- 2 DESMARRES wound retractors, 135mm
- 1 FINSSEN retractors, 2 x3 blunt prongs, 80mm

- 1 Scalpel handle no. 4
- 4 Sterile scalpel blades, no 18, single peel pack
- 1 Needle box, perforated, round, diam. 65mm
- 1 HEGAR-MAYO DUROGRIP needle holder, 180mm



07-295

Venae sectio set, in metal case
consisting of:

Bottom tray

- 1 MATHIEU needle holder, fine pattern 140mm
- 1 Ligature needle, fine short pattern
- 1 DOYEN director, curved
- 1 HEGENBARTH clip forceps,
- 1 ELSCHNIG tissue forceps, 1 x 2 teeth fine, 150mm
- 1 Dressing forceps, fine 105mm
- 1 Tissue forceps, 1 x 2 teeth, 110mm
- 1 Vessel scissors, straight, with 1 ball point, 110mm
- 1 Vessel scissors, curved, pointed 105mm
- 1 FINSEN retractor
- 1 Perforated needle case

Top tray

- 1 Scalpel, pointed
- 1 Scalpel, bellied
- 2 HALSTED mosquito forceps, curved, 125mm
- 2 HALSTED mosquito forceps, straight, 1x 2 teeth, 125mm
- 3 BACKHAUS towel forceps, 90mm
- 2 Flacon holder

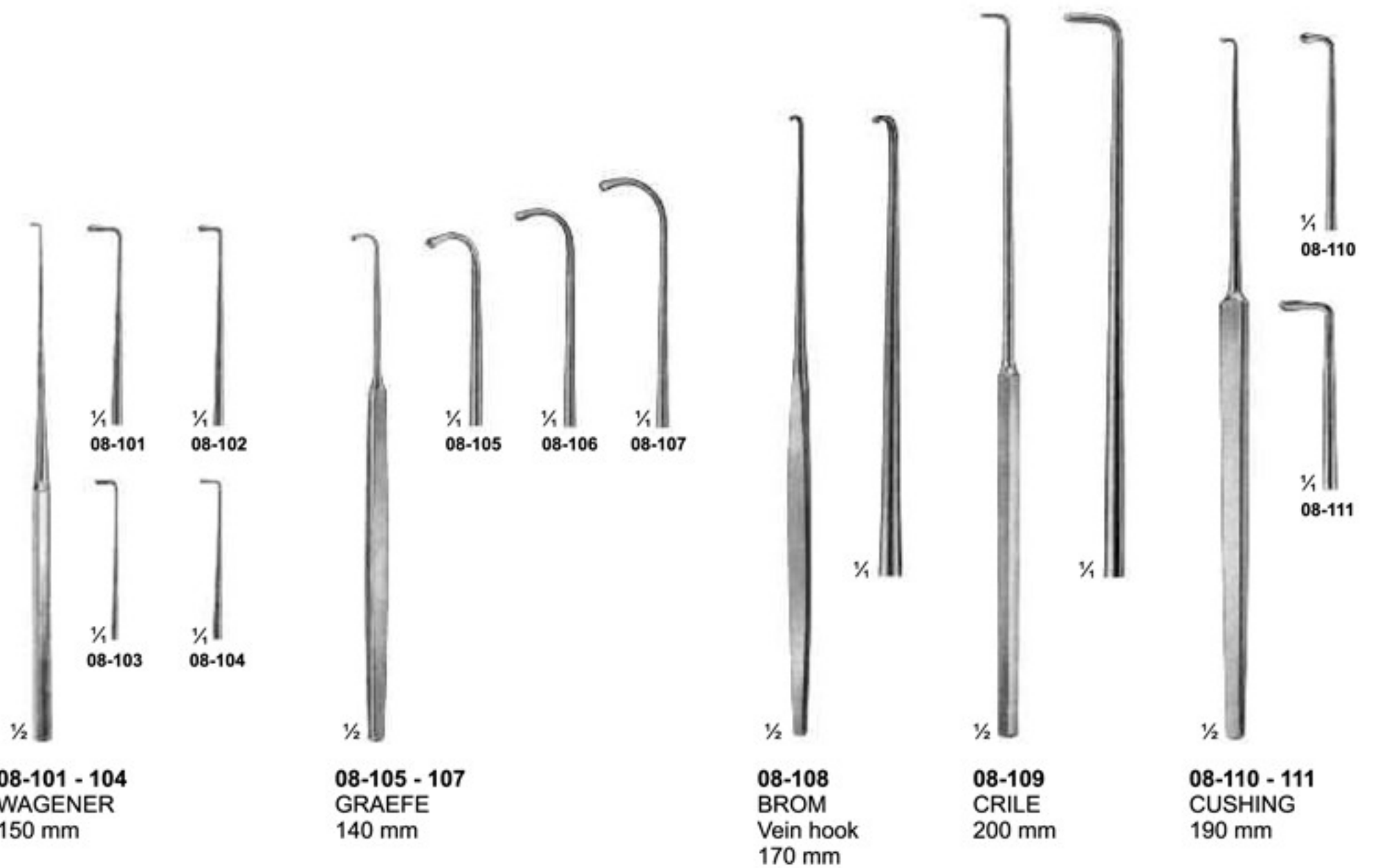

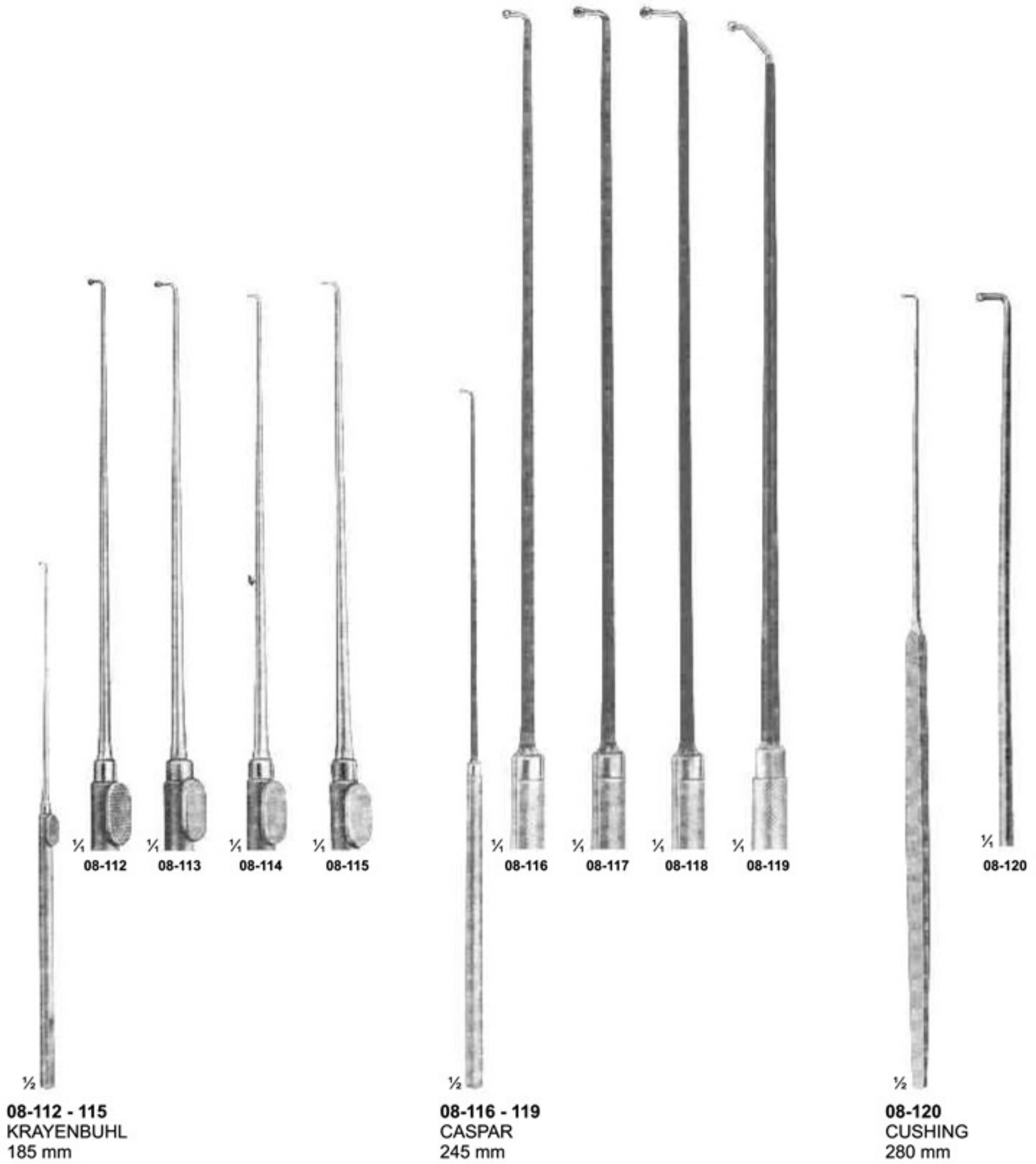

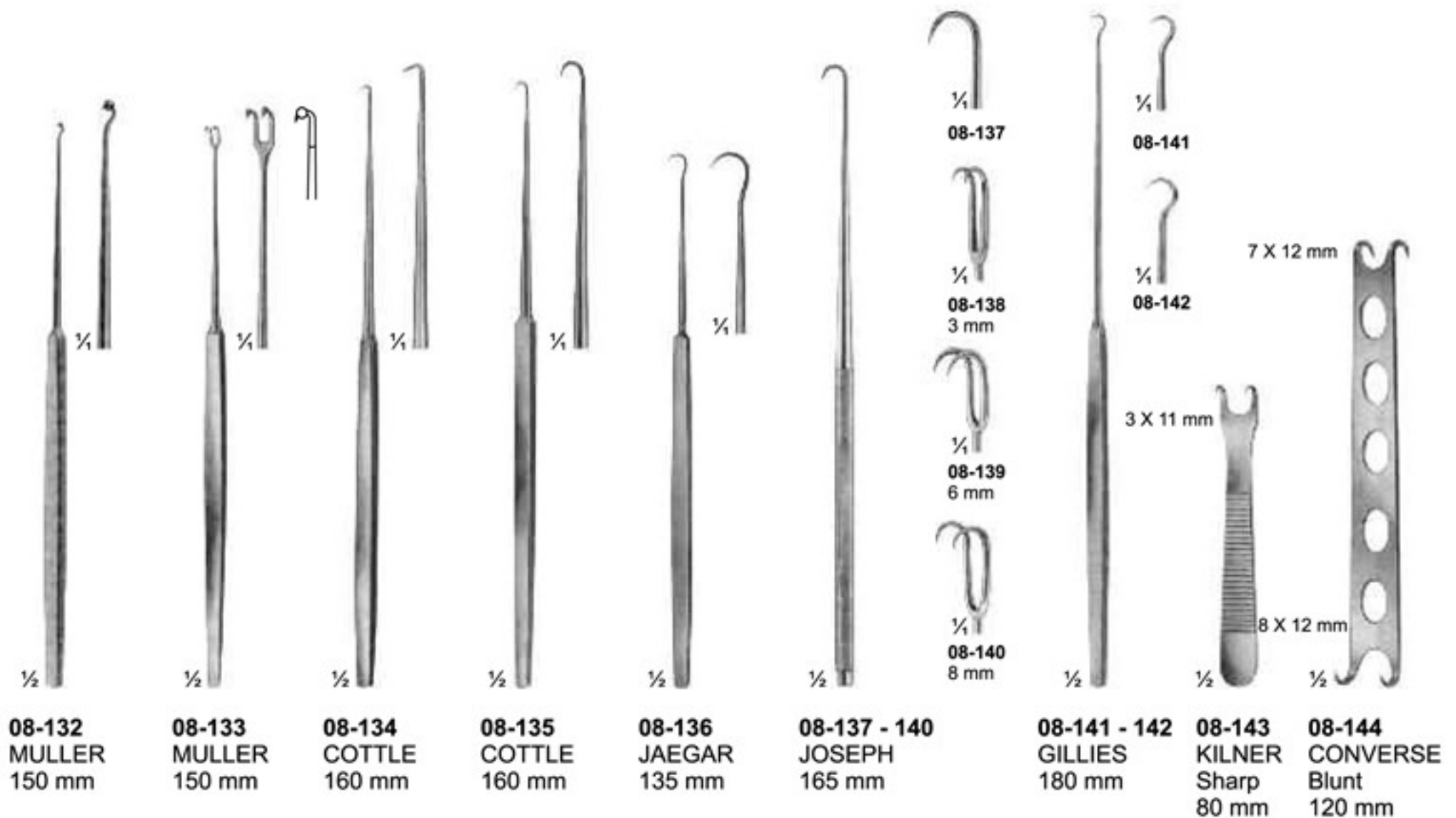
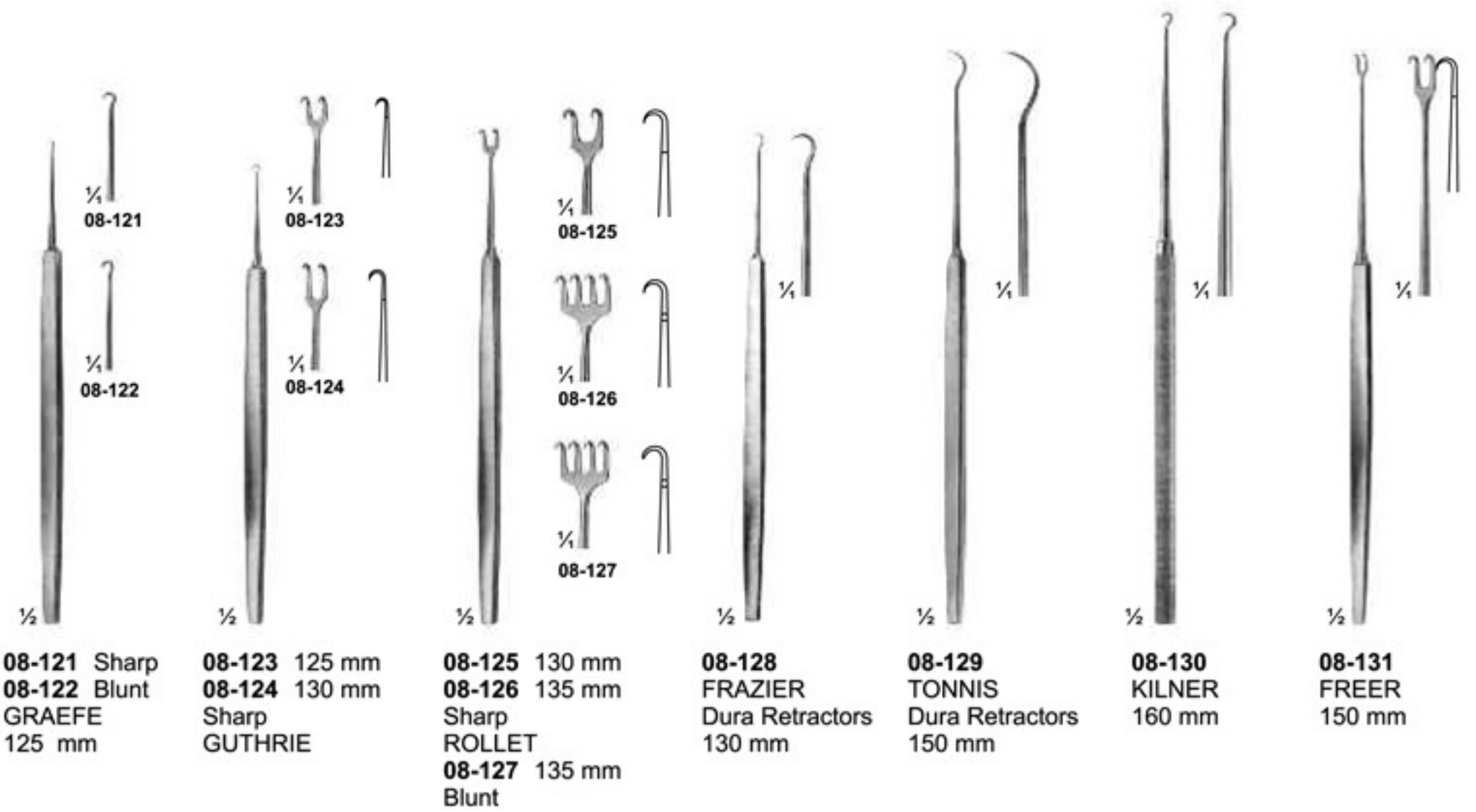



08-145
BERGMANN
140 mm

08-146
BOSE
165 mm

08-147
BOSE
165 mm

08-148 - 150
180 mm

08-151 - 153
Flexible shaft, sharp
155 mm

08-154 - 156
Flexible shaft, blunt
155 mm

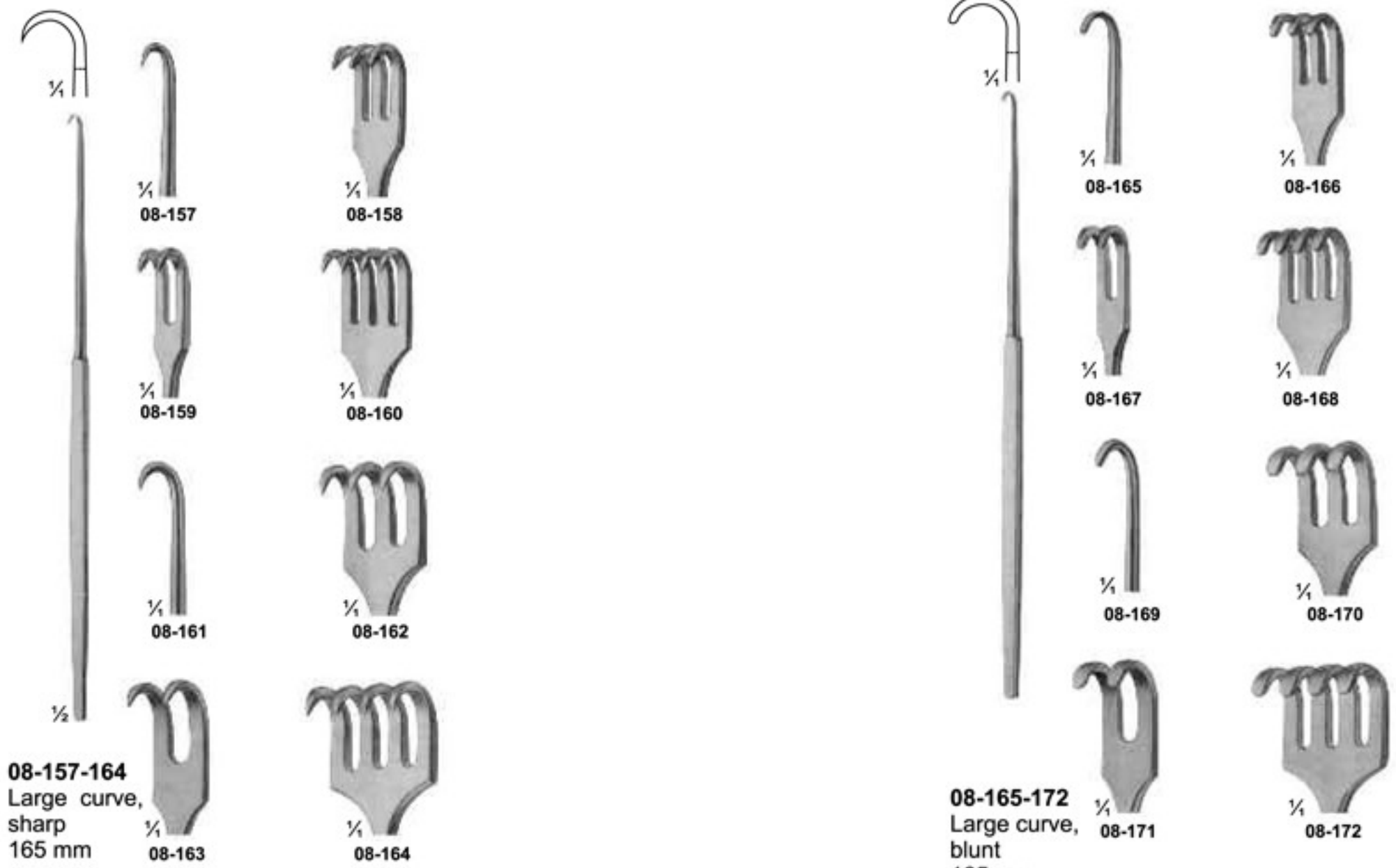

08-157-164
Large curve, sharp
165 mm

08-165-172
Large curve, blunt
165 mm

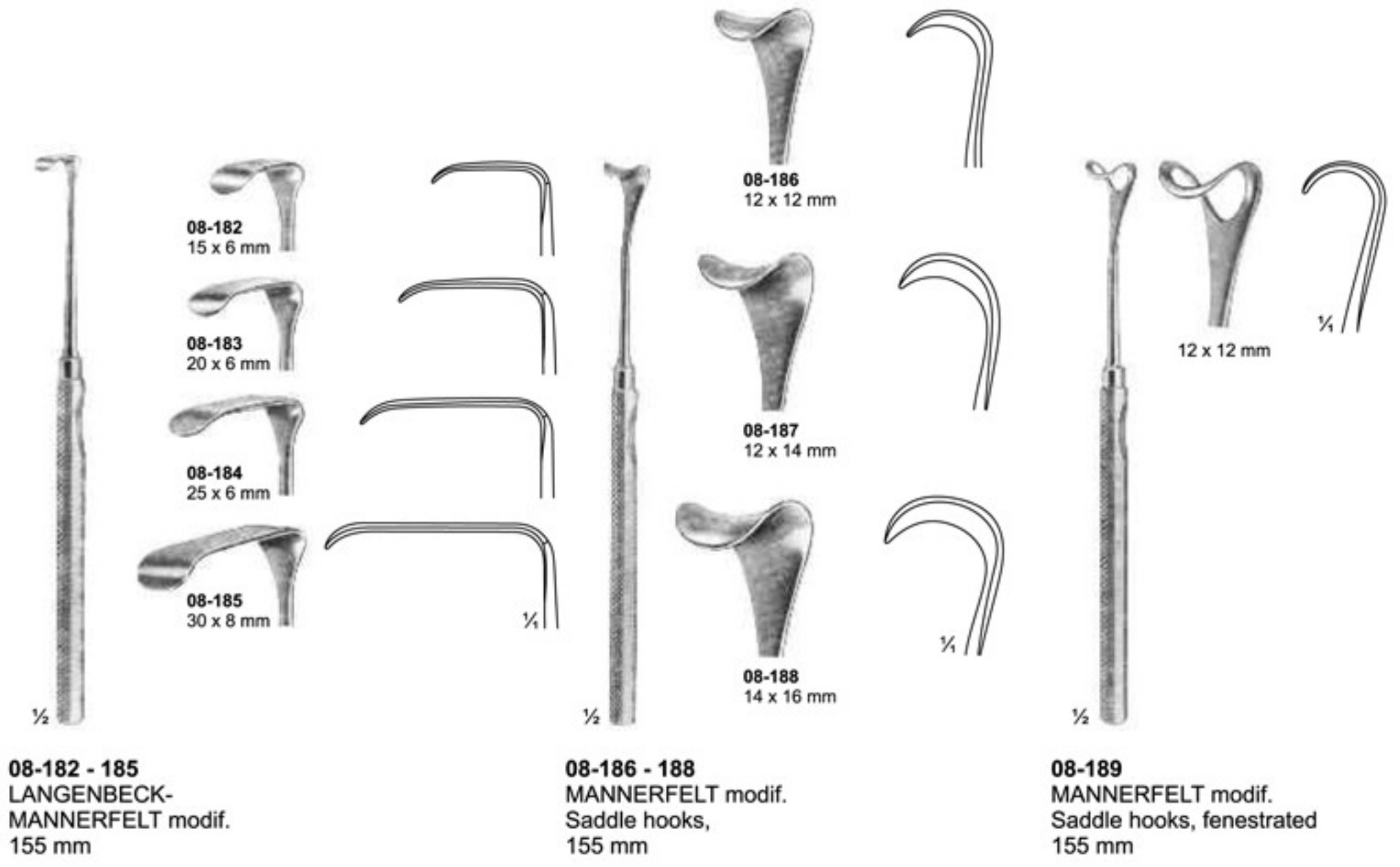
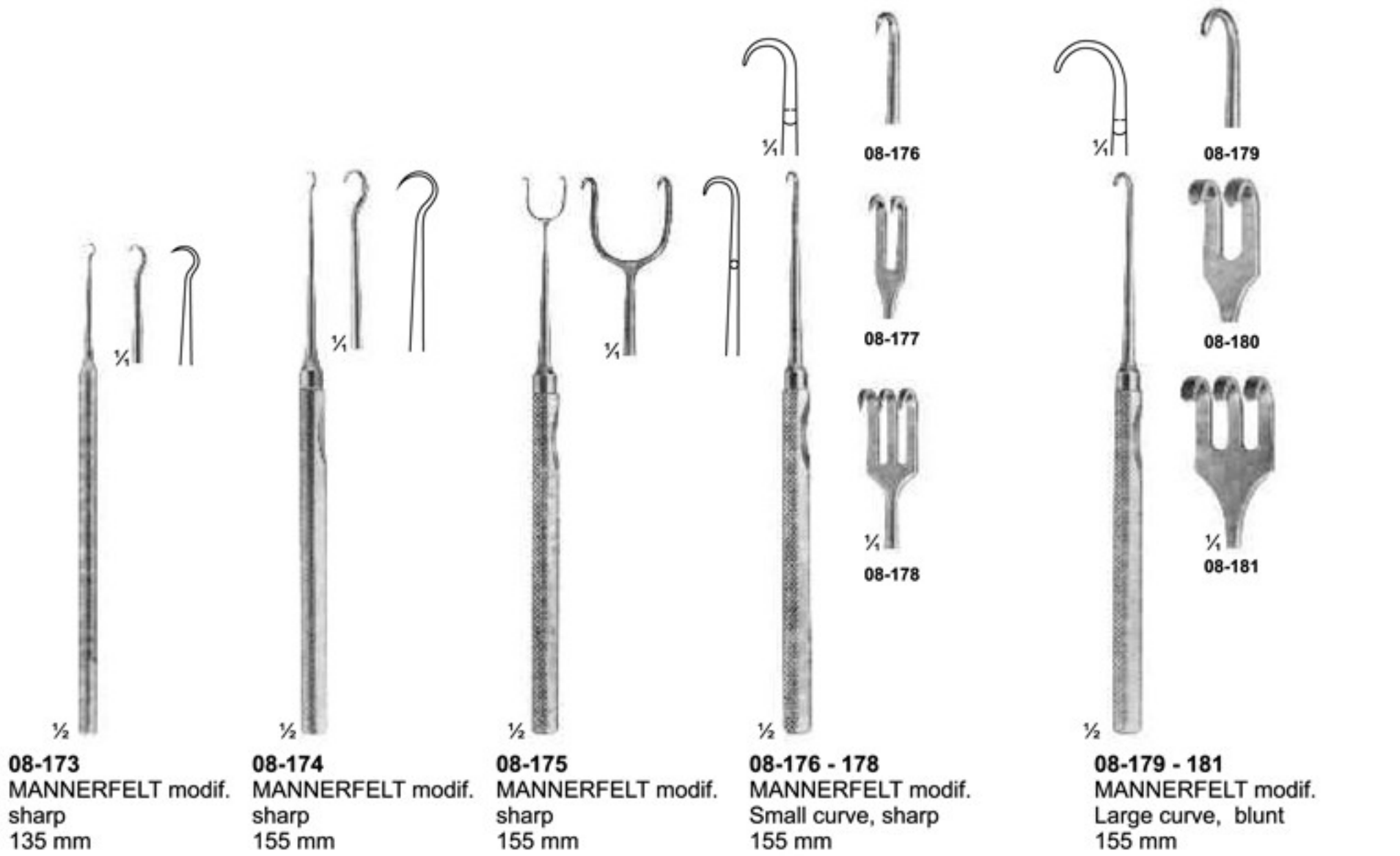

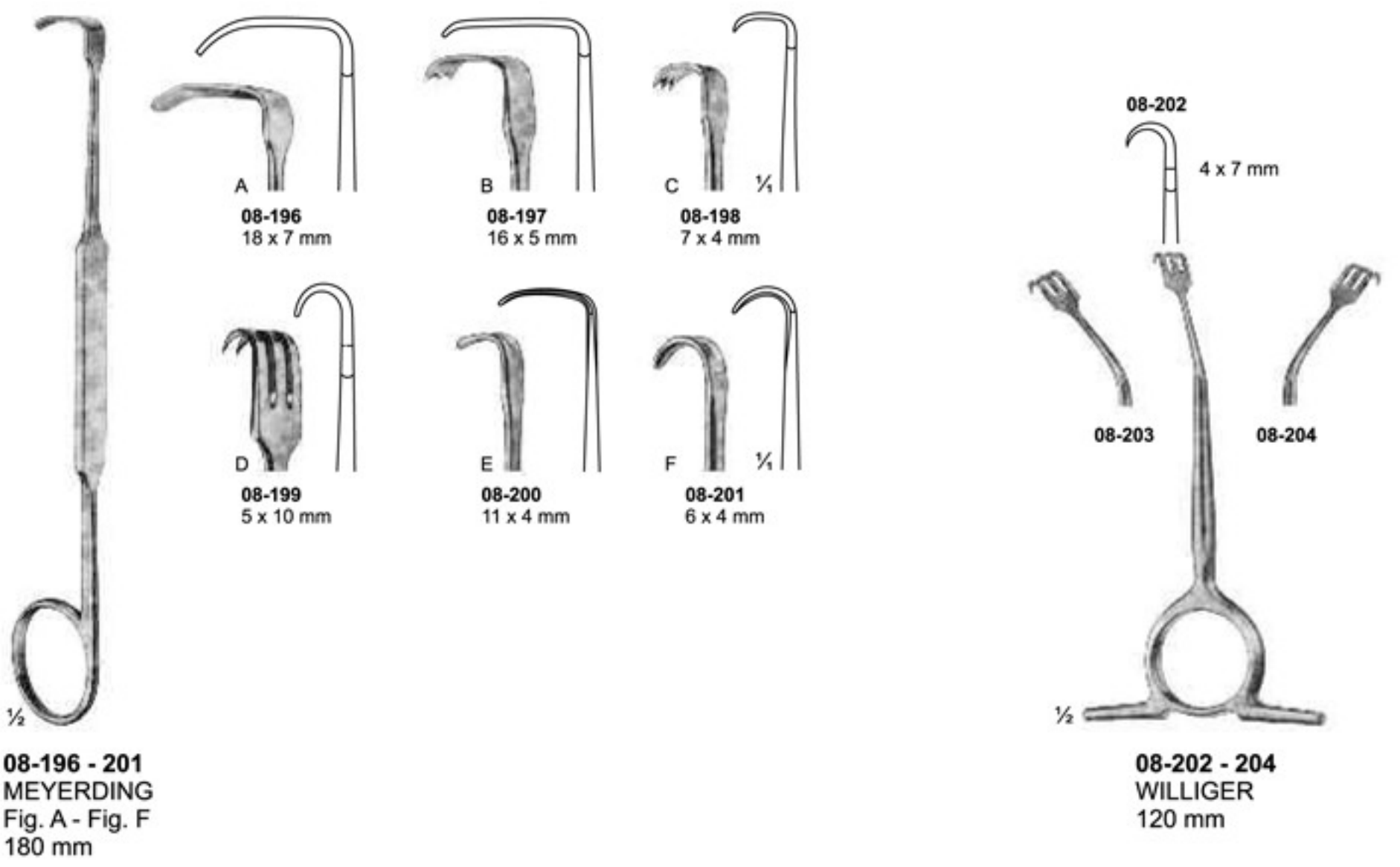



08-205
EMMET
Fistula hook
220 mm



08-206
SIMON
Fistula hook
220 mm

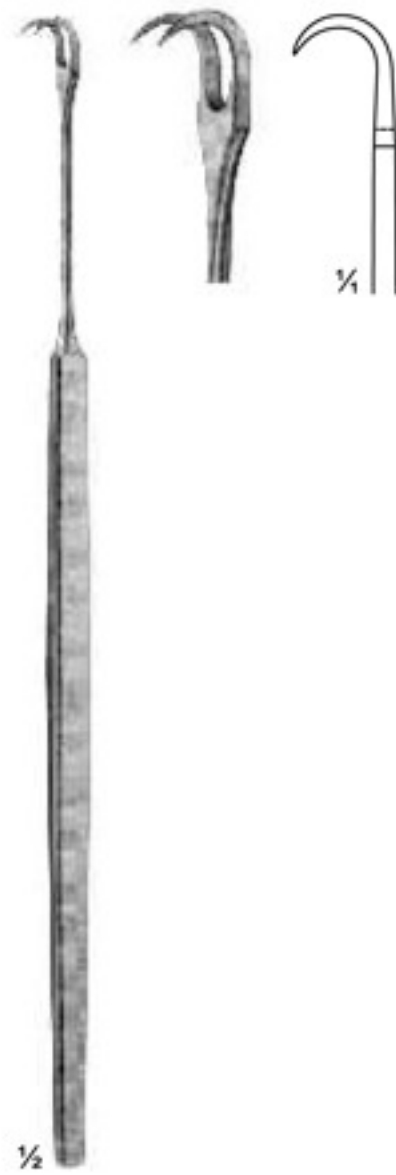

08-207
SIMON
Fistula hook
220 mm



08-208
LANGE
Fistula hook
230 mm

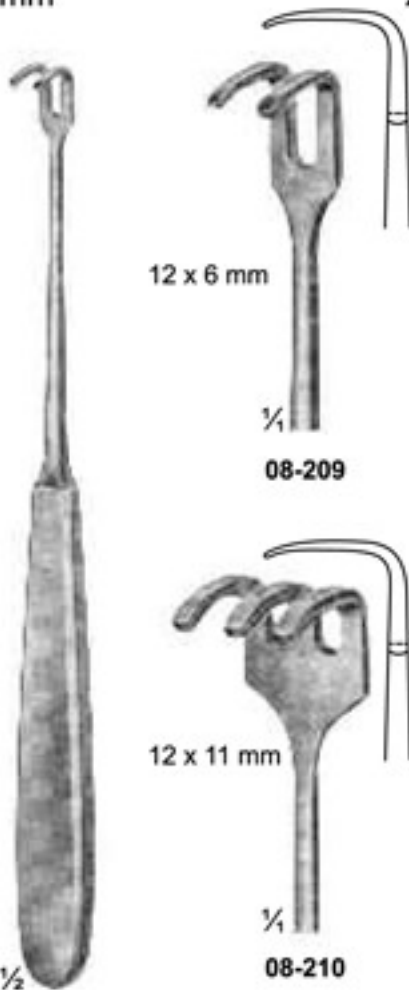

08-209 - 210
Tendon hooks
175 mm

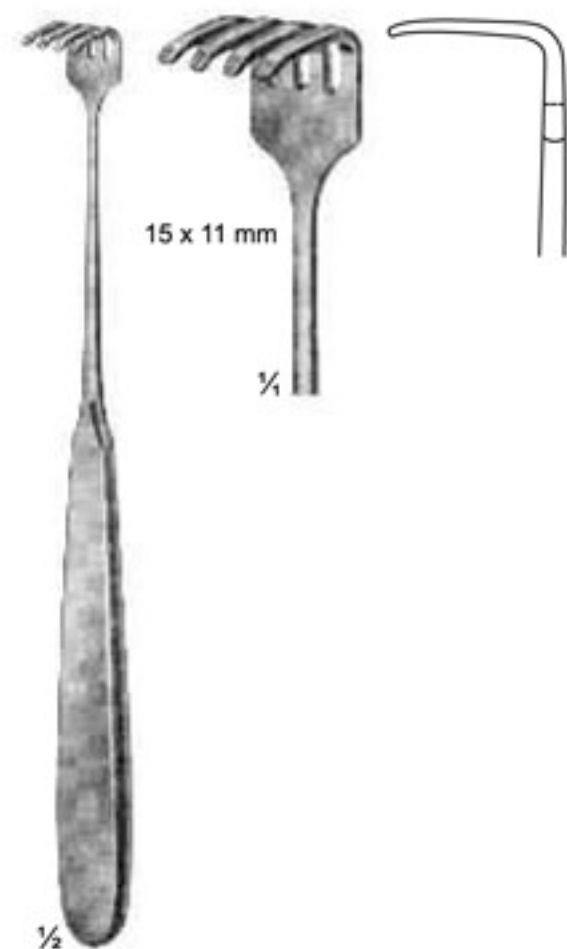

08-211
KLAPP
Tendon hooks
175 mm

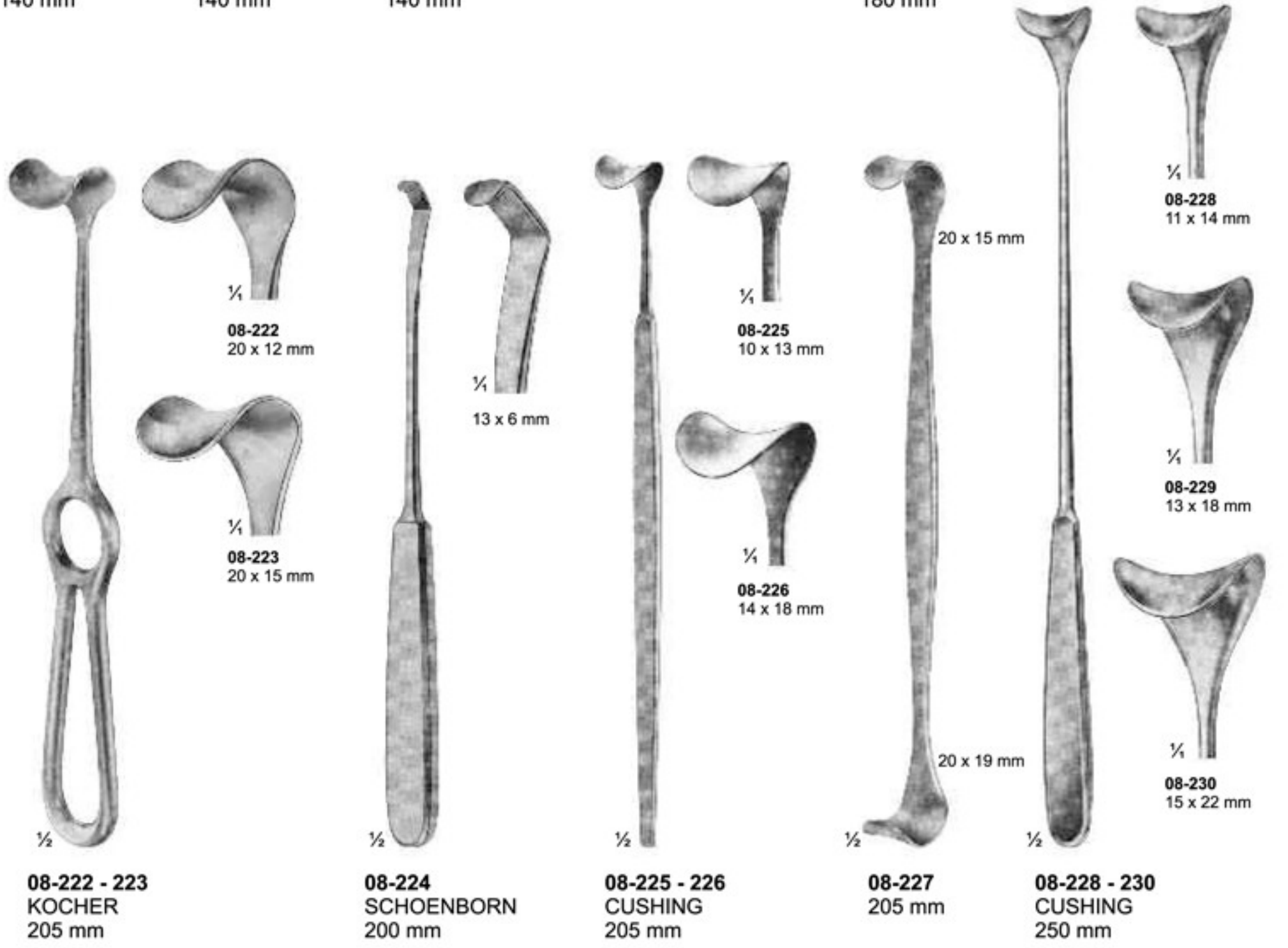

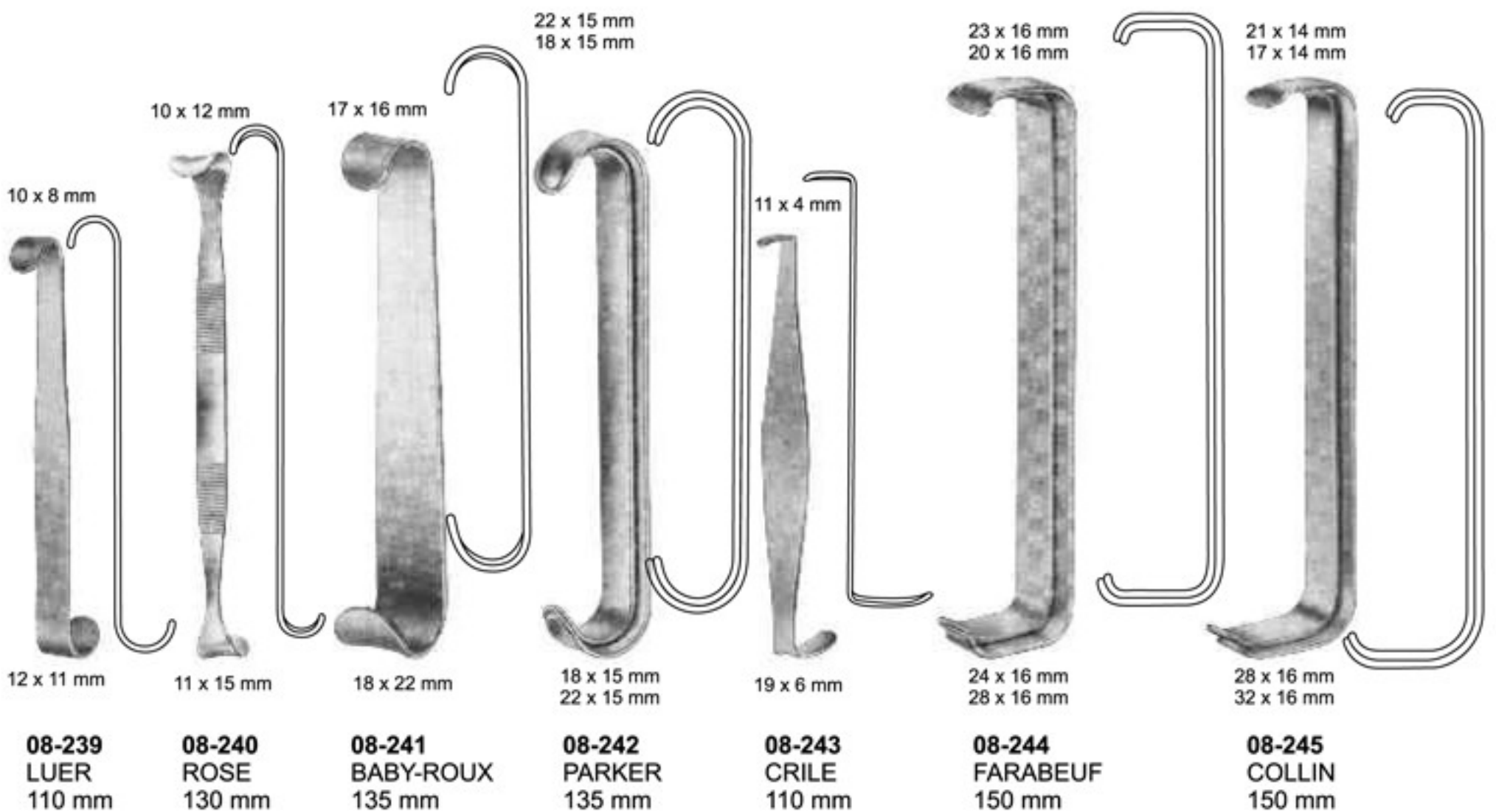

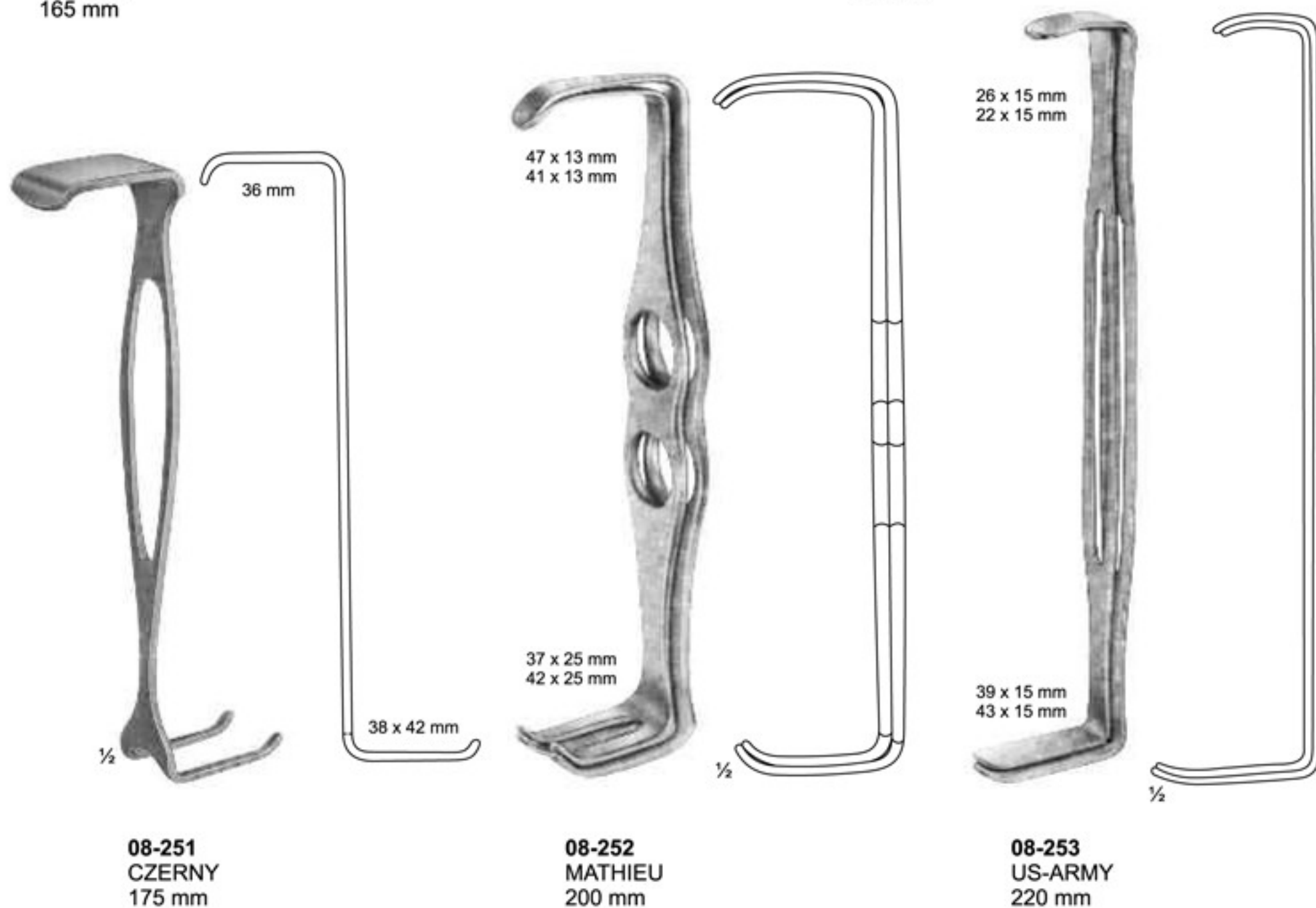
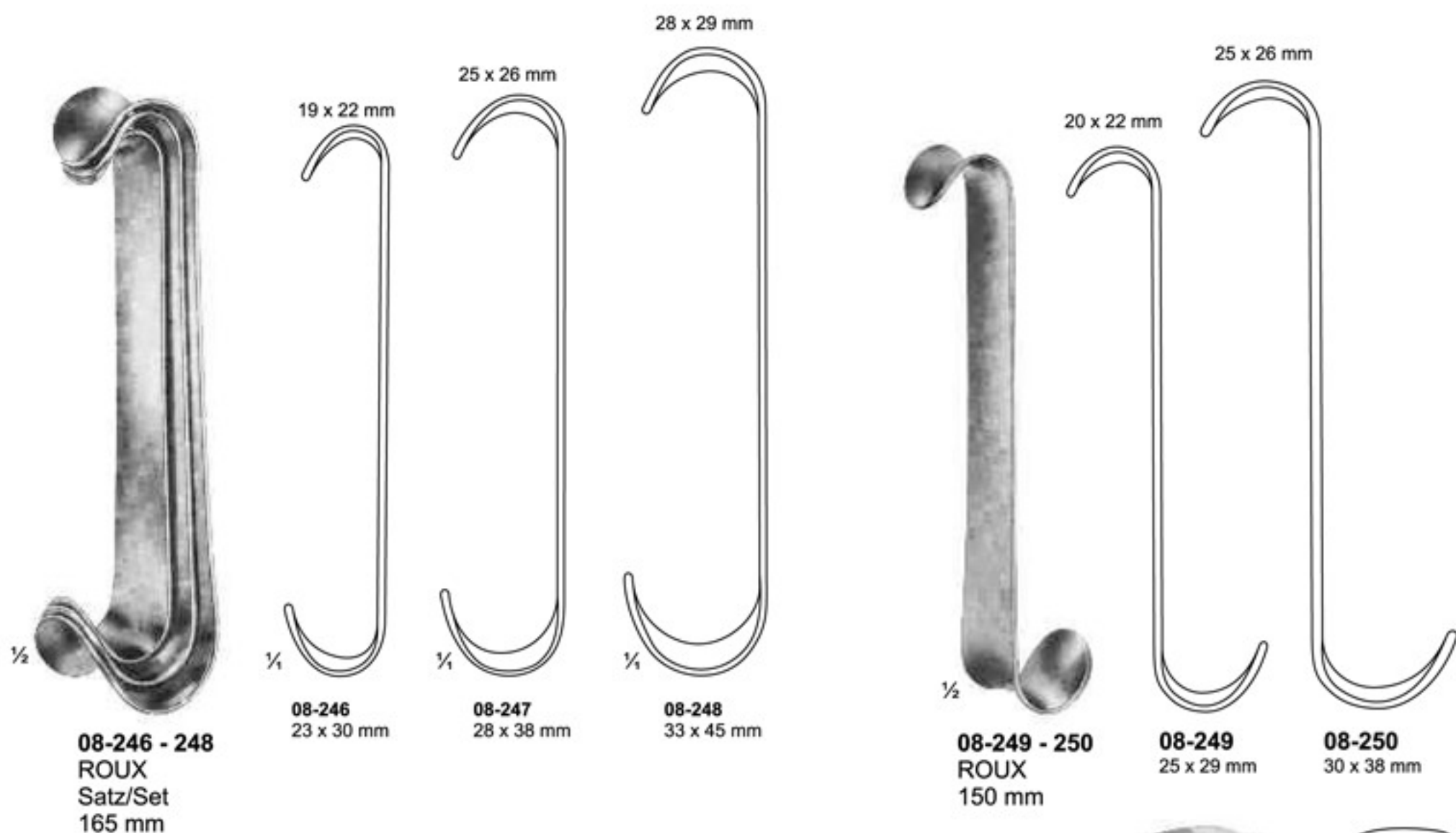



08-254
KOCHER
Sharp
205 mm



08-255
KOCHER
Sharp
220 mm



08-256
KOCHER
Blunt
220 mm



08-257
VOLKMANN
Sharp
220 mm



08-258
VOLKMANN
Sharp
220 mm



08-259 - 266
VOLKMANN
225 mm

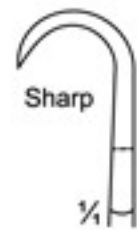

Sharp



08-259
9 x 8 mm



08-260
9 x 13 mm



08-261
9 x 19 mm



08-262
9 x 29 mm

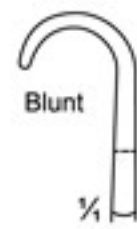

Blunt



08-263
8,5 x 8 mm



08-264
8,5 x 13 mm



08-265
8,5 x 19 mm



08-266
8,5 x 29 mm

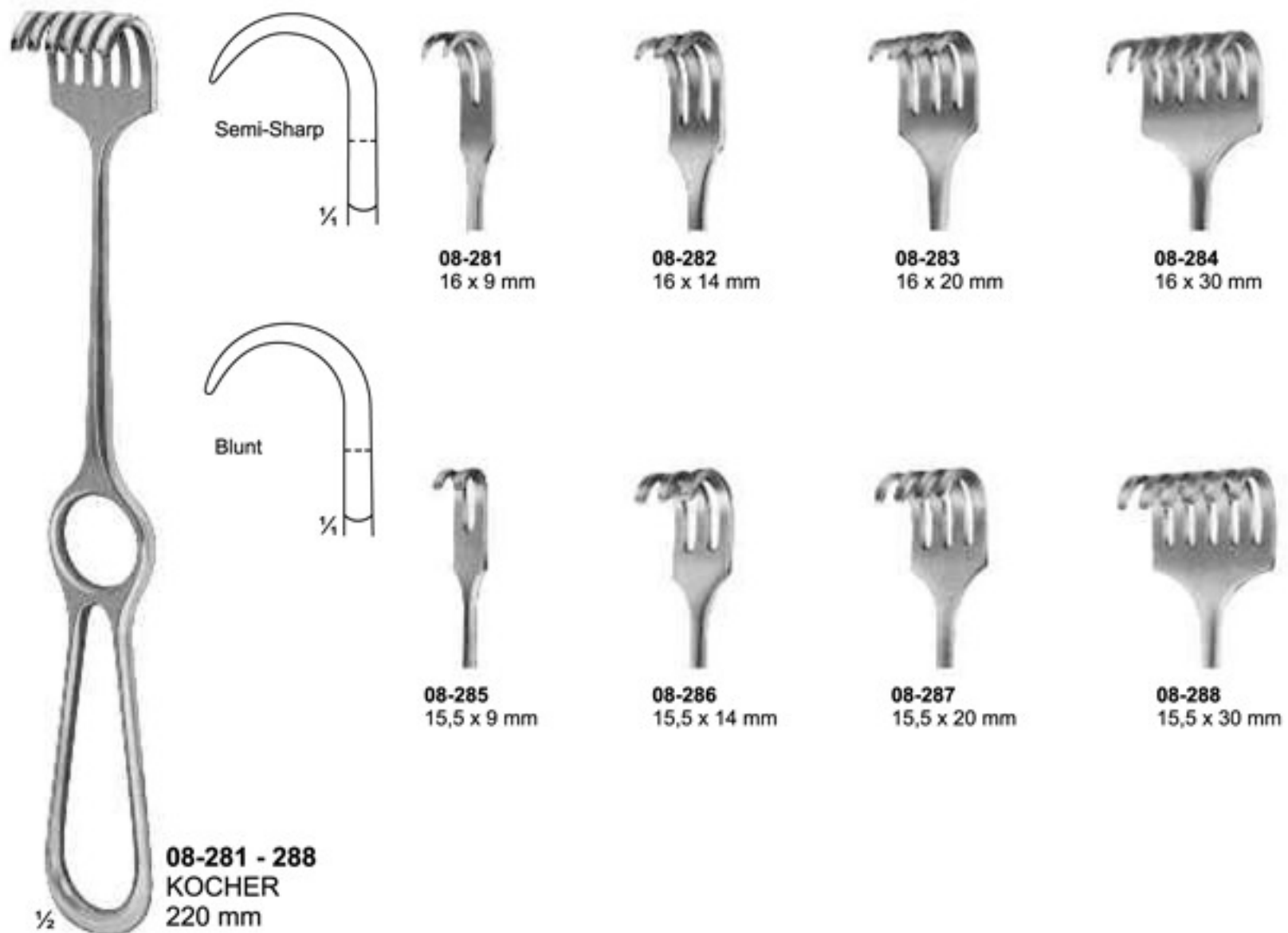
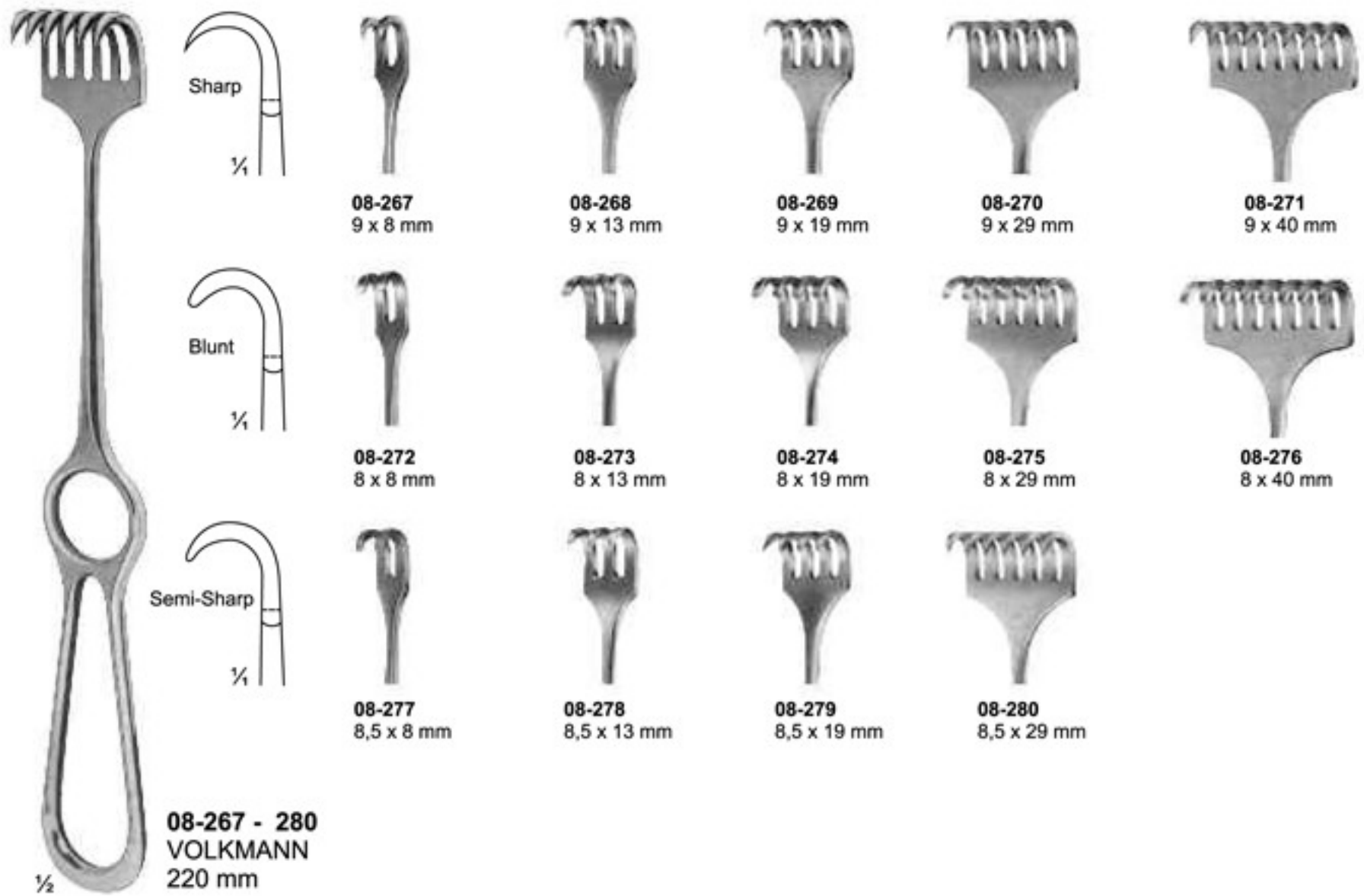

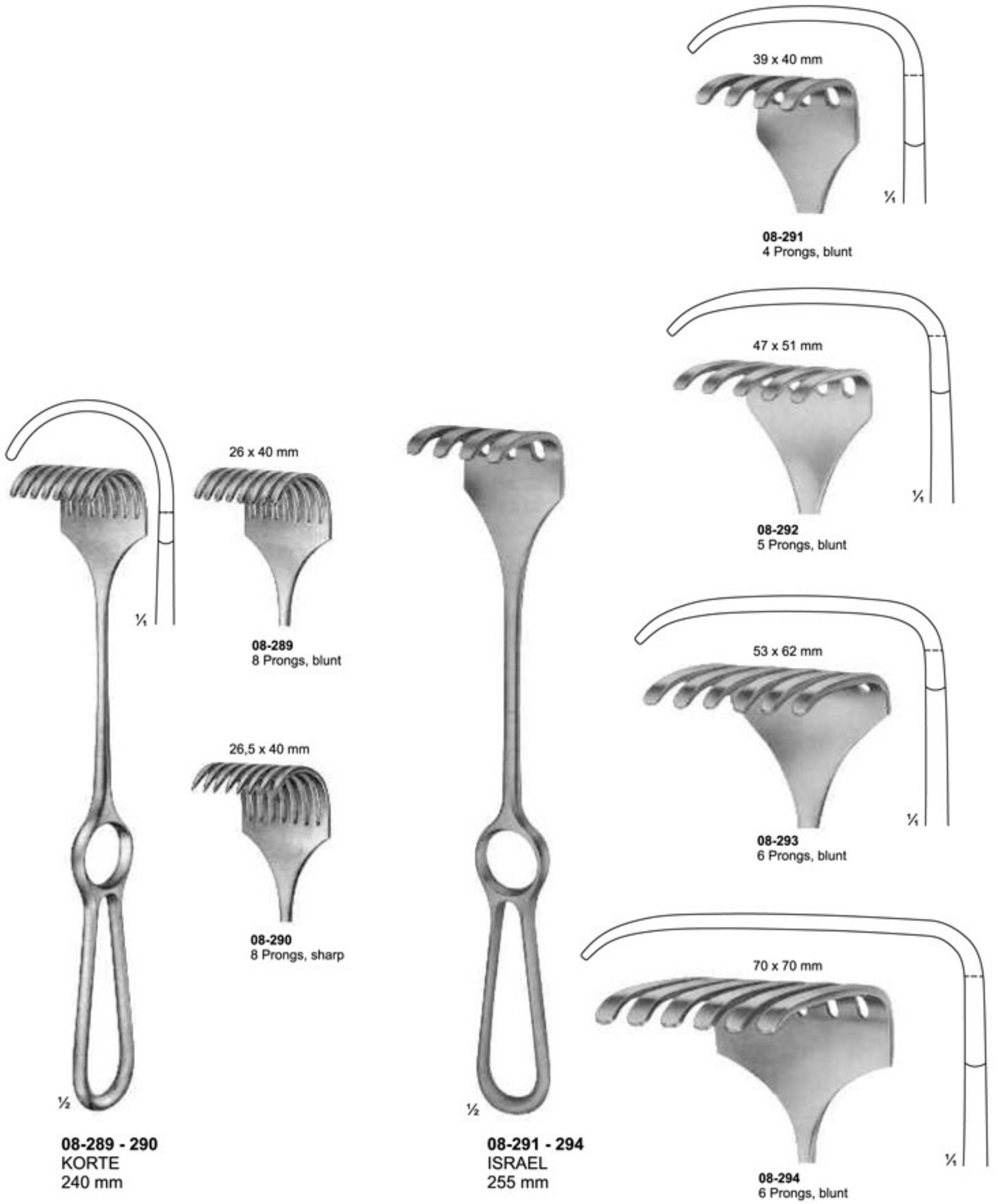

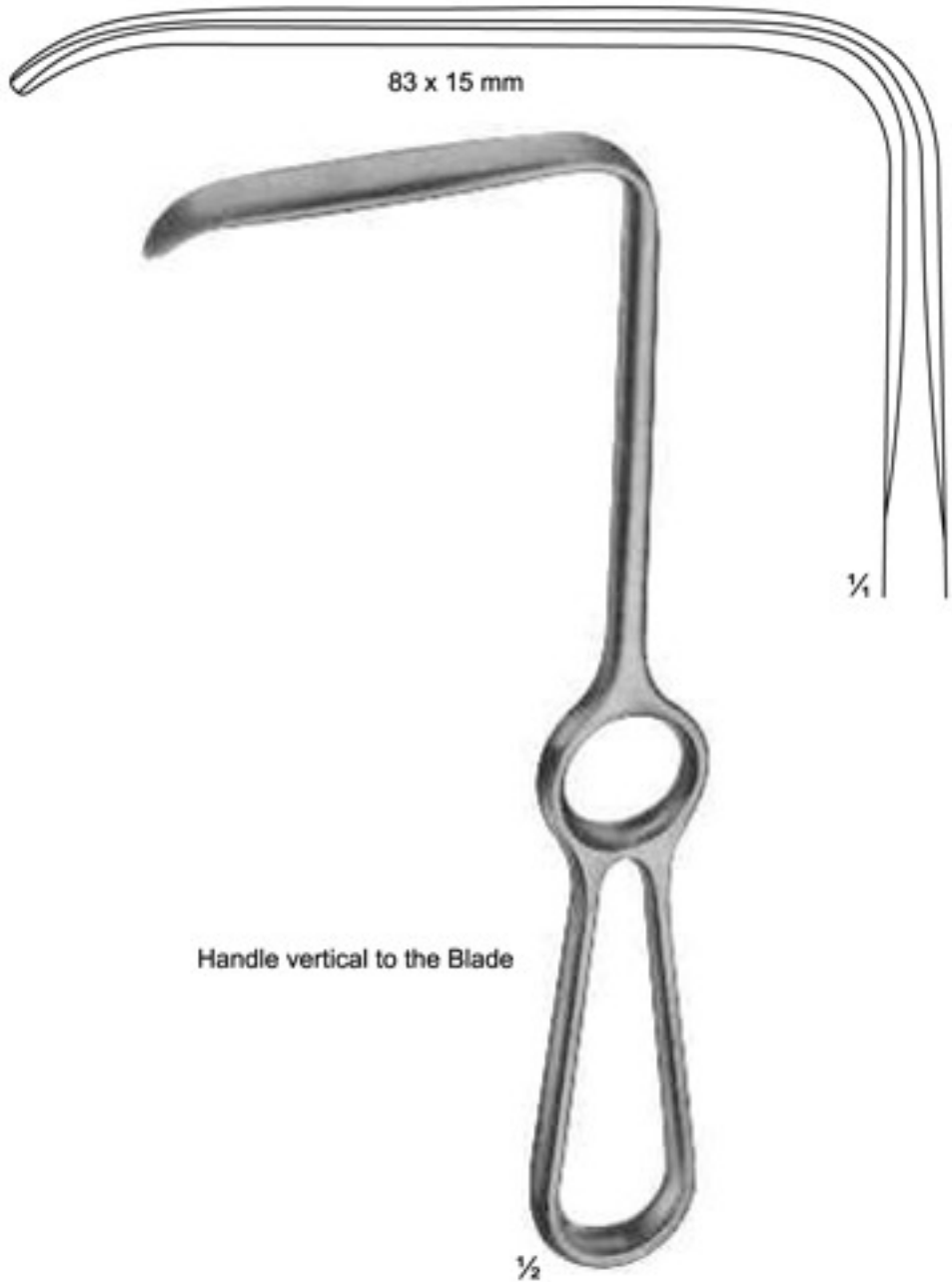

08-295 - 300
LANGENBECK
 210 mm
08-295 28 x 10 mm
08-296 28 x 14 mm
08-297 33 x 14 mm
08-298 28 x 16 mm
08-299 40 x 10 mm
08-300 40 x 13 mm

08-301 - 307
KOCHER-LANGENBECK
 215 mm
08-301 25 x 6 mm
08-302 35 x 8 mm
08-303 35 x 11 mm
08-304 35 x 15 mm
08-305 41 x 11 mm
08-306 55 x 11 mm
08-307 70 x 14 mm

08-308
LANGENBECK
 215 mm



08-309 - 313
KOCHER
230 mm



08-314 - 316
SAUERBRUCH
225 mm

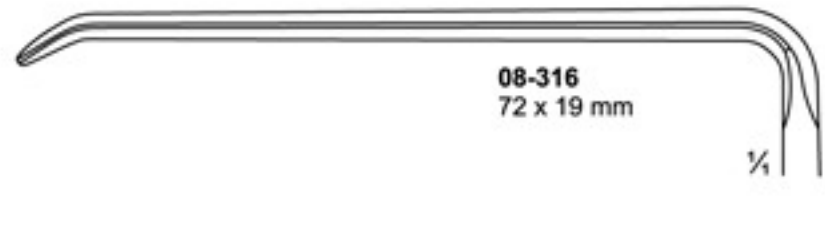
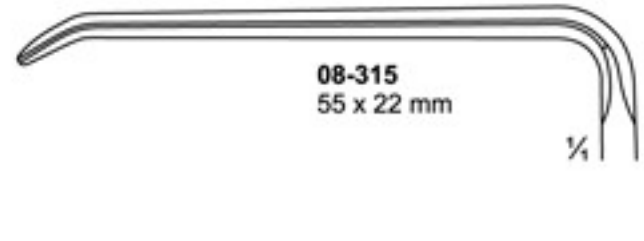
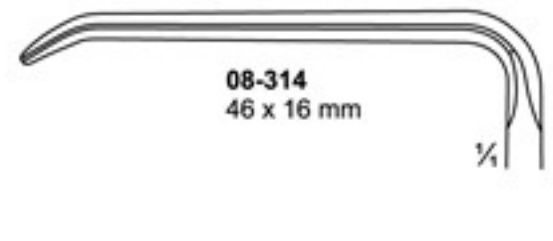
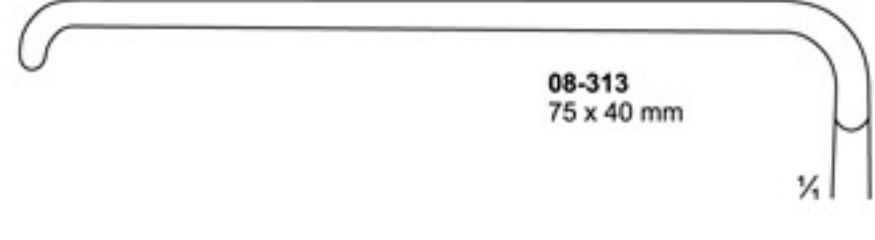
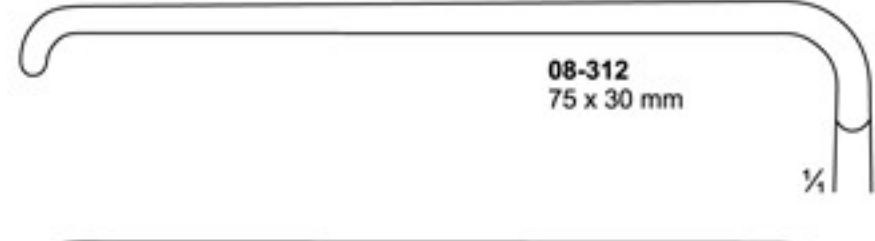
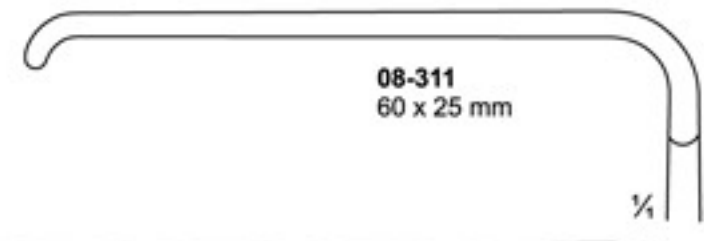
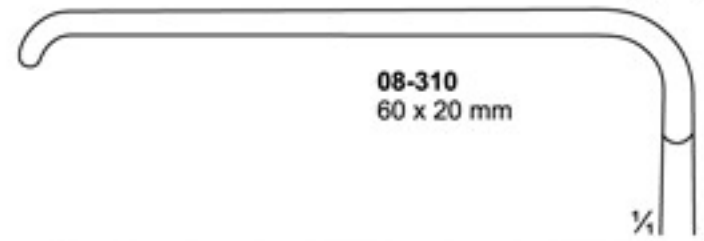
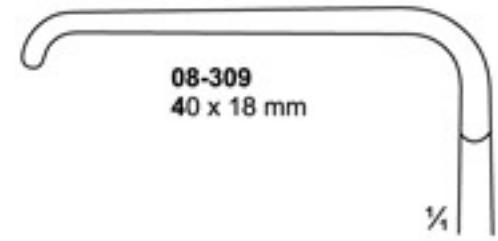



08-317 - 319
MIDDELDORPF



08-317
15 x 15 mm
220 mm



1/4



08-318
20 x 22 mm
215 mm

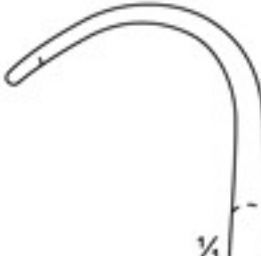

1/4



08-319
28 x 28 mm
235 mm

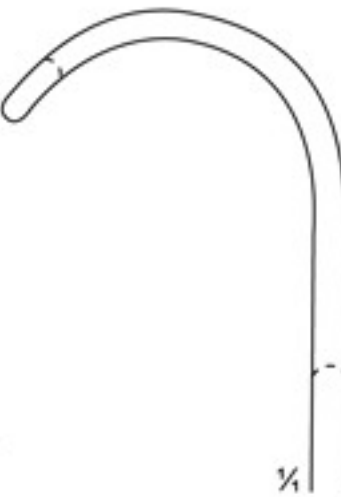

1/4



08-320
BUCHS
205 mm



38 x 18 mm

1/4



08-322
KOCHER
230 mm

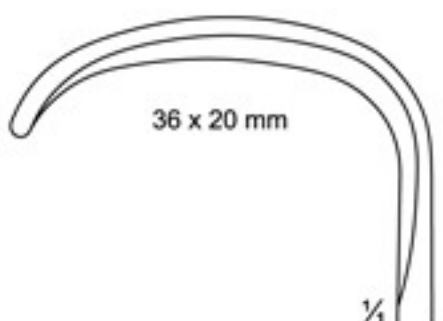

36 x 20 mm

1/4



08-321
CASPAR
210 mm

67 x 17 mm

1/4



$\frac{1}{2}$
08-323 - 328
HOSEL
250 mm

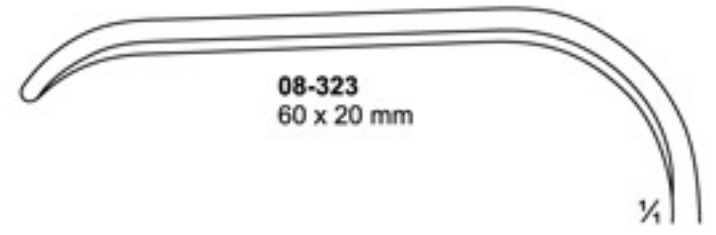

08-323
60 x 20 mm

$\frac{1}{4}$

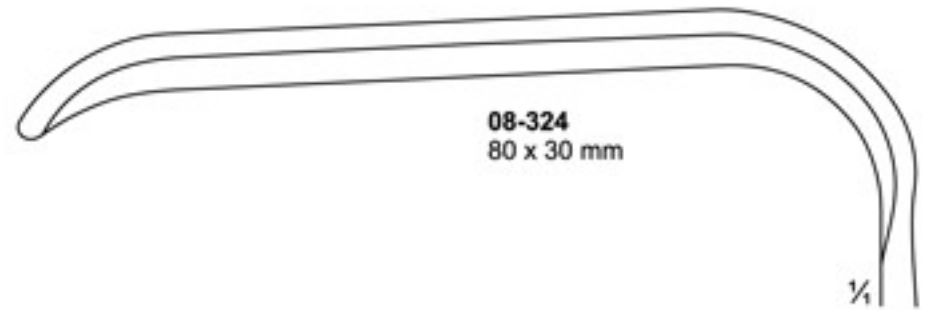

08-324
80 x 30 mm

$\frac{1}{4}$

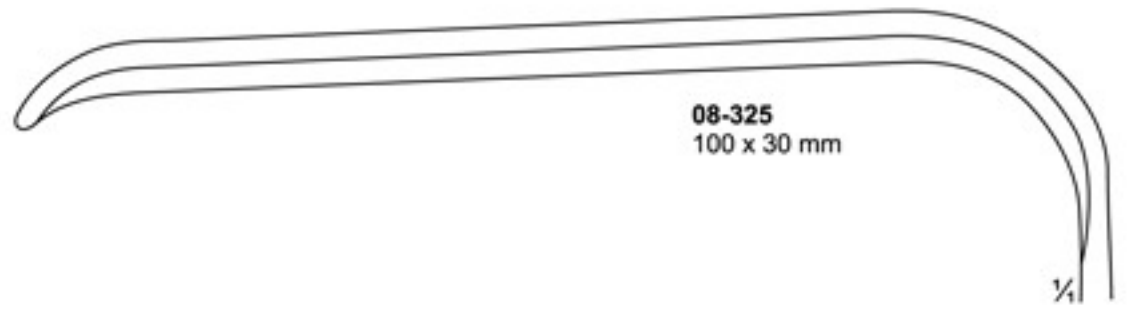

08-325
100 x 30 mm

$\frac{1}{4}$

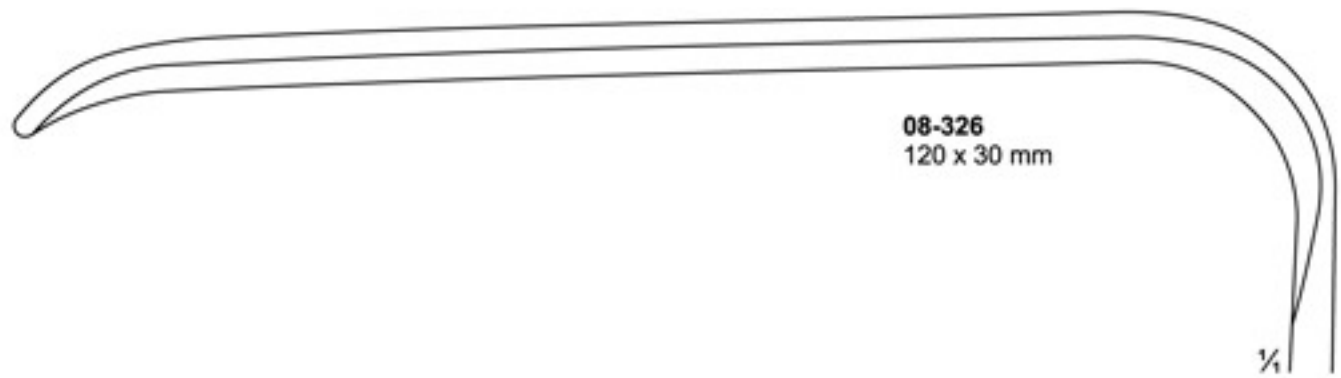

08-326
120 x 30 mm

$\frac{1}{4}$

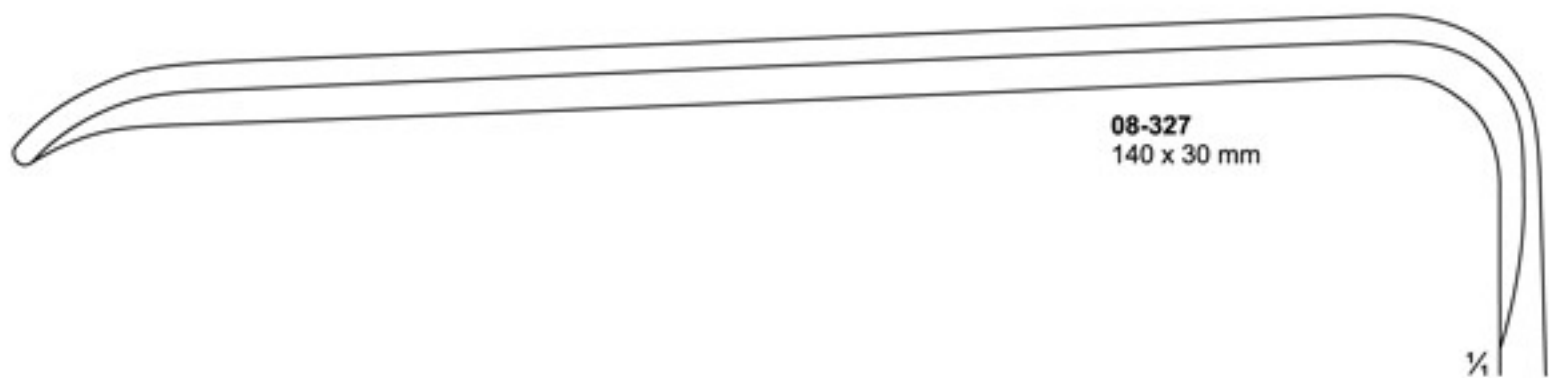

08-327
140 x 30 mm

$\frac{1}{4}$

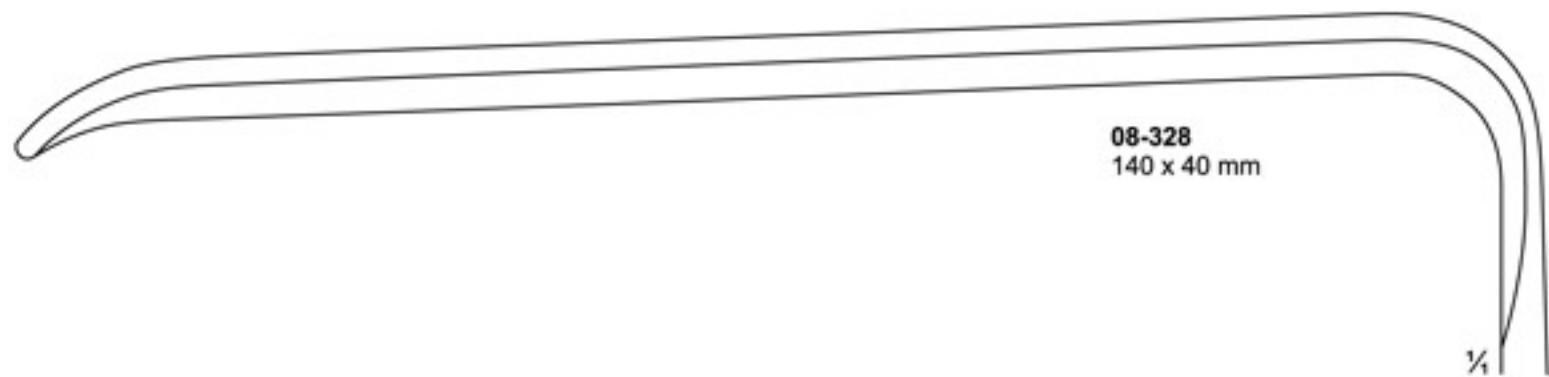

08-328
140 x 40 mm

$\frac{1}{4}$

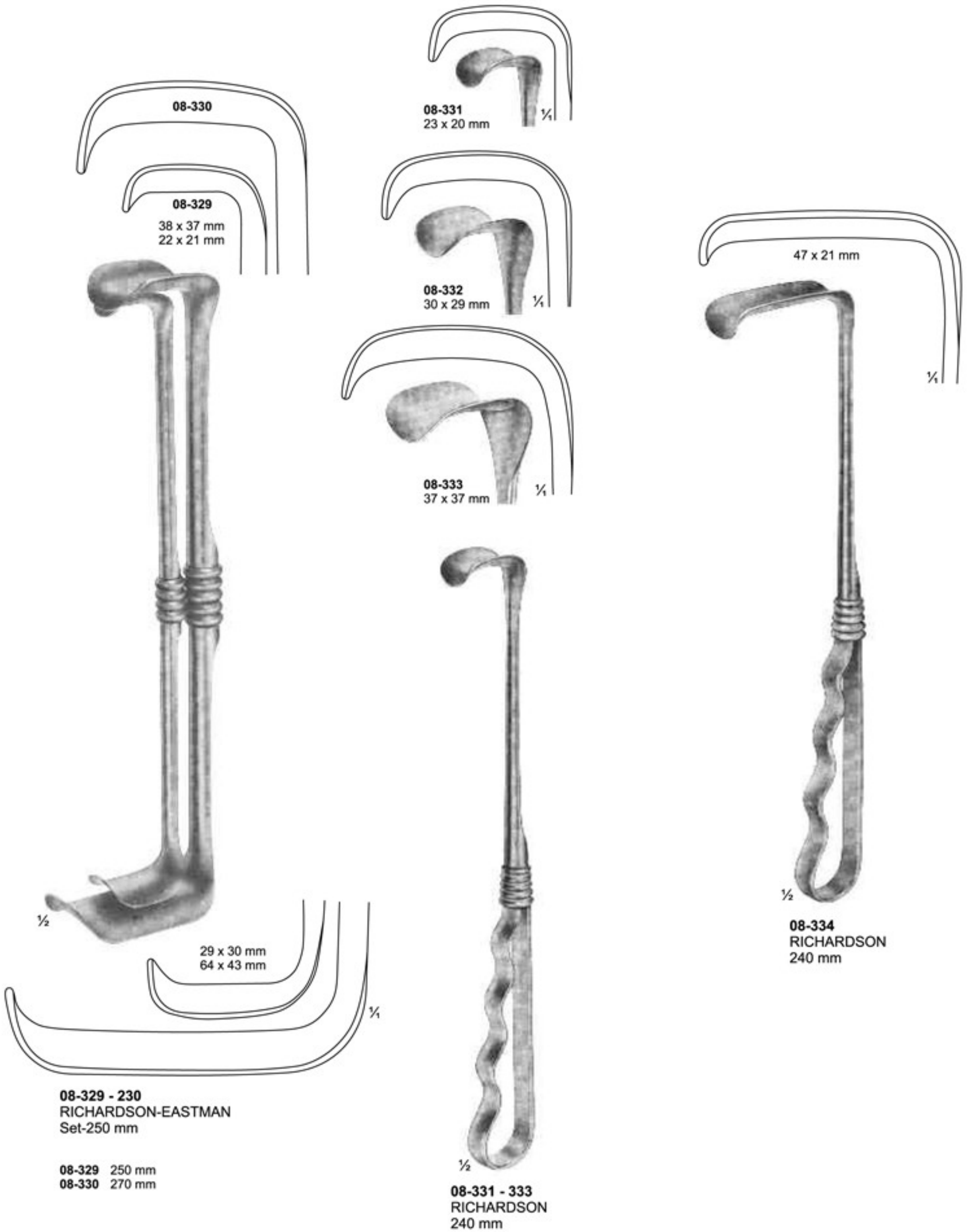

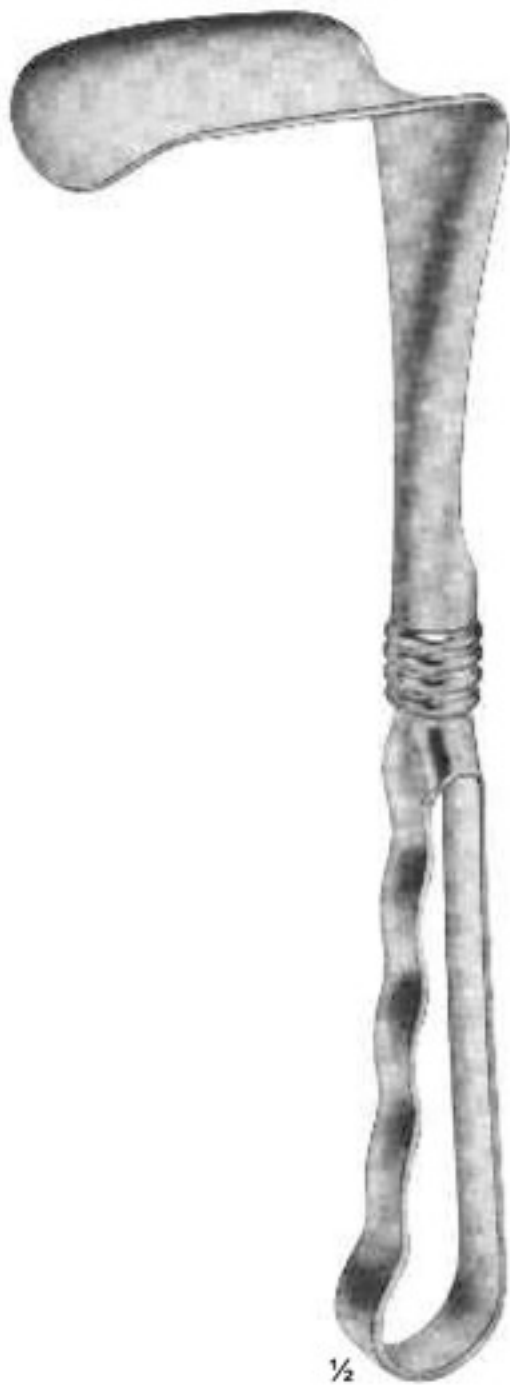
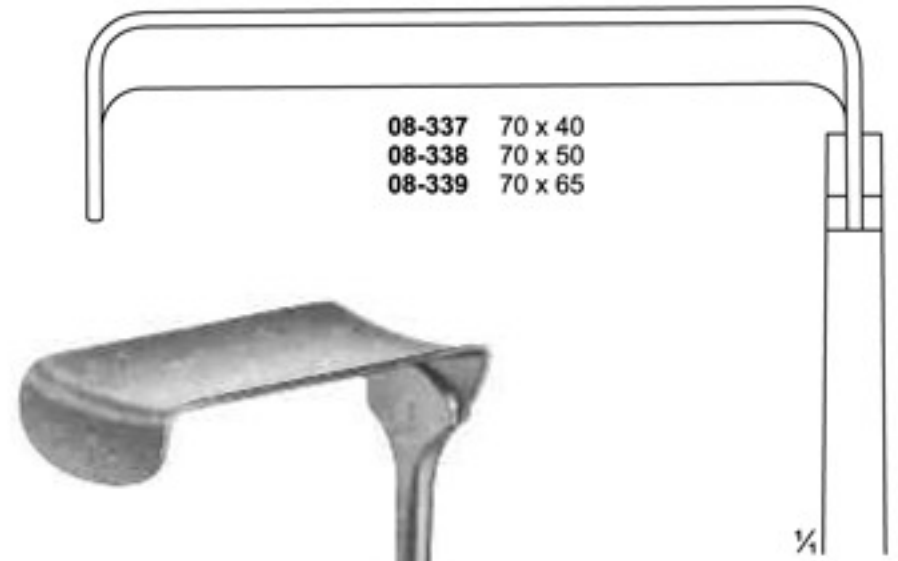
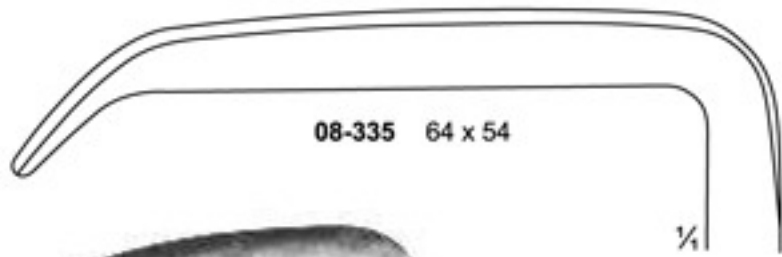
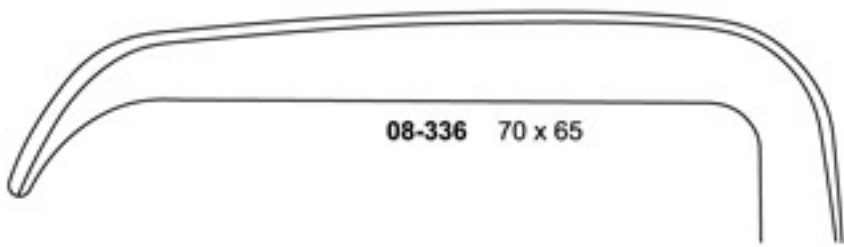

½
08-335 - 336
KELLY
260 mm



½
08-337 - 339
MORRIS
245 mm

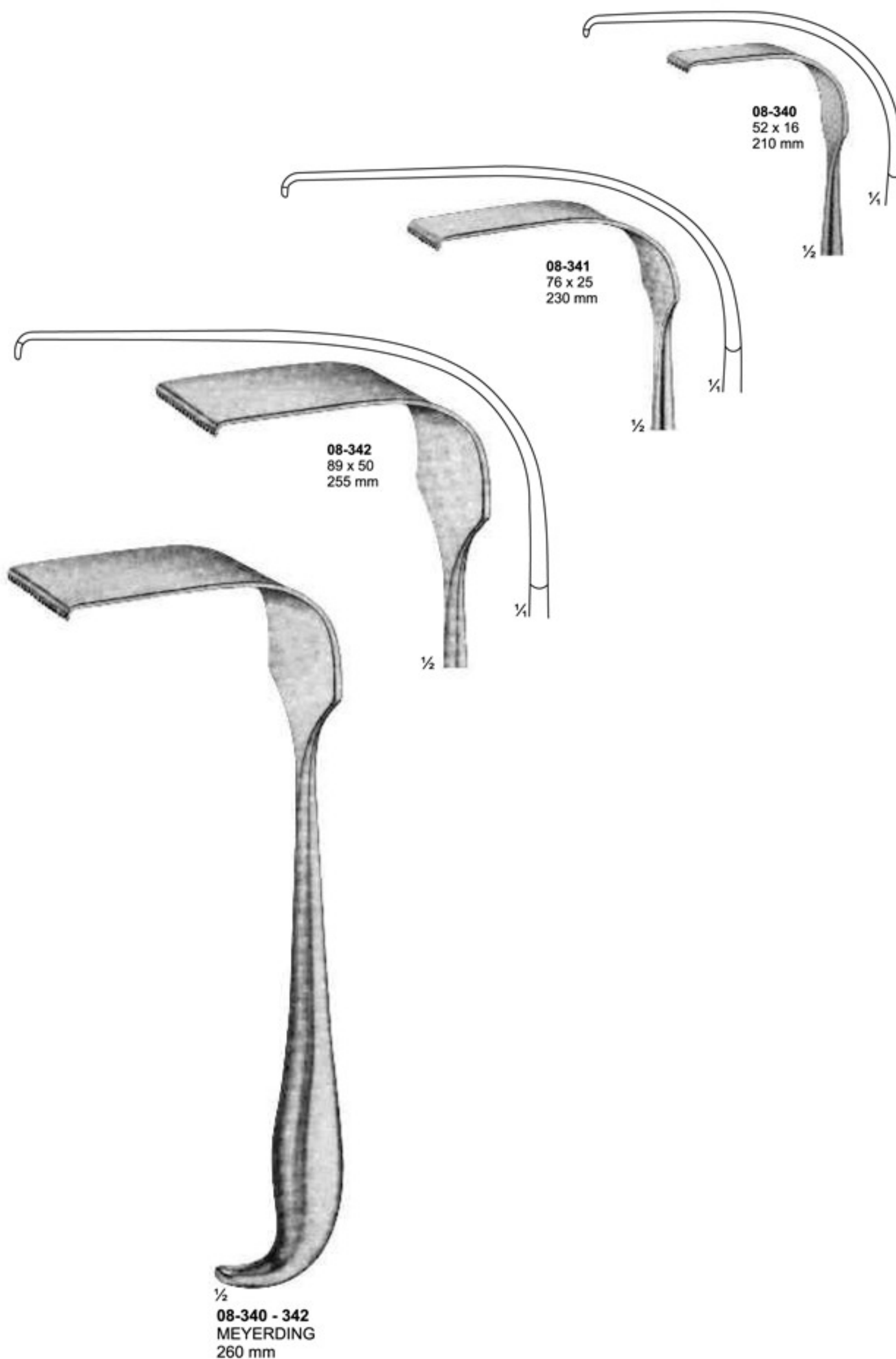

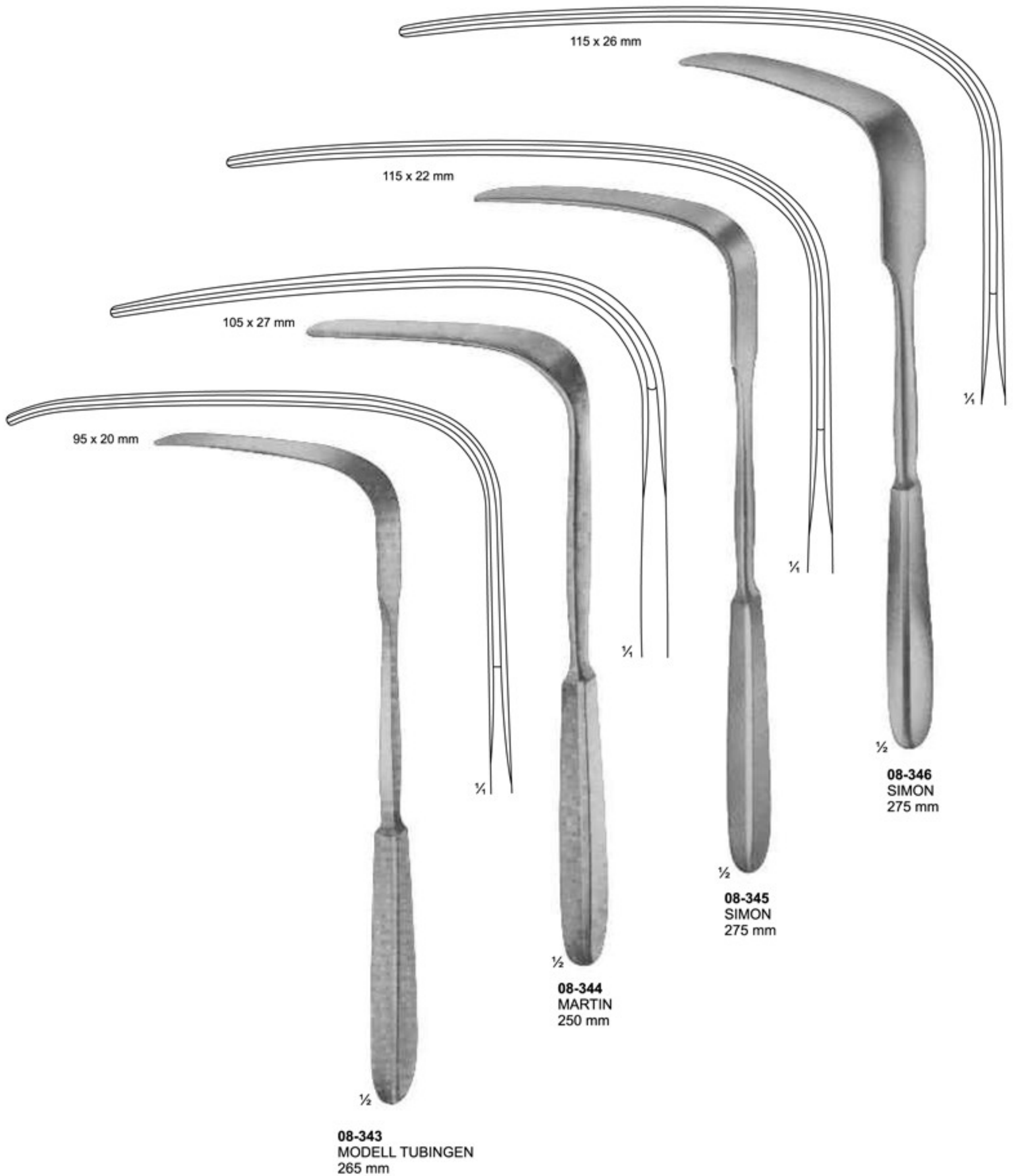

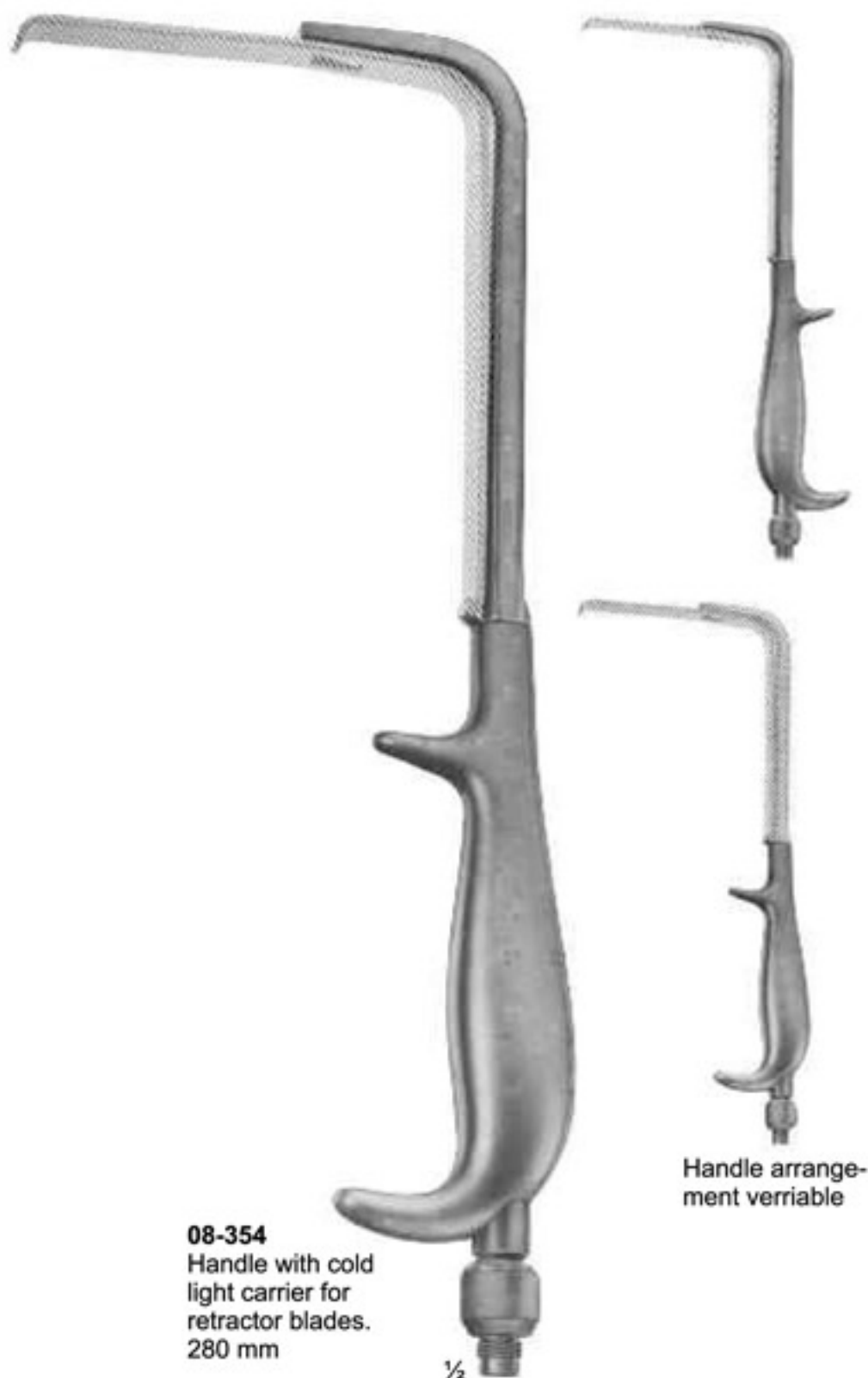

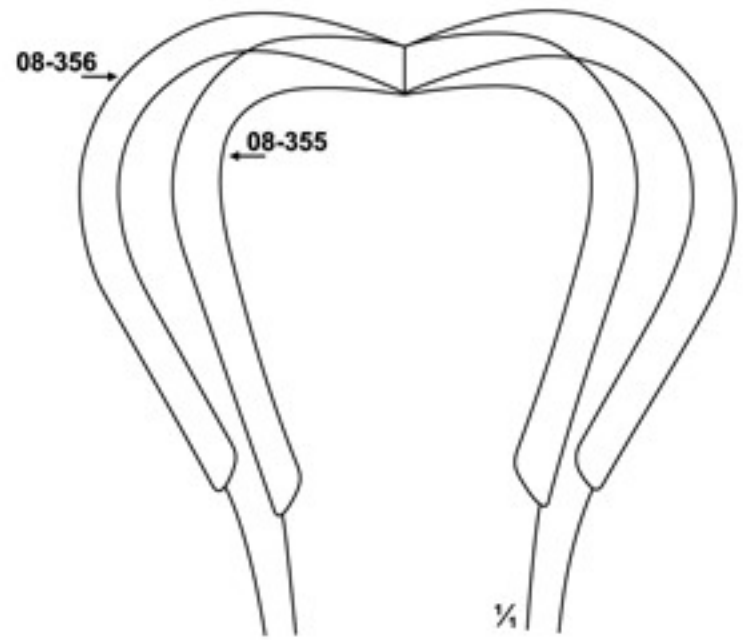

08-355 - 356
HARRINGTON
08-355 123 x 45 mm
08-356 123 x 64 mm
Flexible
295 mm



08-357
ALLISON
255 mm



08-358
ALLISON
320 mm





08-364
DEAVER
300 mm
Fig. 1

08-365
DEAVER
315 mm
Fig. 2

08-366
DEAVER
365 mm
Fig. 2



08-367
DEAVER
300 mm
Fig. 3

08-368
DEAVER
310 mm
Fig. 4

08-369
DEAVER
320 mm
Fig. 5

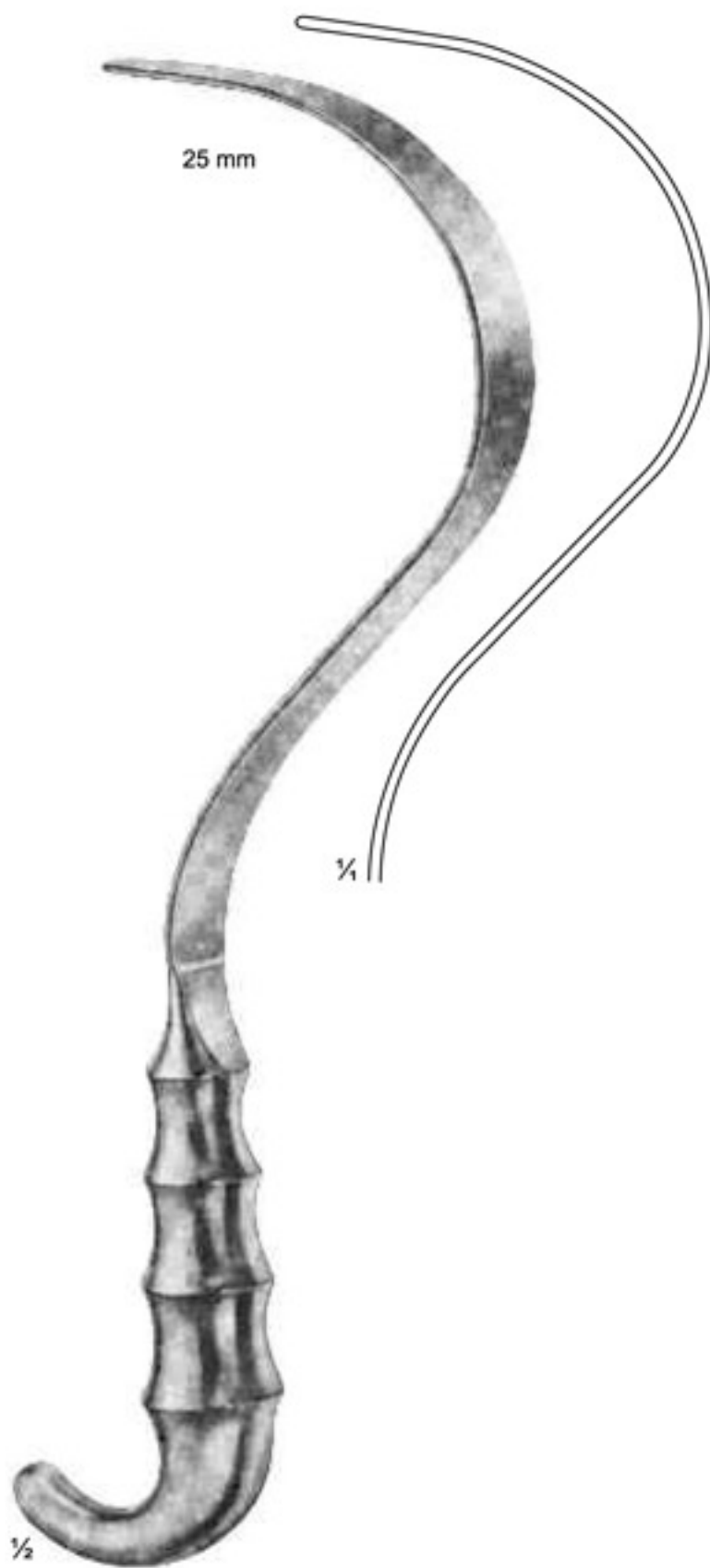

08-370
DEAVER
310 mm
Fig. 1

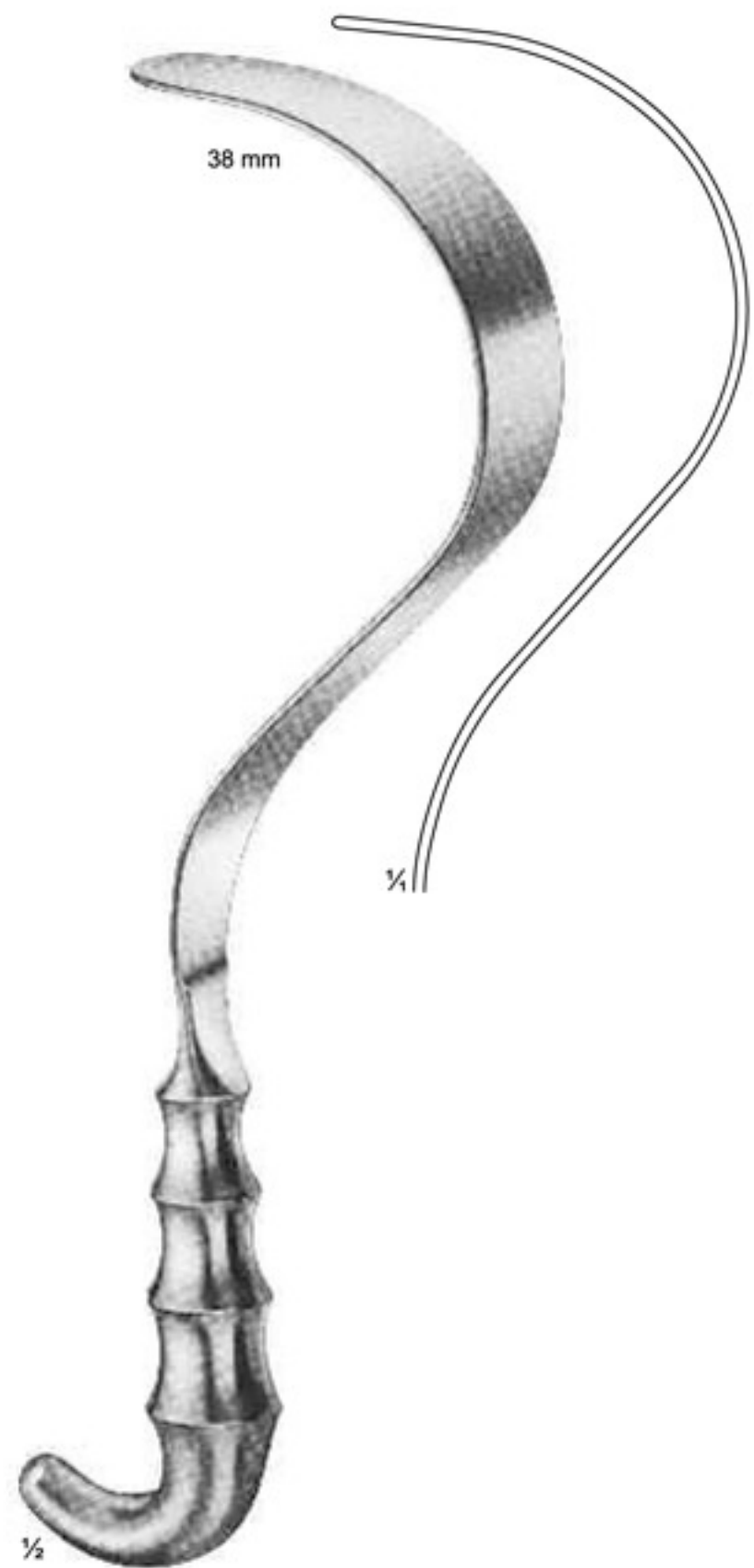

08-371
DEAVER
310 mm
Fig. 3

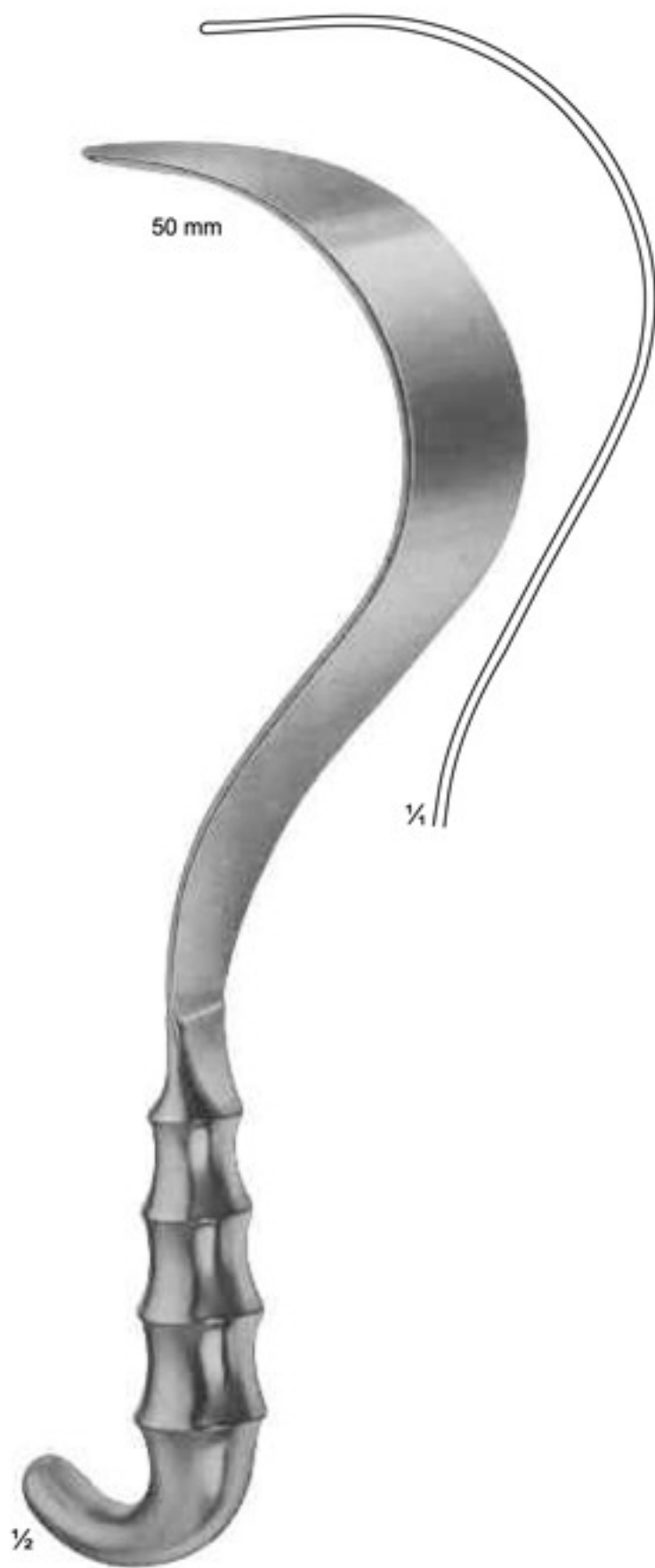

08-372
DEAVER
305 mm
Fig. 3



08-373
DEAVER
310 mm
Fig. 4

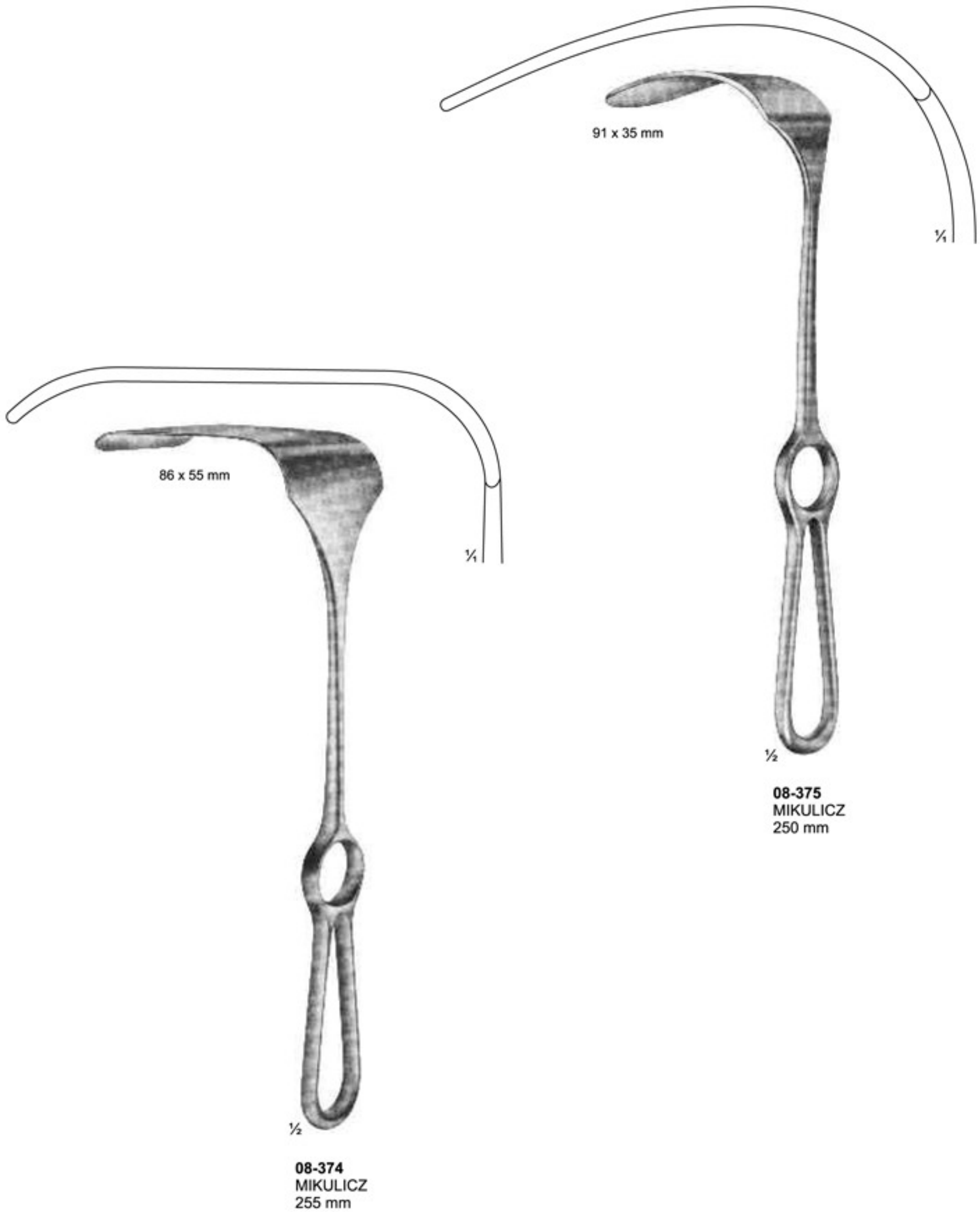

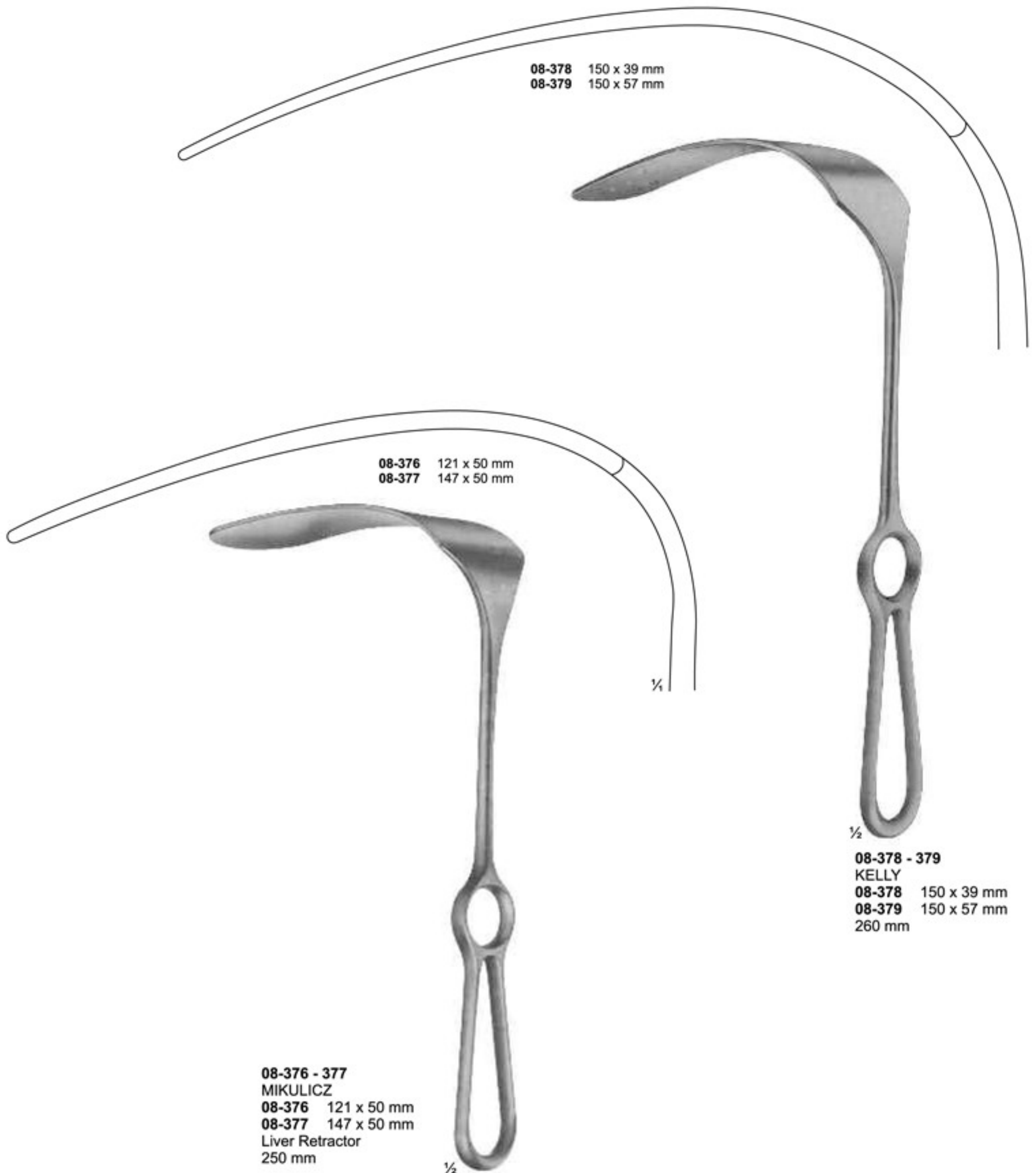

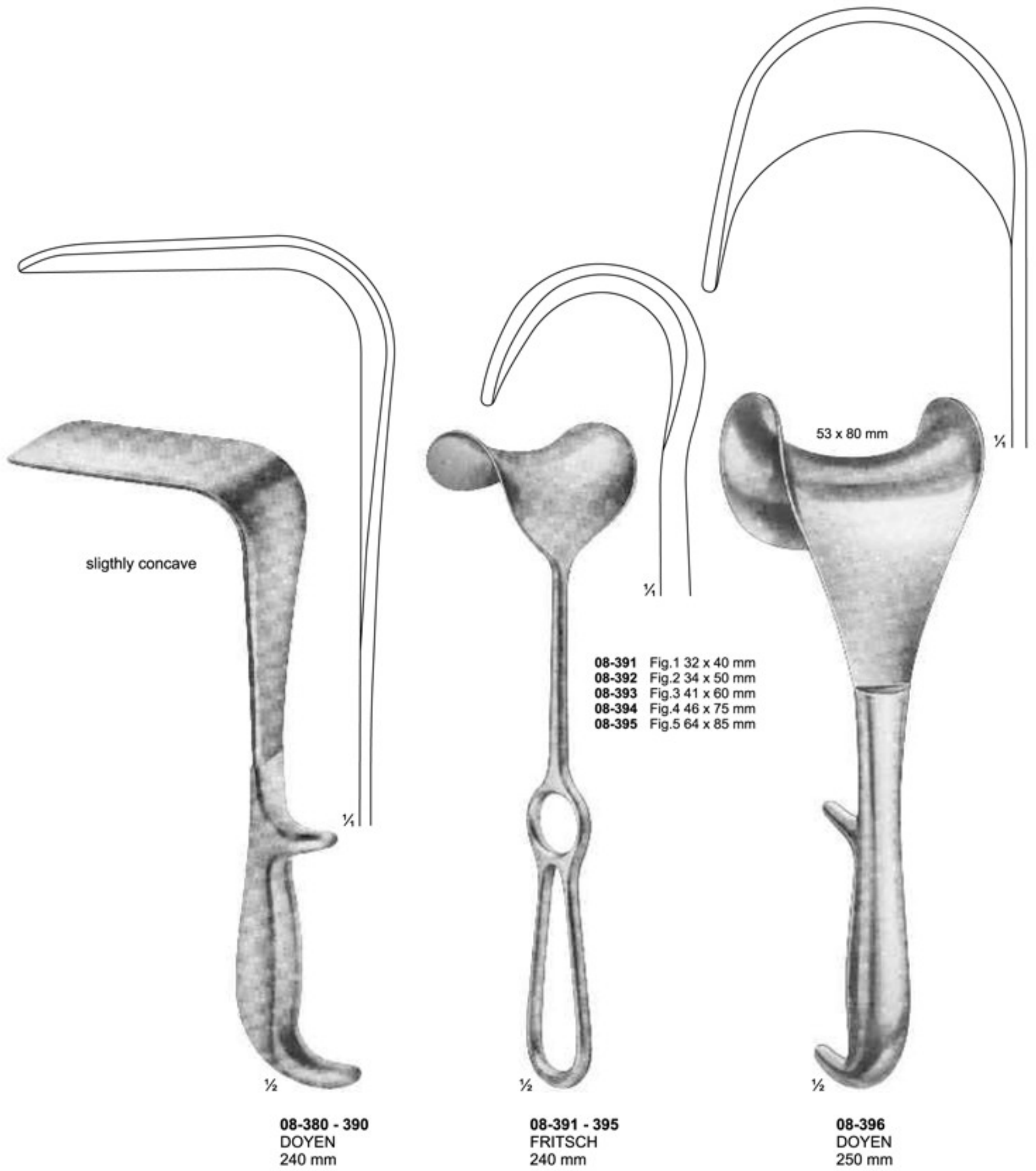

Width of Blades	
35 mm, 45 mm, 60 mm	
Length of Blades	
62 mm	08-380, 08-381, 08-382
92 mm	08-383, 08-384, 08-385
122 mm	08-386, 08-387, 08-388
160 mm	08-389, 08-390



08-397 - 401
ROCHARD
 310 mm
 08-397 48 x 90 mm
 08-398 48 x 105 mm
 08-399 48 x 120 mm
 08-400 48 x 135 mm
 08-401 48 x 155 mm



08-402



08-403 - 406
DOYEN
 280 mm
 08-403 48 x 90 mm
 08-404 48 x 105 mm
 08-405 48 x 120 mm
 08-406 48 x 135 mm



08-407
DOYEN-CHILD
 Fixation device
 220 mm



08-408
 Chain with
 weight (747 / 645g)
 790 mm

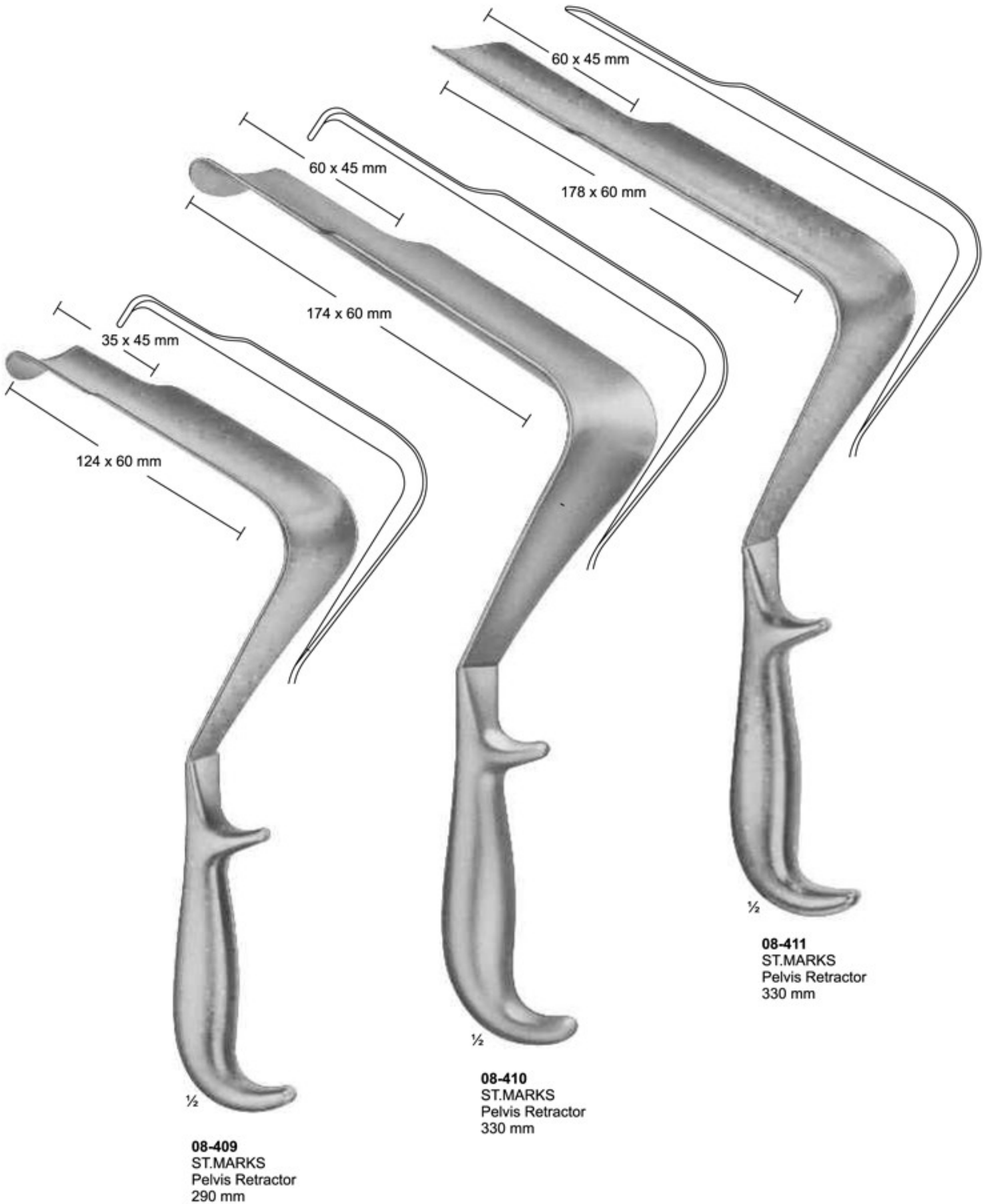

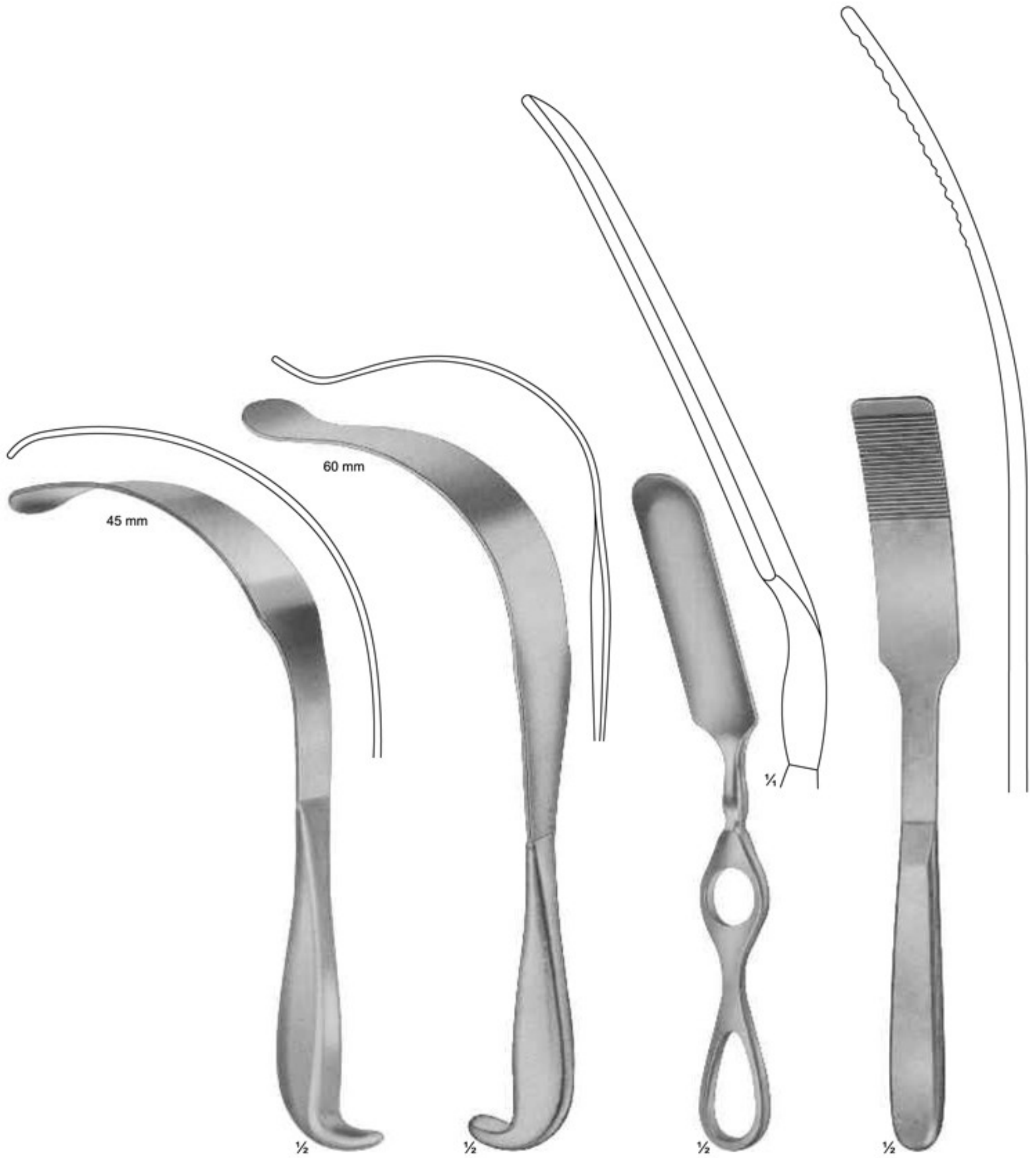

08-412
LERICHE
255 mm

08-413
KUMMEL
Melleable
285 mm

08-414
MIKULICZ
29 mm
250 mm

08-415 - 416
KADER
08-415 30 mm
08-416 40 mm
270 mm



08-417
REVERDIN
285 mm



08-418
HABERER
Malleable
305 mm



08-419 30 mm
08-420 40 mm
08-421 50 mm
Malleable
330 mm



08-422
TUFFIER
Malleable
200 mm



08-423
BOSE
60 mm



08-424
FINSEN
50 mm



08-425
FINSEN
70 mm



08-426
FINSEN modif.
75 mm



08-427
45 mm



08-428
55 mm



08-429
MUELLER
65 mm



08-430
100 mm



08-431 - 432
ALM
08-431 70 mm
08-432 100 mm



08-433
LOGAN
modif. REILL
50 mm



08-434
JANSEN
100 mm



08-435
JANSEN
100 mm

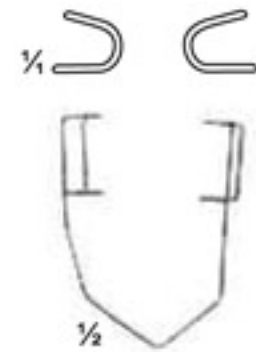

08-436
BARRAQUER
45 mm



08-437
WEITLANER
Sharp
110 mm

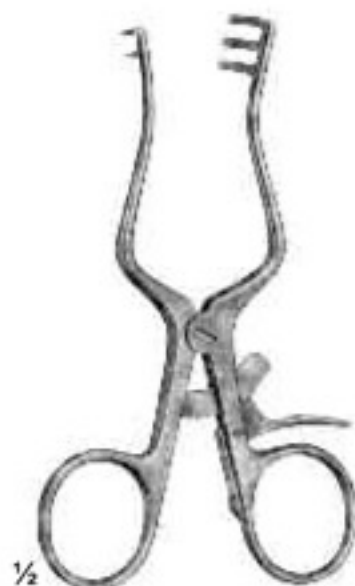

08-438
WEITLANER
Semi-Sharp
110 mm



08-439
WEITLANER
Blunt
110 mm



08-440
WEITLANER
Sharp
130 mm



08-441
WEITLANER
Semi-Sharp
130 mm



08-442
WEITLANER
Blunt
130 mm

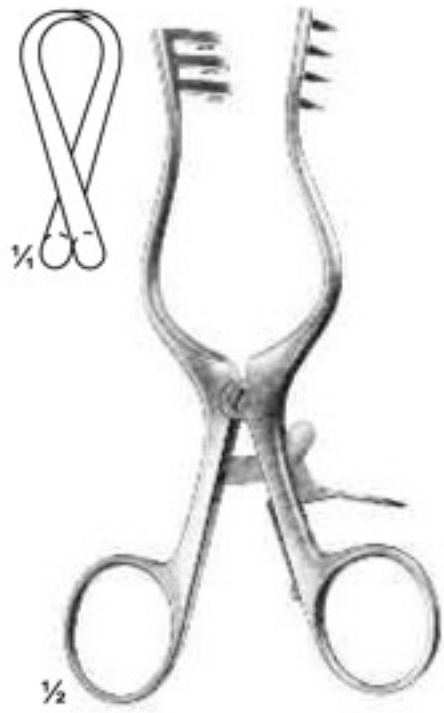

08-443
WEITLANER
Sharp
130 mm

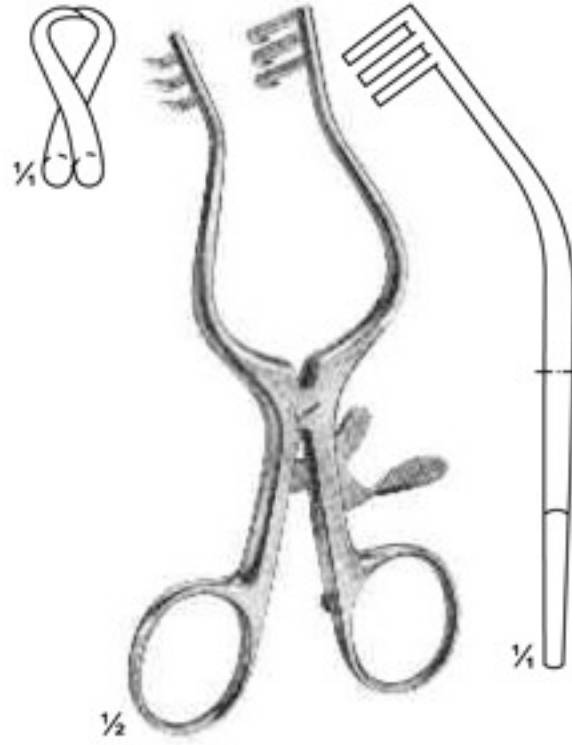

08-444
WULLSTEIN
Sharp
130 mm

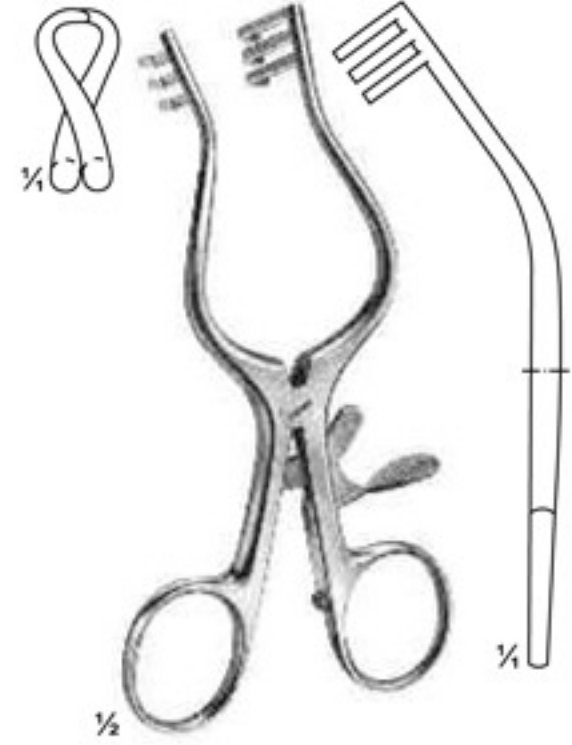

08-445
WULLSTEIN
Blunt
130 mm



08-446
WEITLANER
Sharp
165 mm



08-447
PLESTER
Blunt
110 mm

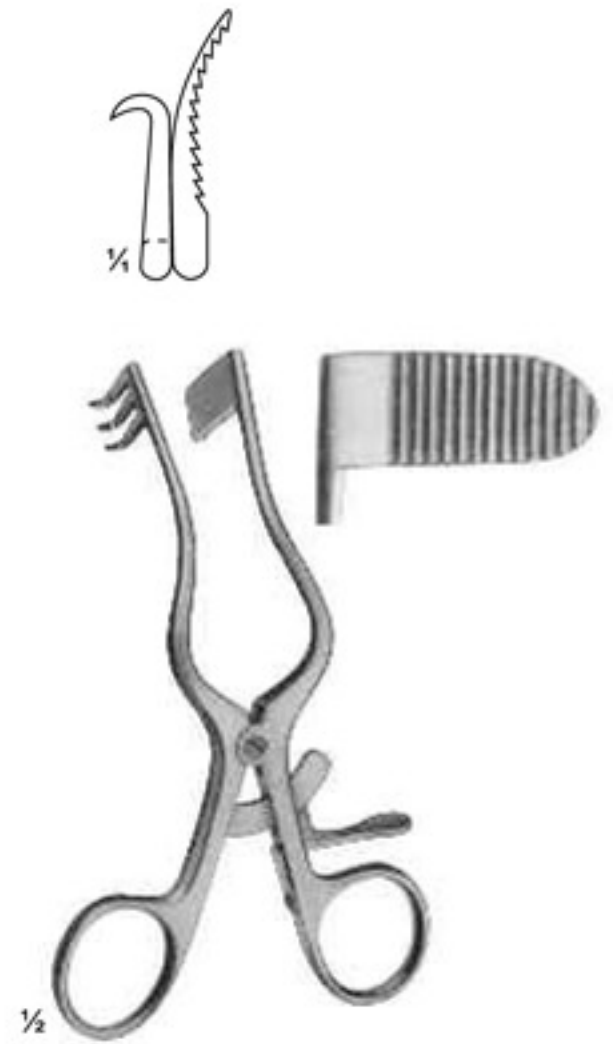

08-448
PERKINS
Blunt
130 mm



08-449
ADSON-BABY
Blunt
140 mm

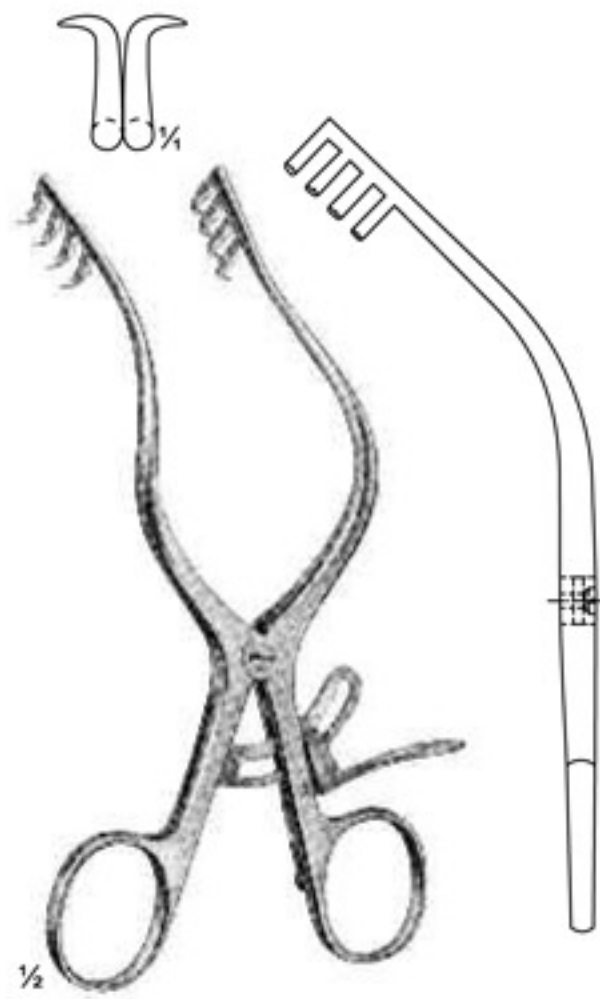

08-450
MOLLISON
Sharp
155 mm

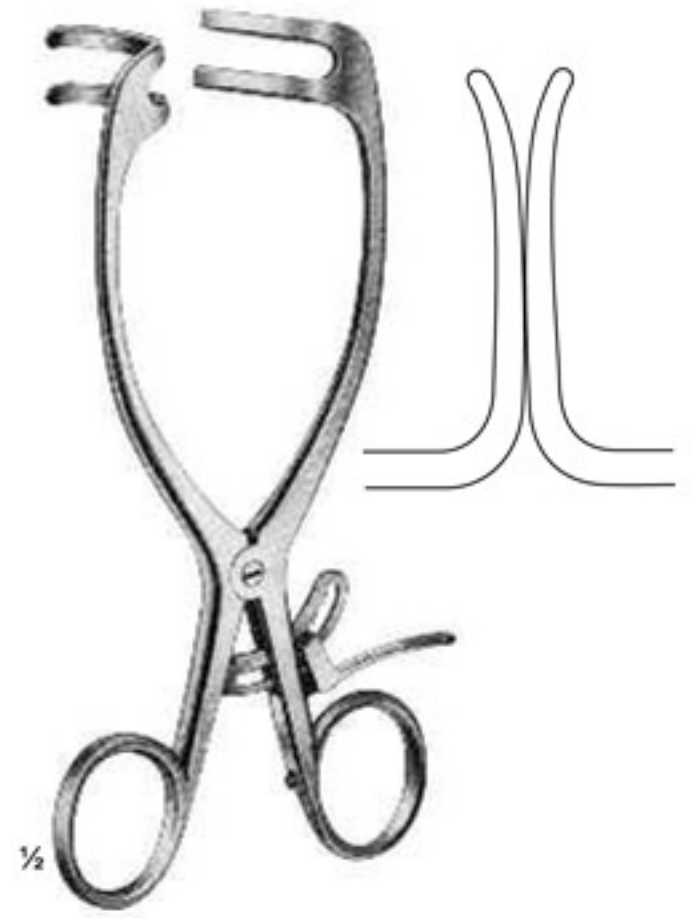

08-451
MAYO-ADAMS
165 mm

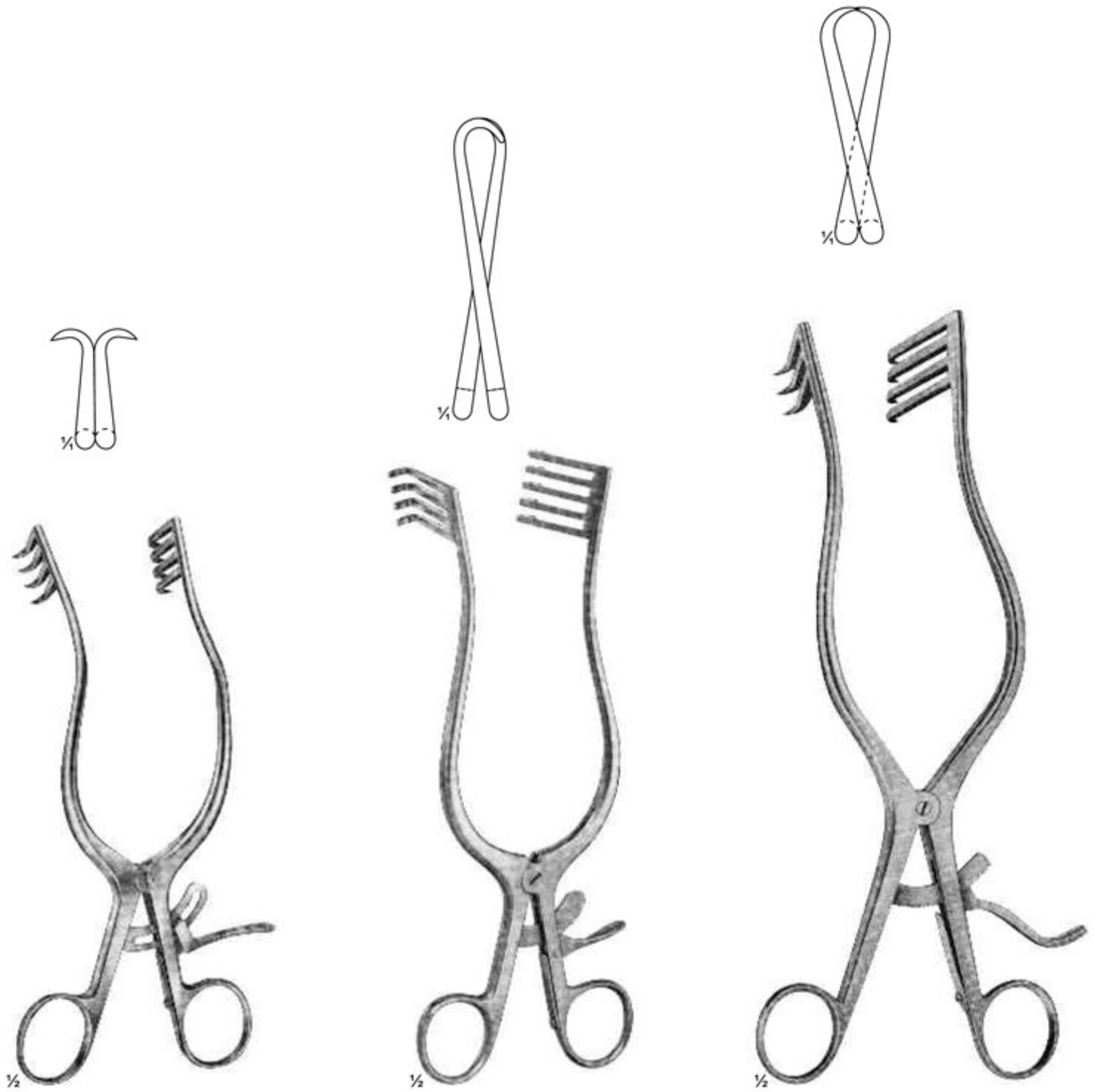

08-452
ANDERSON-ADSON
 Sharp
 190 mm

08-453
NORFOLK and
NORWICH
 Blunt
 220 mm

08-454
ADSON
 Sharp
 265 mm

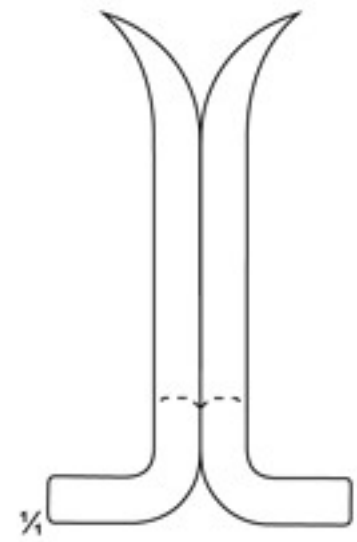
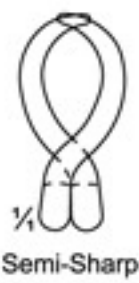

08-455 - 456
BECKMANN-ADSON
Sharp
310 mm



08-456
BECKMANN-ADSON
Semi-Sharp
310 mm

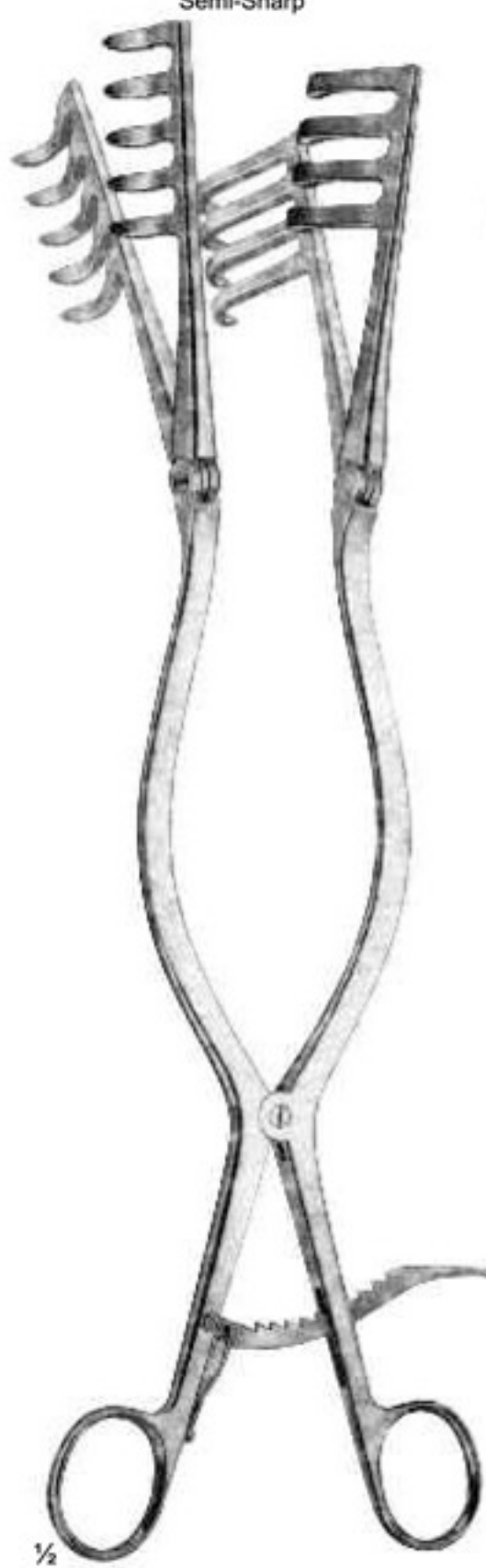

08-457
ADSON
Semi-Sharp
320 mm



08-458
BECKMANN-EATON
Sharp
320 mm



08-459
JOLL (FRIEDMAN)
 Thyroid- and Vaginal Retractor
 155 mm

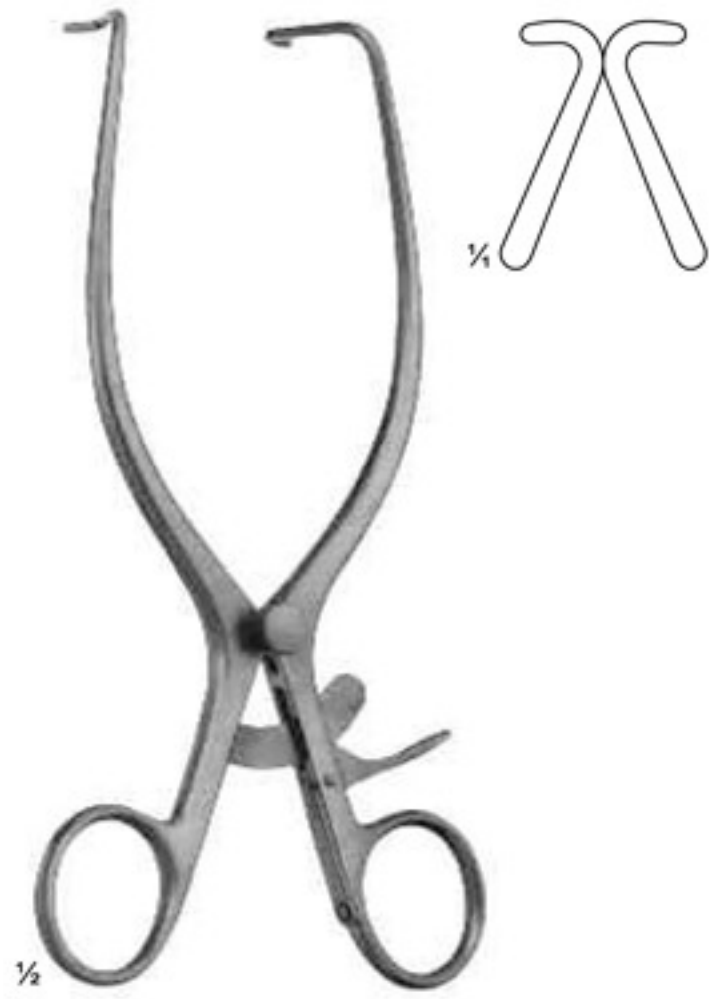

08-460
JACKSON BURROWS
 Retractor, blunt
 185 mm



08-461
GELPI
 Vaginal Retractor
 135 mm

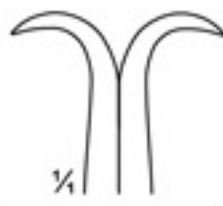

08-462
GELPI
 Skin- and Vaginal Retractor
 175 mm

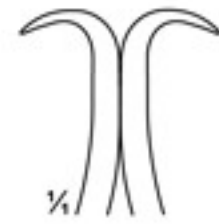

08-463
DE BAKEY
 Femur Retractor
 145 mm

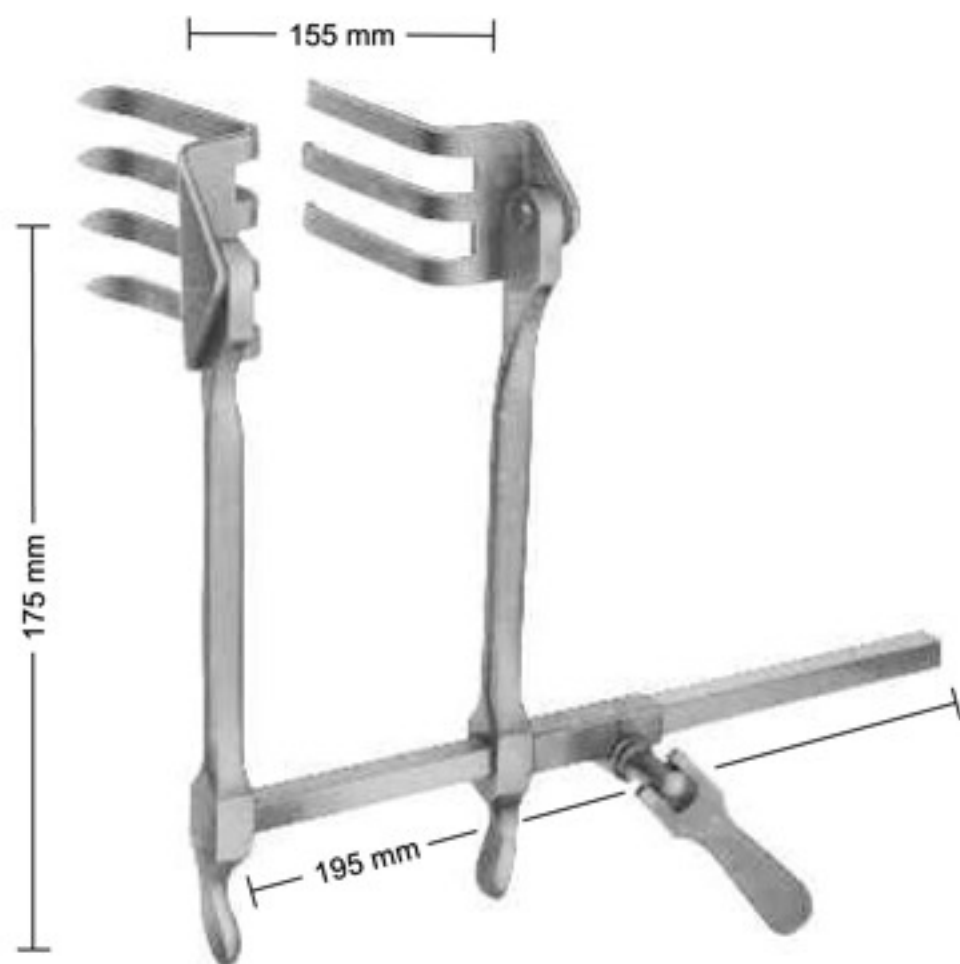

08-464 - 468
 SCOVILLE-RICHTER
 Retractor with 1 pair
 blades reversible type.
 The Retractor bar and
 shanks may be easily
 rotated 180° when
 blades are in situ.



08-465
 62 x 52 mm 62 x 37 mm
 PR= Pair



08-466
 47 x 51 mm



08-467
 30 x 40 mm



08-468
 37 x 62 mm



08-469
CLOWARD modif.
Spreader Only



16 mm
08-470

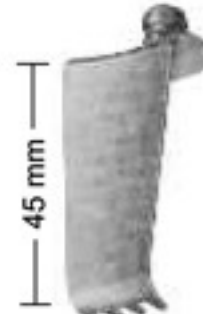

16 mm
08-471



16 mm
08-475



16 mm
08-476

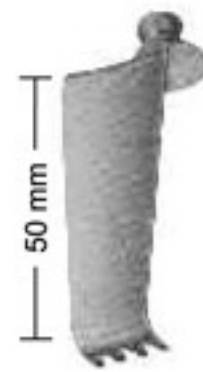

16 mm
08-472

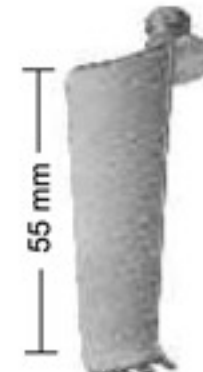

16 mm
08-473

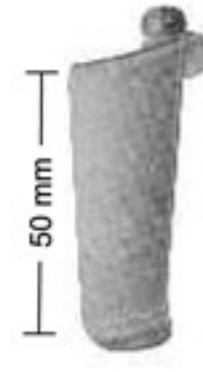

16 mm
08-477

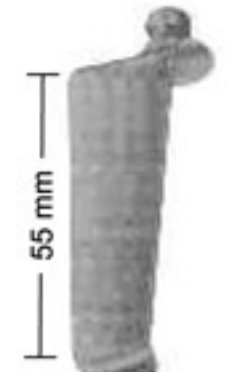

16 mm
08-478

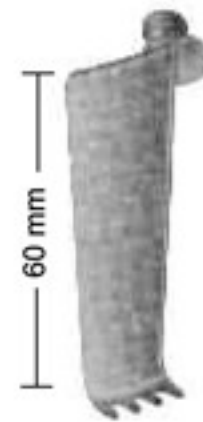

16 mm
08-474

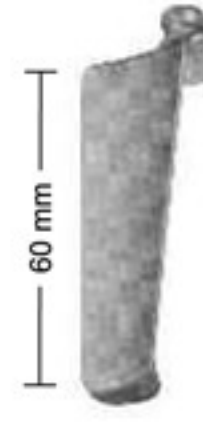

16 mm
08-479

- 08-470 blade
- 08-471 blade
- 08-472 blade
- 08-473 blade
- 08-474 blade

- 08-475 blade
- 08-476 blade
- 08-477 blade
- 08-478 blade
- 08-479 blade

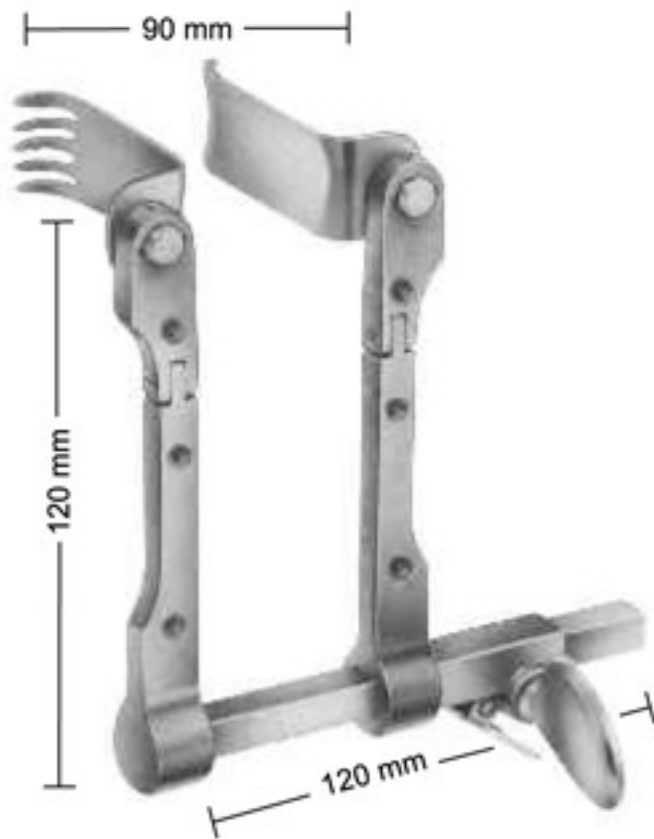

08-480
CASPAR
Retractor, adjustable,
consisting of: 5 medial
blades, 5 Lateral blades.

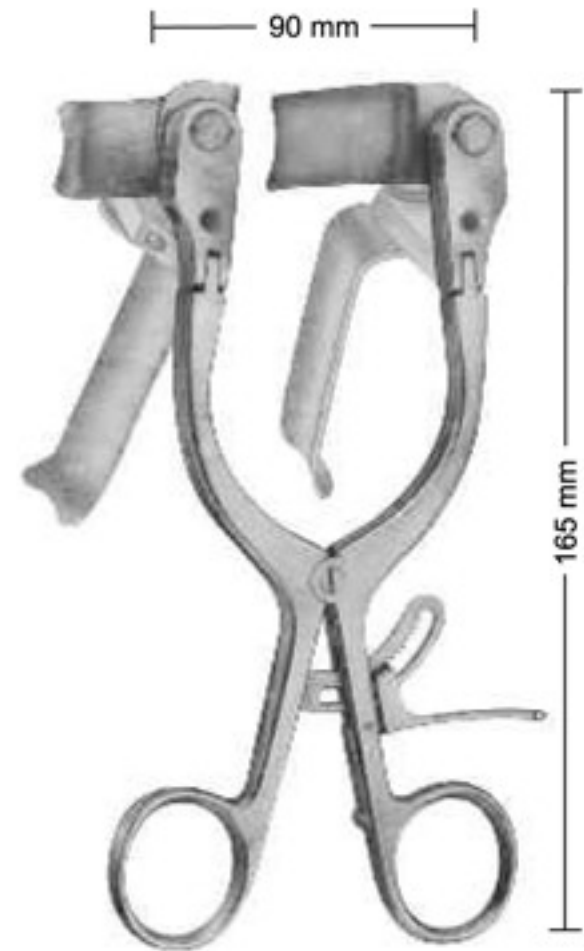

08-480 A
CASPAR
Counter retractor, adjustable,
consisting of: 5 blades.



08-481 40 x 23 mm
08-482 45 x 23 mm
08-483 50 x 23 mm
08-484 55 x 23 mm
08-485 60 x 23 mm
Medial blades

08-486 40 x 23 mm
08-487 45 x 23 mm
08-488 50 x 23 mm
08-489 55 x 23 mm
08-490 60 x 23 mm
Lateral blades

08-491 45 x 23 mm
08-492 50 x 23 mm
08-493 55 x 23 mm
08-494 60 x 23 mm
08-495 65 x 23 mm
Blunt blades

08-496 50 x 25 mm
08-497 60 x 25 mm
Blunt blades,
for harvesting of the
fusion graft from the
iliac crest

08-498 40 x 25 mm
08-499 45 x 25 mm
08-500 50 x 25 mm
08-501 55 x 25 mm
08-502 60 x 25 mm
Medial Titan blades
semi transparent to x-ray

08-503 40 x 25 mm
08-504 45 x 25 mm
08-505 50 x 25 mm
08-506 55 x 25 mm
08-507 60 x 25 mm
Lateral Titan blades
semi transparent to x-ray



08-508
CLOWARD
155 mm



08-509
CLOWARD
135 mm

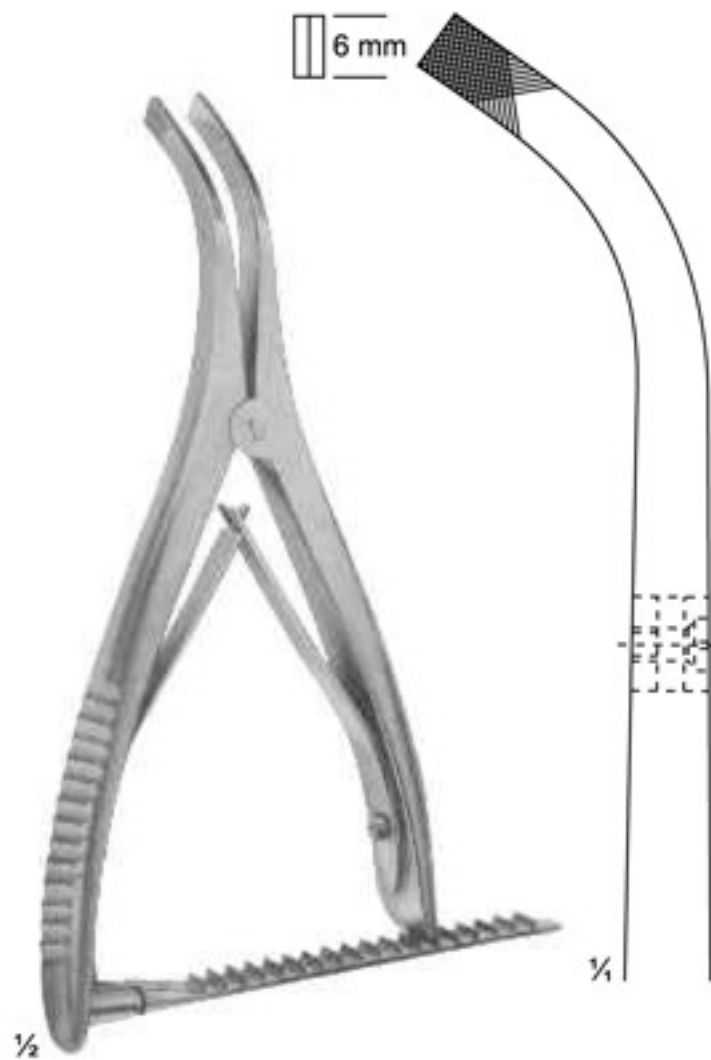

08-510
INGE
170 mm

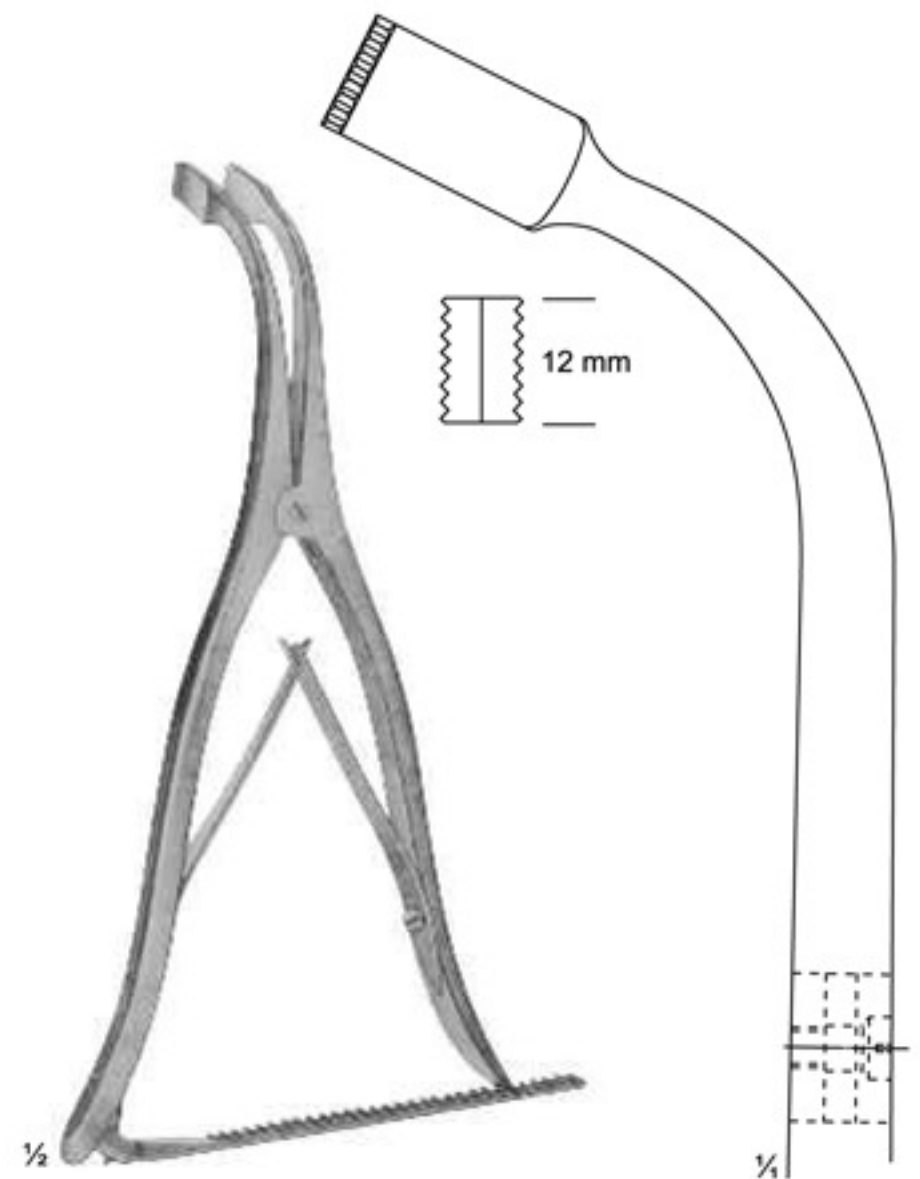

08-511
INGE
275 mm



08-512
BABY-COLLIN
with 2 pair of blades

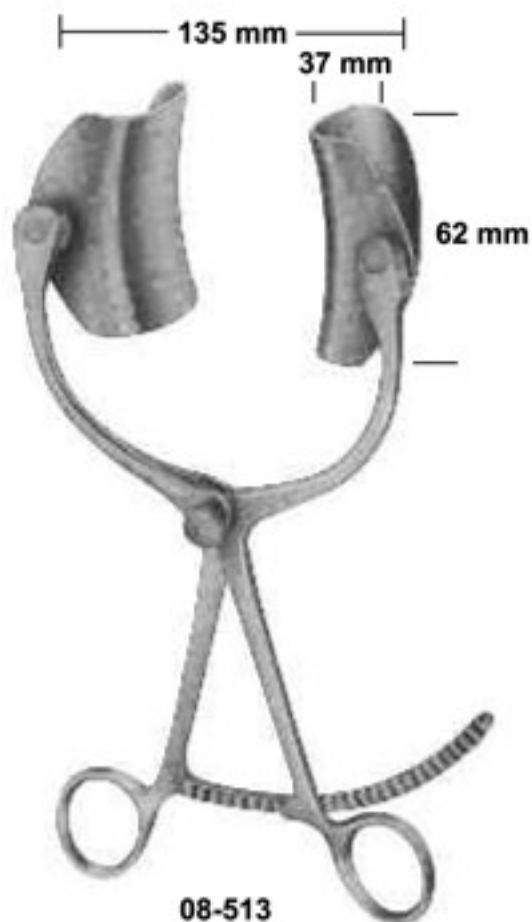

08-513
COLLIN
complete



08-817 135 mm
08-818 160 mm

08-516 37x98mm
08-515 37x80mm
08-514 37x62mm
08-518 54x67mm
Spreader only
Lateral blade
Canter blade

08-514 - 518
COLLIN
complete



08-519 - 520
RICARD
complete

Spreader only **08-519** **08-520**
Lateral blade 58x80mm 72x84mm
Canter blade 54x70mm 72x90mm



08-521 - 523
HOLZBACH
Complete

08-521 Spreader only
08-522 Lateral blade 59x80mm
08-523 Canter blade 74x82mm

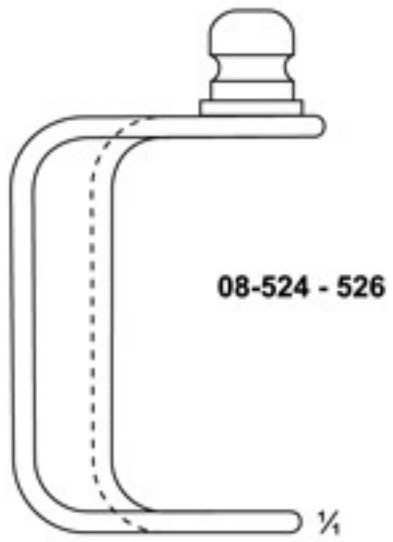

Lateral blades only
08-524 37x62 mm
08-525 37x80 mm
08-526 37x98 mm

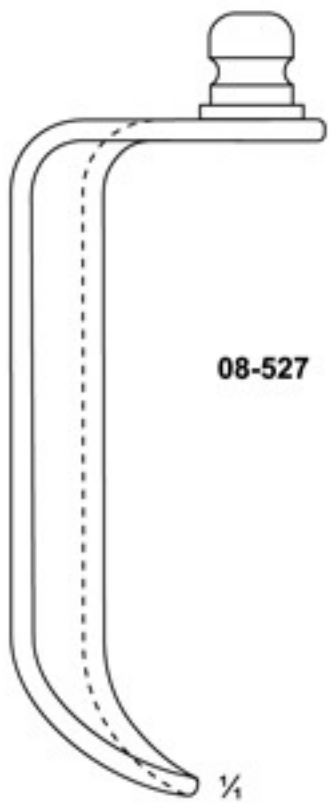

08-527 61x80 mm

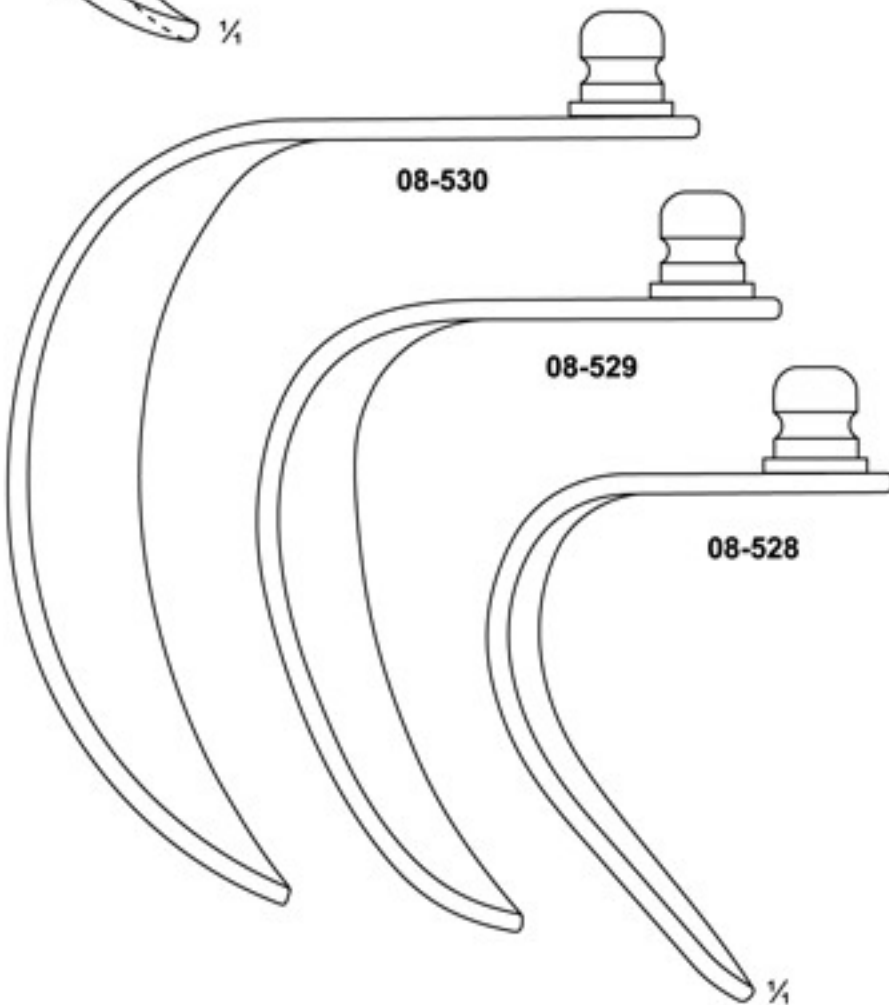

08-528 48x59 mm
08-529 58x80 mm
08-530 72x84 mm

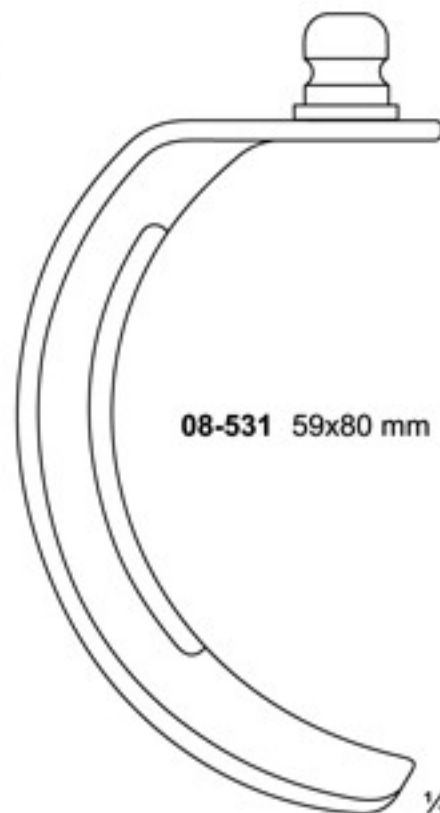

08-531 59x80 mm



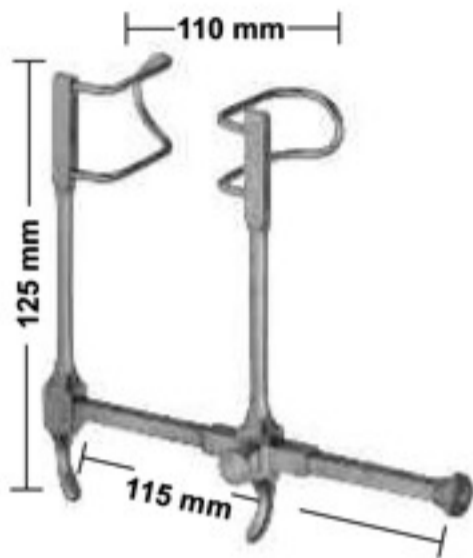

08-532
GOSSET
Blades:38 mm deep

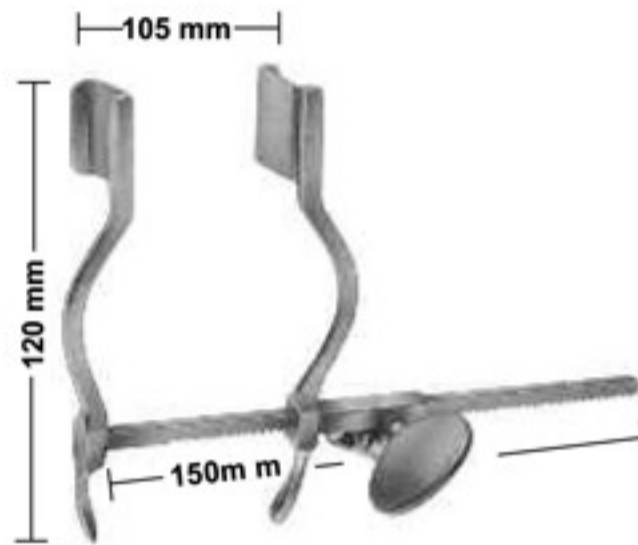

08-533
HERTZLER
Blades 20 X 25 mm

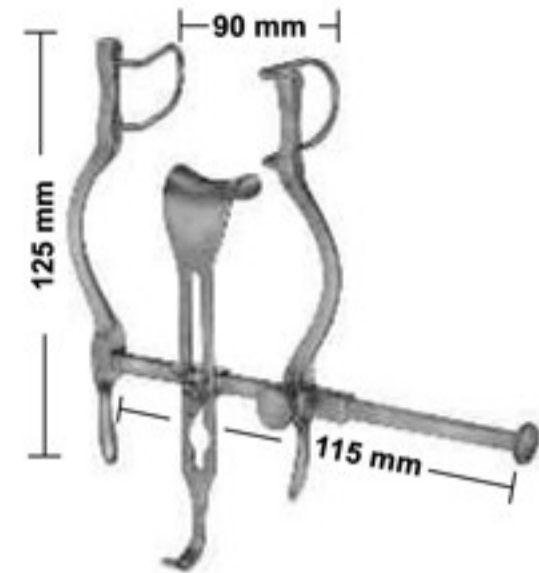

08-534
BALFOUR-BABY
Lateral blades 27 mm deep
Center blade 21x24 mm

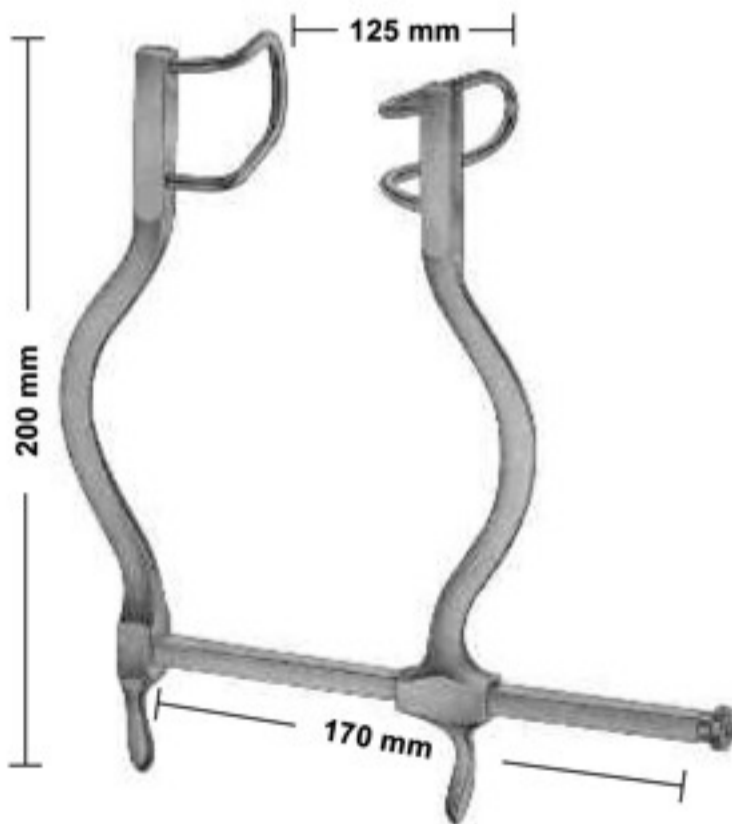

08-535
GOSSET
Blades:55mm deep

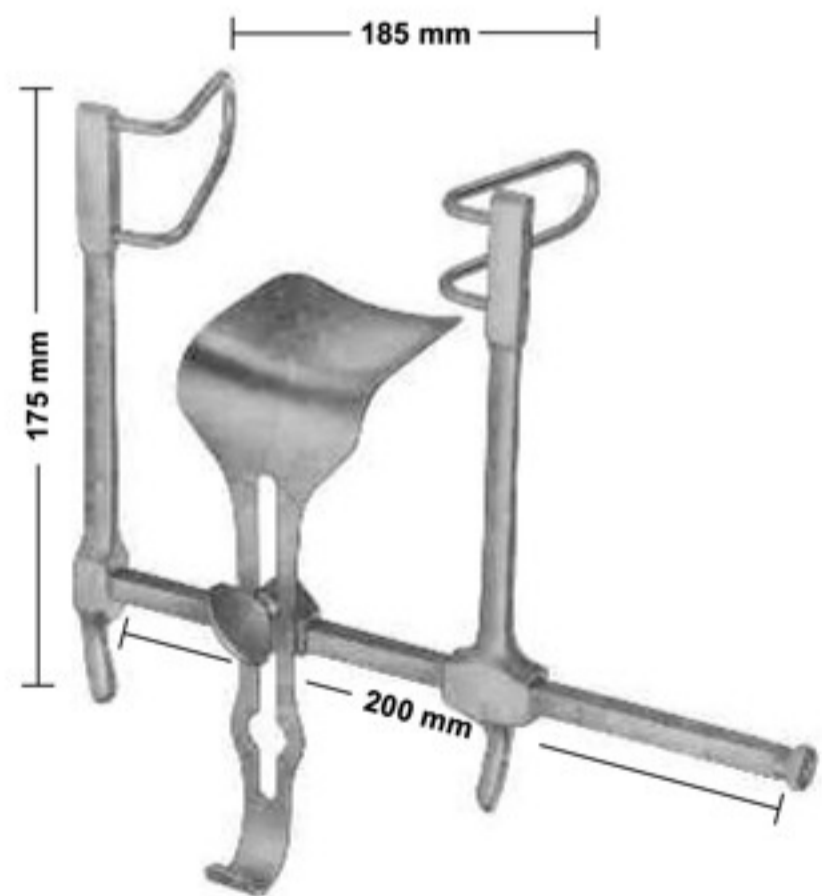

08-536
GOSSET
Lateral blades 58 mm deep
Center blade 59 x 57 mm

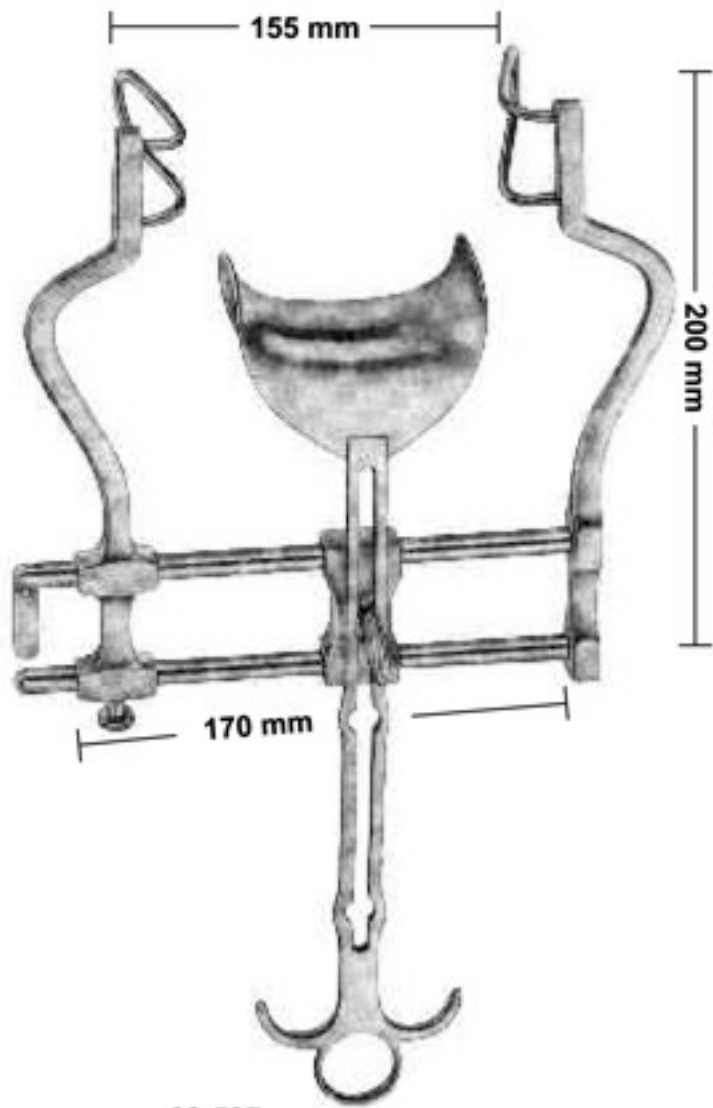

08-537
BALFOUR
Lateral blades 60 mm deep
Center blade 47 x 80 mm

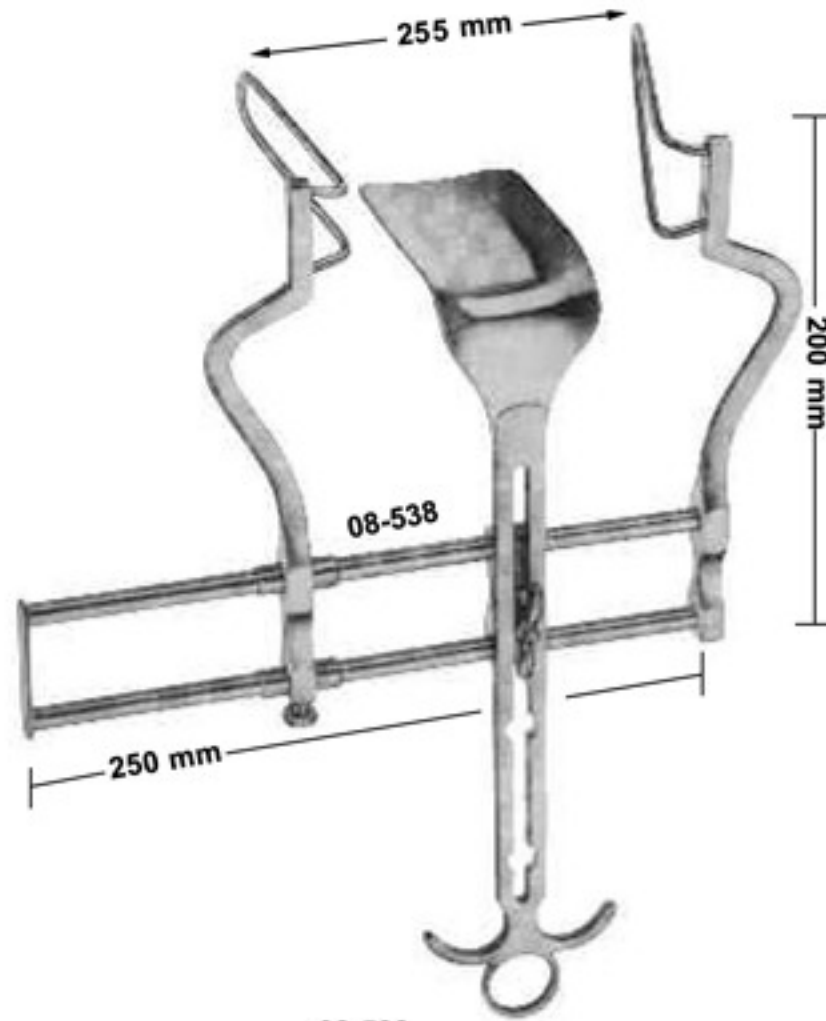

08-538
BALFOUR
Lateral blades 105 mm deep
Center blade 107x 59 mm

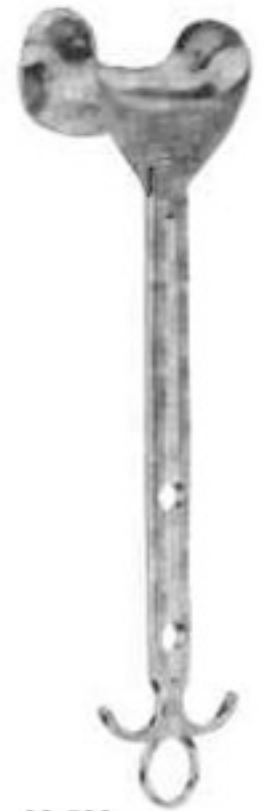

08-539
Center blade only
54x80 mm

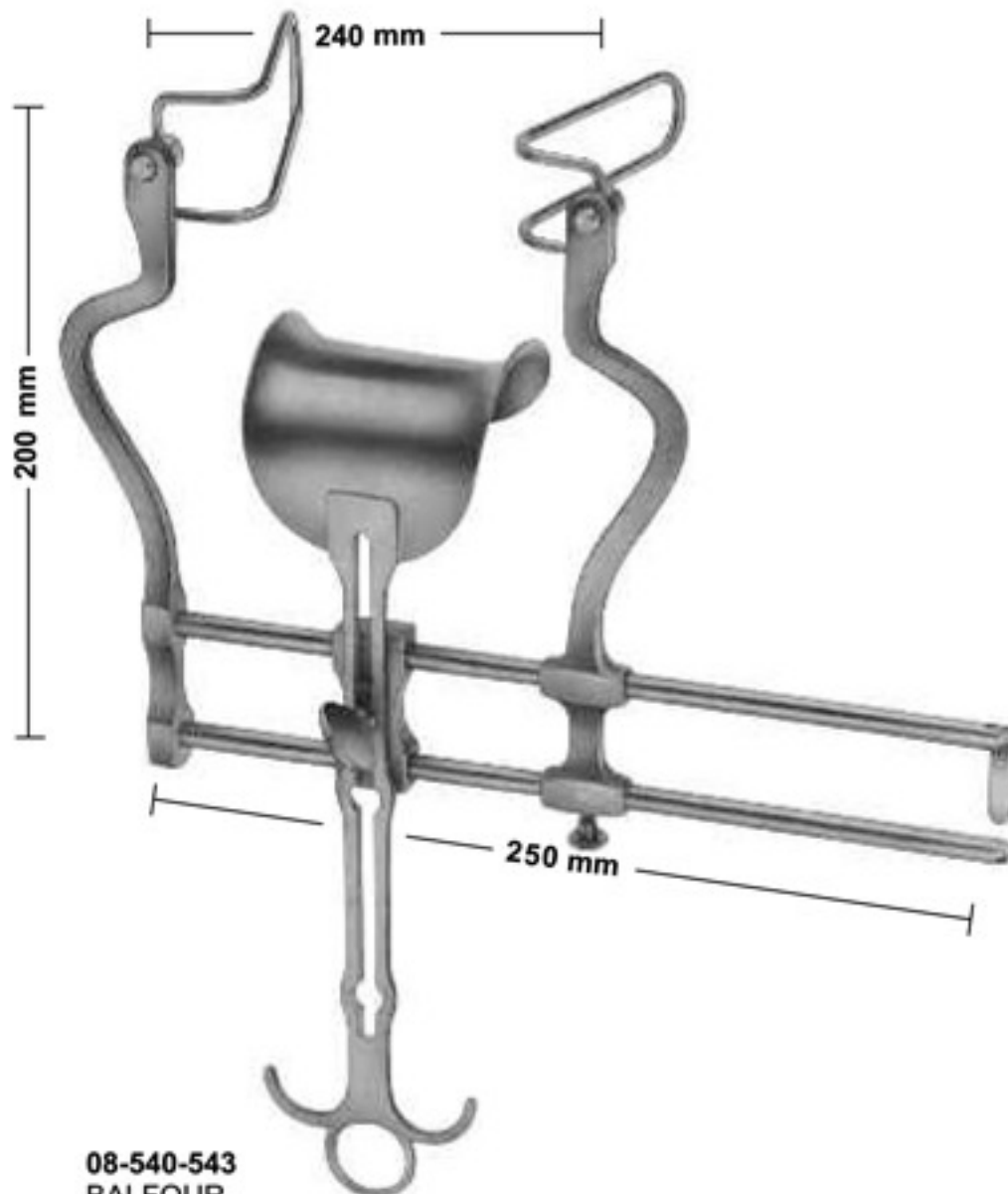

08-540-543
BALFOUR
Spreader only
Lateral blades 50 mm 60 mm 75 mm 90 mm
Center blade 47 x 80 mm 62x76 mm 80x80 mm 80x80 mm



Sales Unit of blades:PR = pair

Lateral blades
08-544 50 mm deep
08-545 60 mm deep
08-546 75 mm deep
08-547 90 mm deep

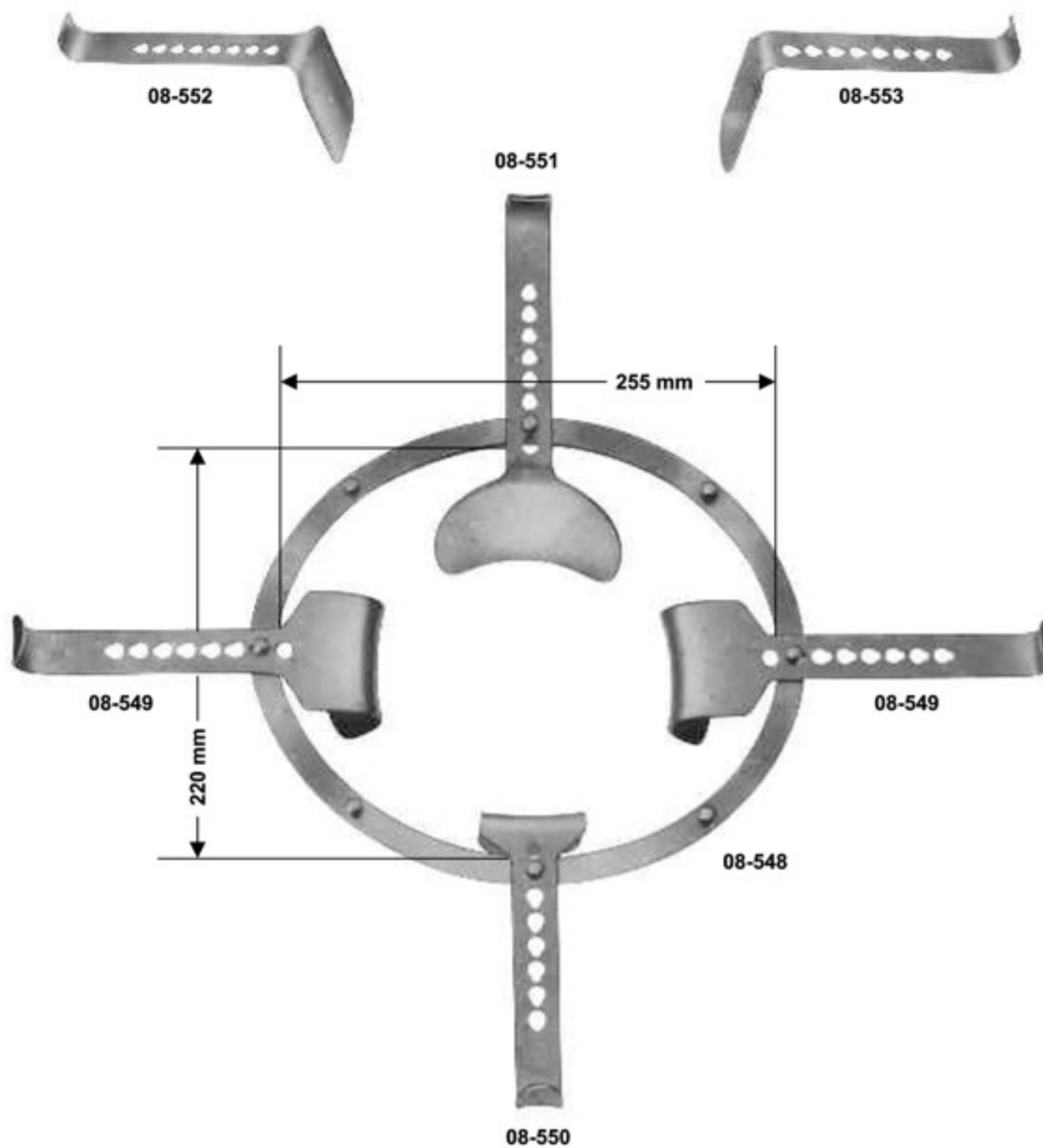

- 08-548 - 08-553**
 SEMM
 consisting of:
- 08-548** 1 frame 225 x 220 mm
 - 08-549** 2 blades 46 x 64 mm
 - 08-550** 1 blade 53 x 54 mm
(for bladder)
 - 08-551** 1 blade 82 x 97 mm
(for intestine)
 - 08-552** 1 blade 98 x 51 mm
(for intestine)
 - 08-553** 1 blade, narrow
107 x 36 mm

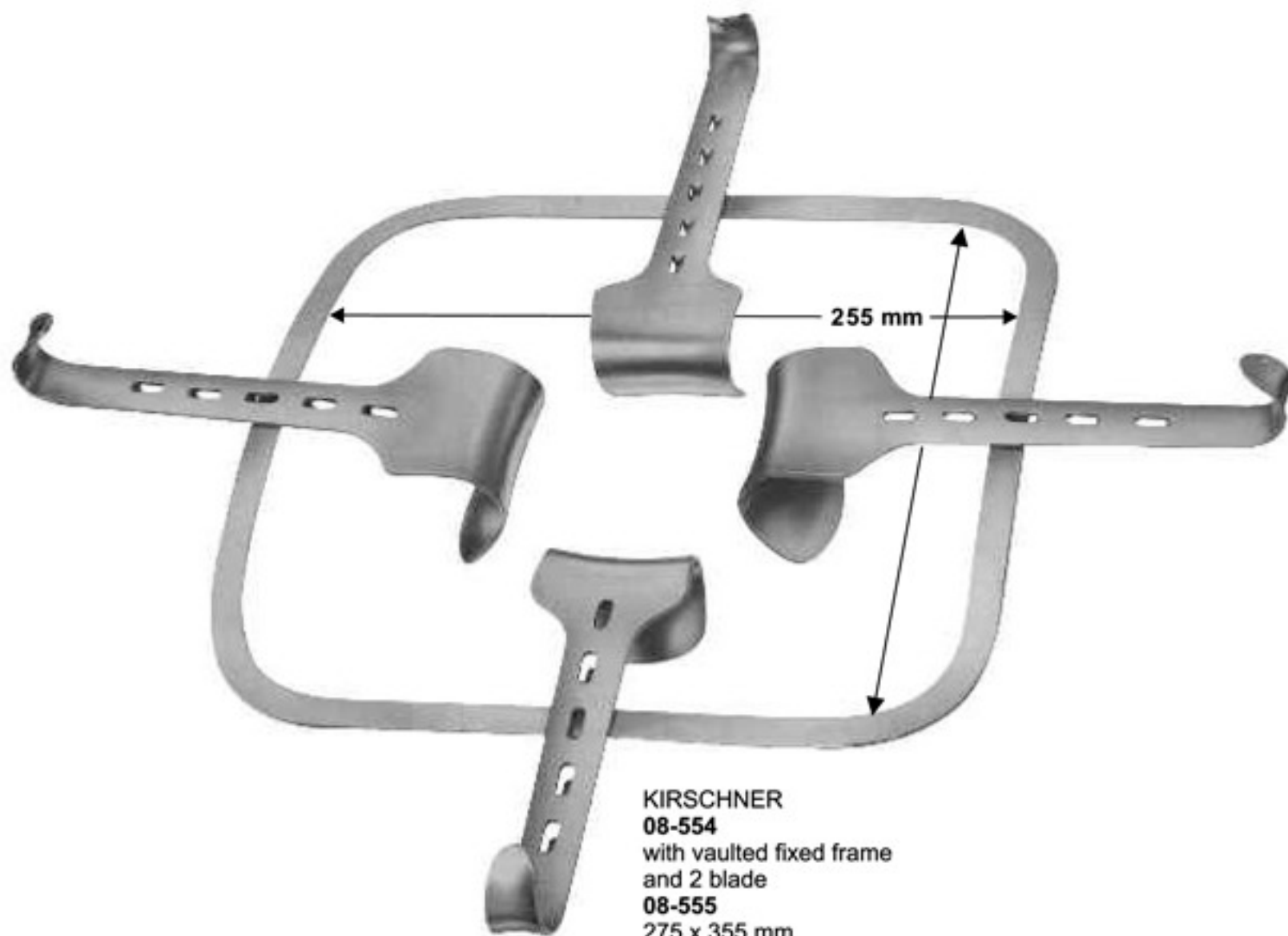

KIRSCHNER
08-554
 with vaulted fixed frame
 and 2 blade
08-555
 275 x 355 mm
 Frame only, over-sized
08-556
 295 x 275 mm
 Frame only



08-557
KIRSCHNER
 64 x 80 mm



08-558
KIRSCHNER-BALFOUR
 80x 82 mm



08-559 - 561
KIRSCHNER
08-559 90x 69mm
08-560 92x 95mm
08-561 78x 58mm



08-562 - 564
KIRSCHNER
08-562 108x42mm
08-563 91x 55mm
08-564 121x 55mm

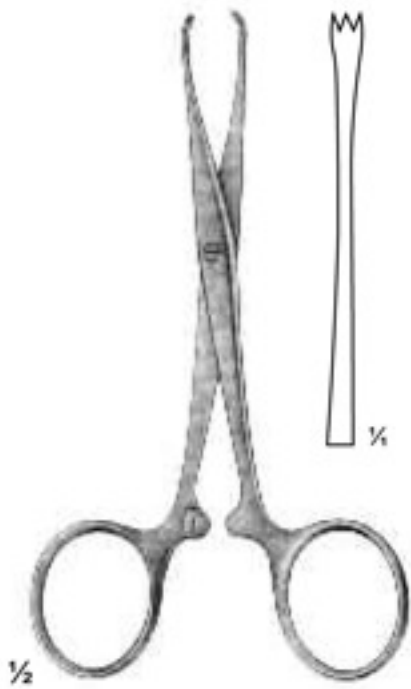

09-101
CHAPUT
 2 X 3 teeth, sharp
 125 mm,

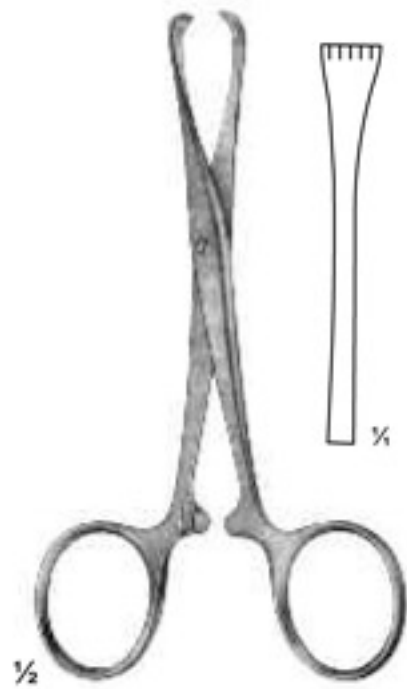

09-102
TUFFIER
 5 X 6 teeth, sharp
 125 mm,



09-103
BOYS-ALLIS
 5 X 6 teeth, sharp
 155 mm,

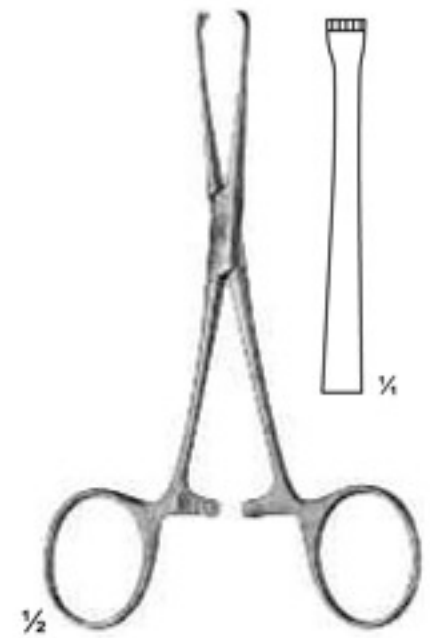

09-104
ALLIS
 4 X 5 teeth
 155 mm,

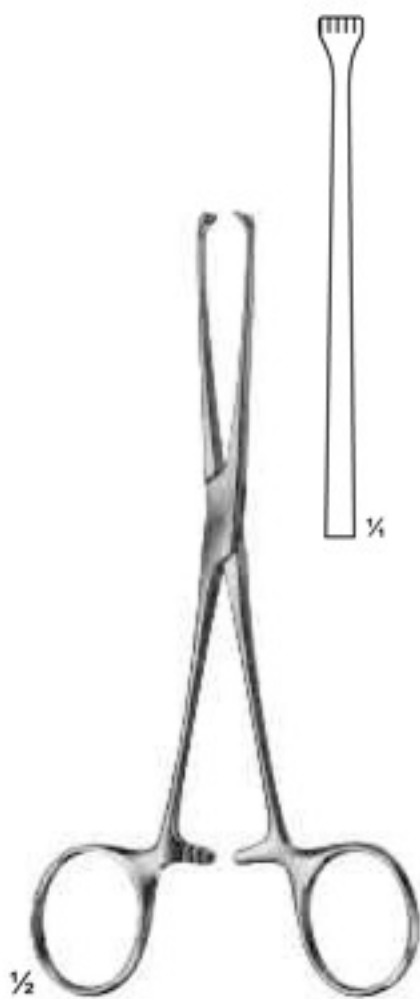

09-105
ALLIS
 155 mm,
 4 X 5 teeth

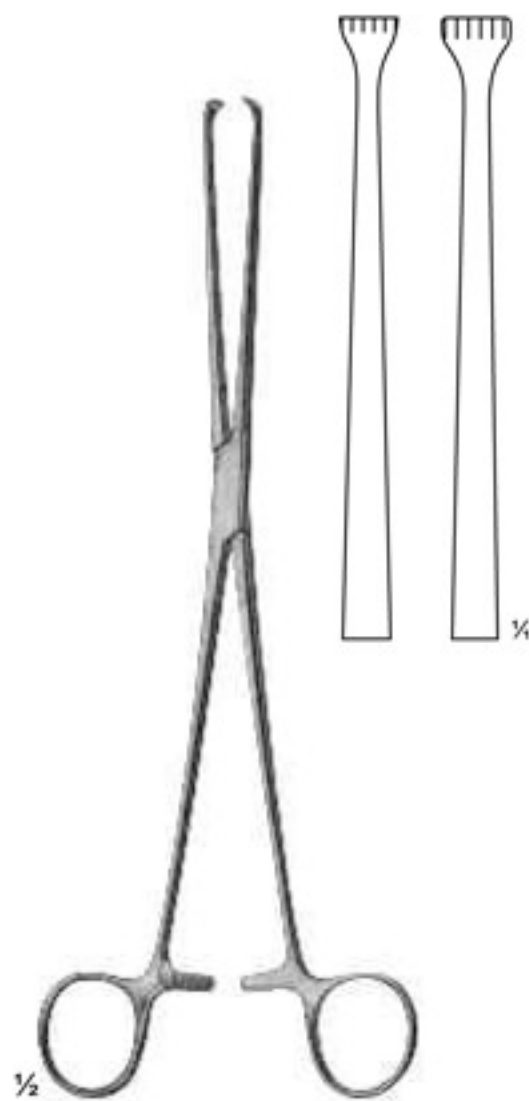

09-106
ALLIS
 190 mm,
09-107
 255 mm,
 5 X 6 teeth



09-108
JUDD-ALLIS
 3 X 4 teeth
 195 mm,

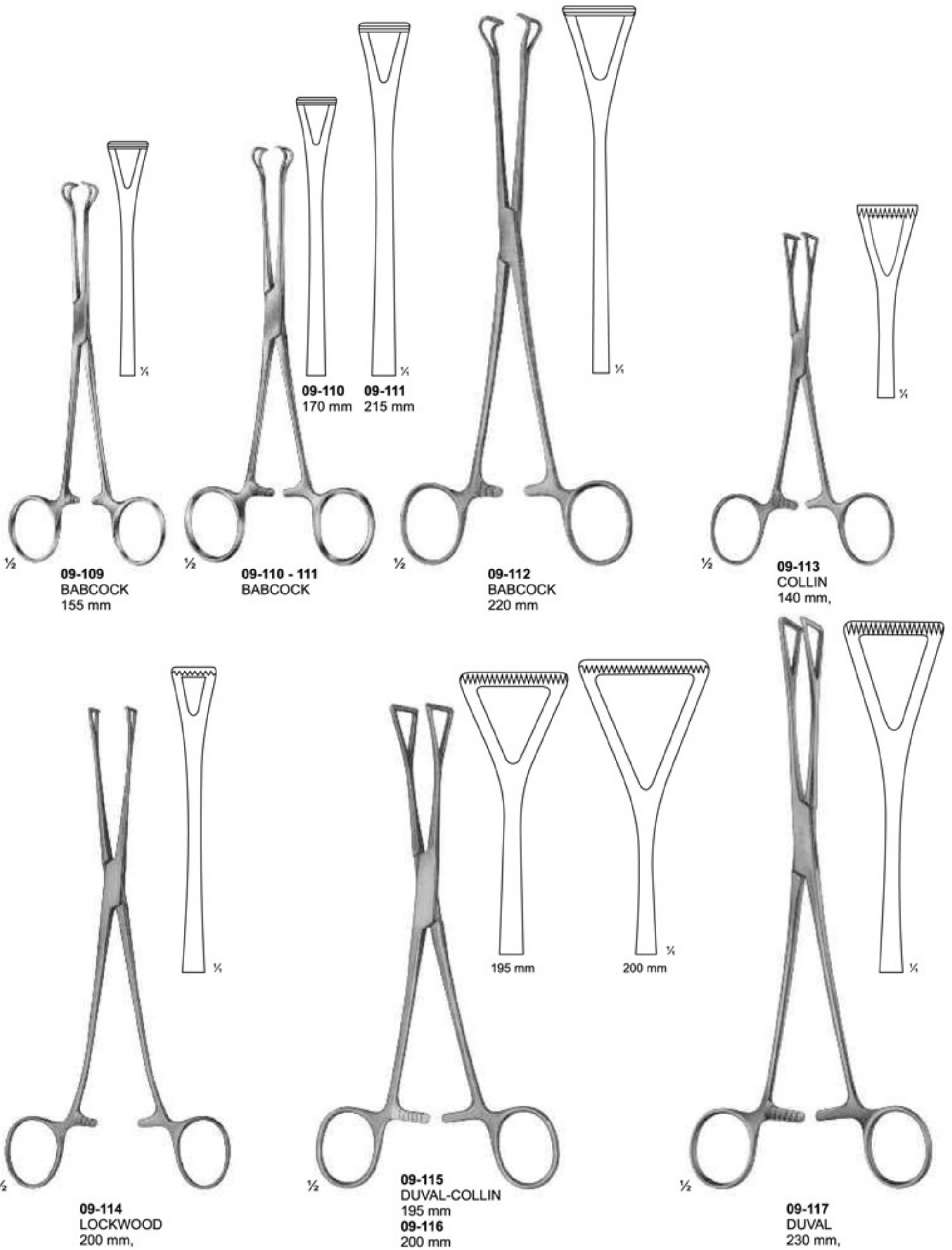

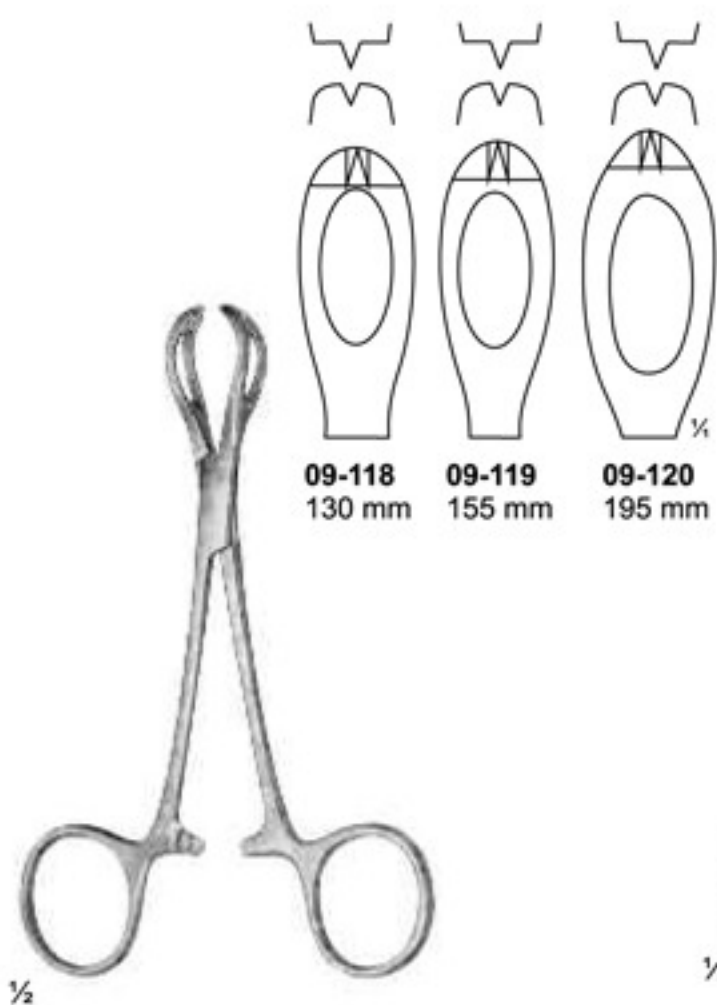

09-118-120
LANE

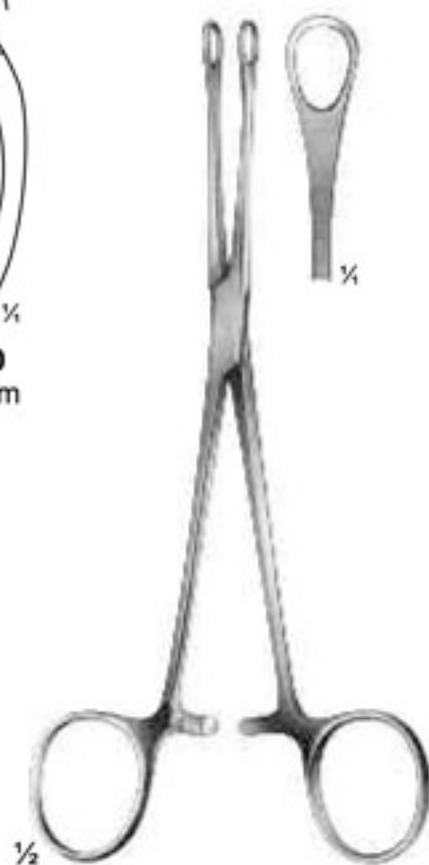

09-121
WILLIAMS
160 mm



09-122
DENIS
BROWNE
190 mm

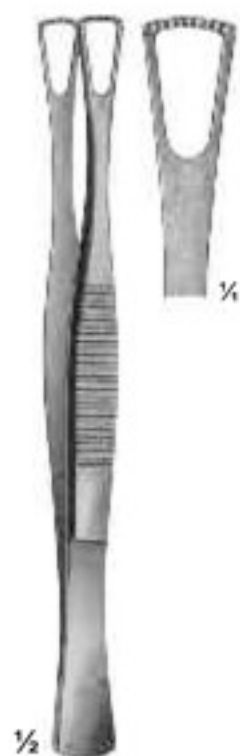

09-123
DUVAL
140 mm



09-124
WANGENSTEEN
150 mm
09-125
230 mm



09-126
WANGENSTEEN
150 mm
09-127
230 mm

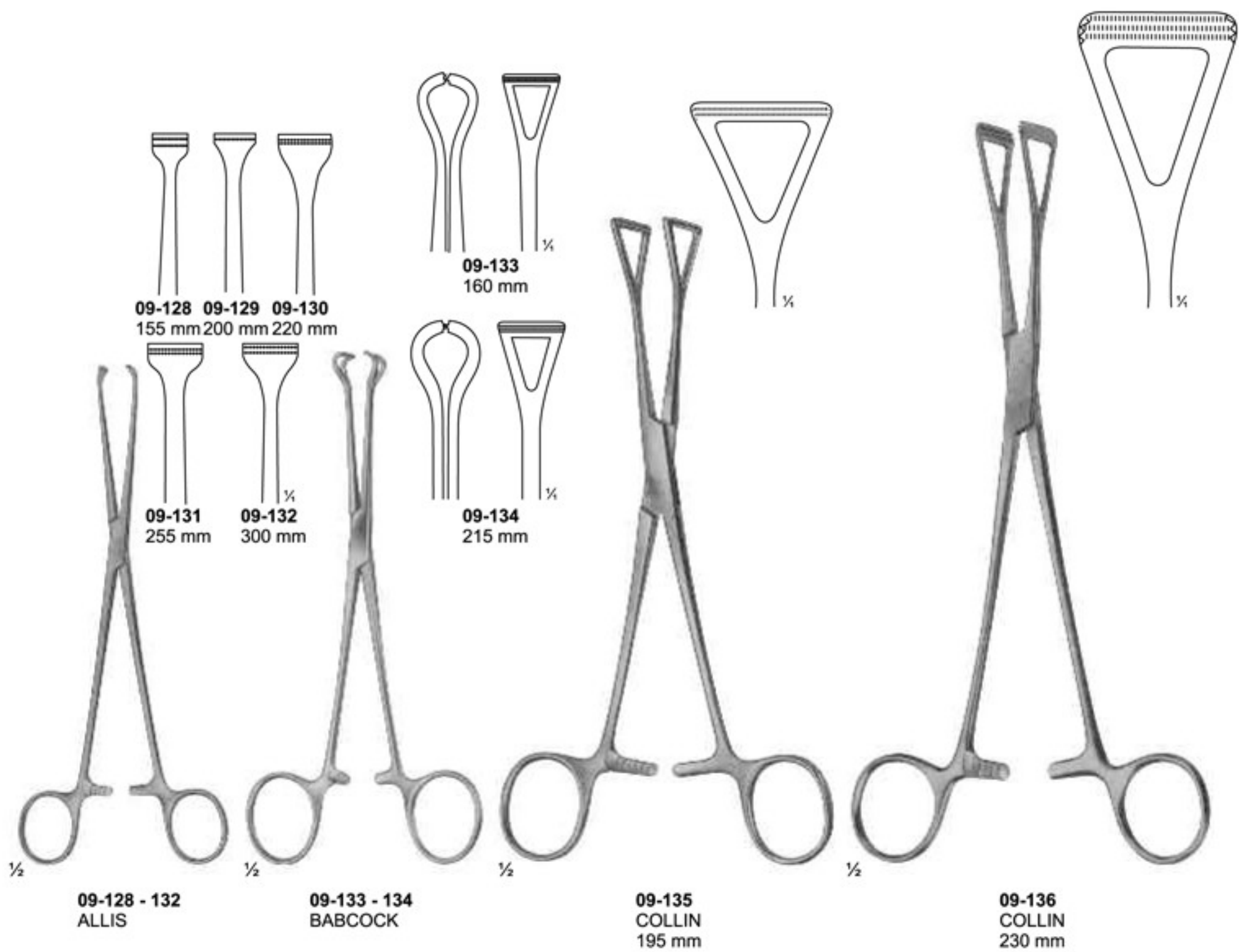

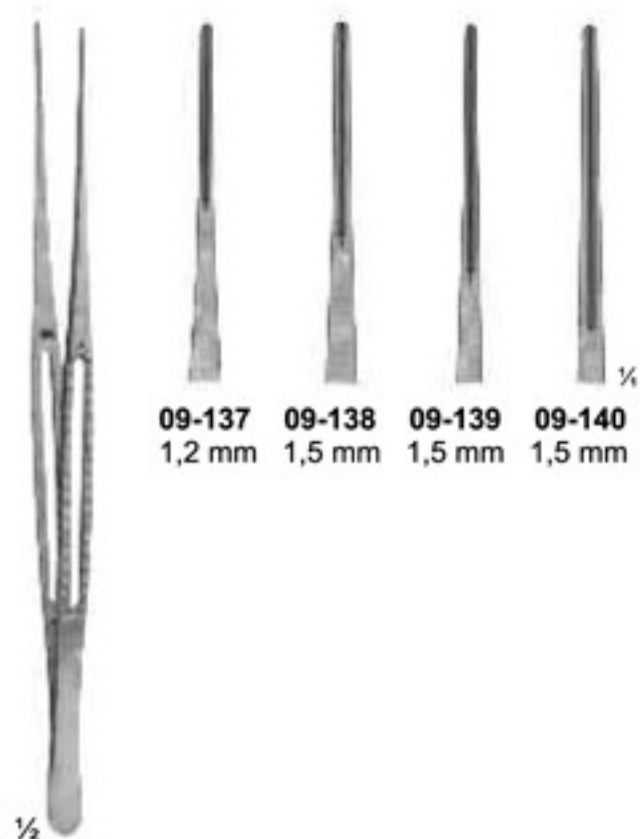

09-137 1,2 mm
09-138 1,5 mm
09-139 1,5 mm
09-140 1,5 mm

09-137 150 mm
09-138 200 mm
09-139 240 mm
09-140 300 mm

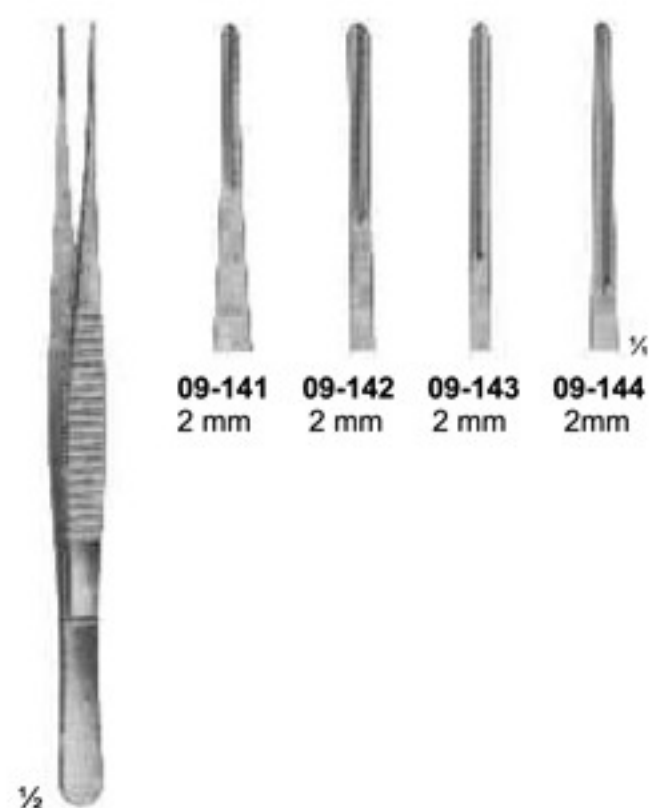

09-141 2 mm
09-142 2 mm
09-143 2 mm
09-144 2mm

DE BAKEY
09-141 150 mm
09-142 200 mm
09-143 240 mm
09-144 300 mm

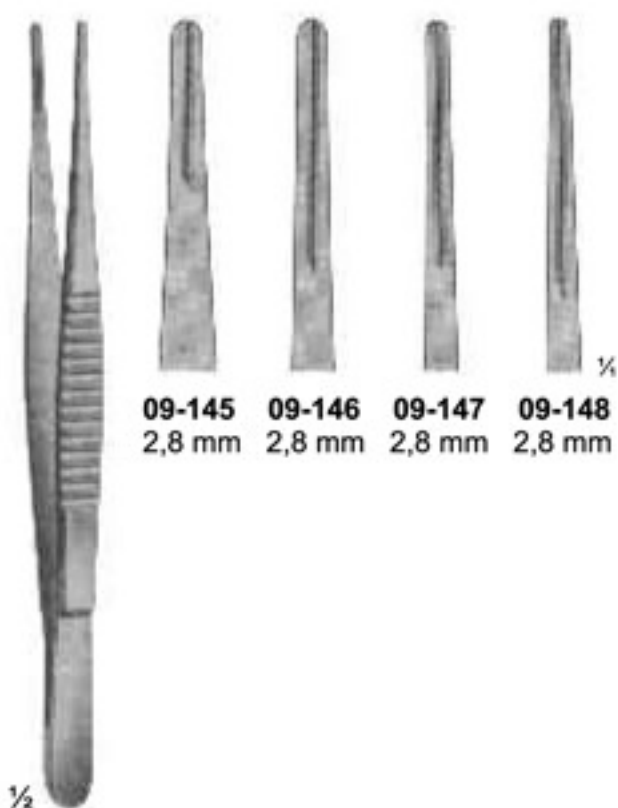

09-145 2,8 mm
09-146 2,8 mm
09-147 2,8 mm
09-148 2,8 mm

DE BAKEY
09-145 150 mm
09-146 200 mm
09-147 240 mm
09-148 300 mm

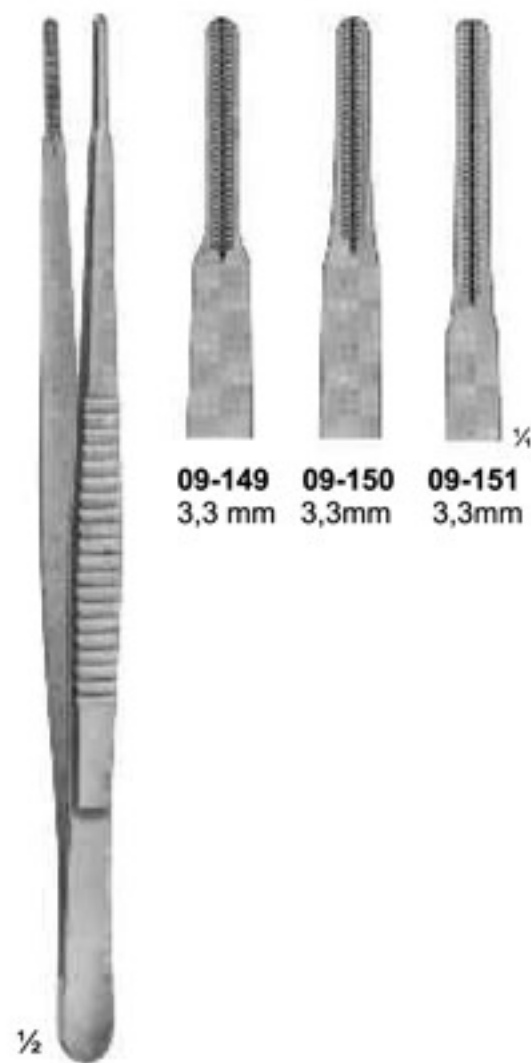

09-149 3,3 mm
09-150 3,3mm
09-151 3,3mm

DE BAKEY
09-149 200 mm
09-150 240 mm
09-151 300 mm

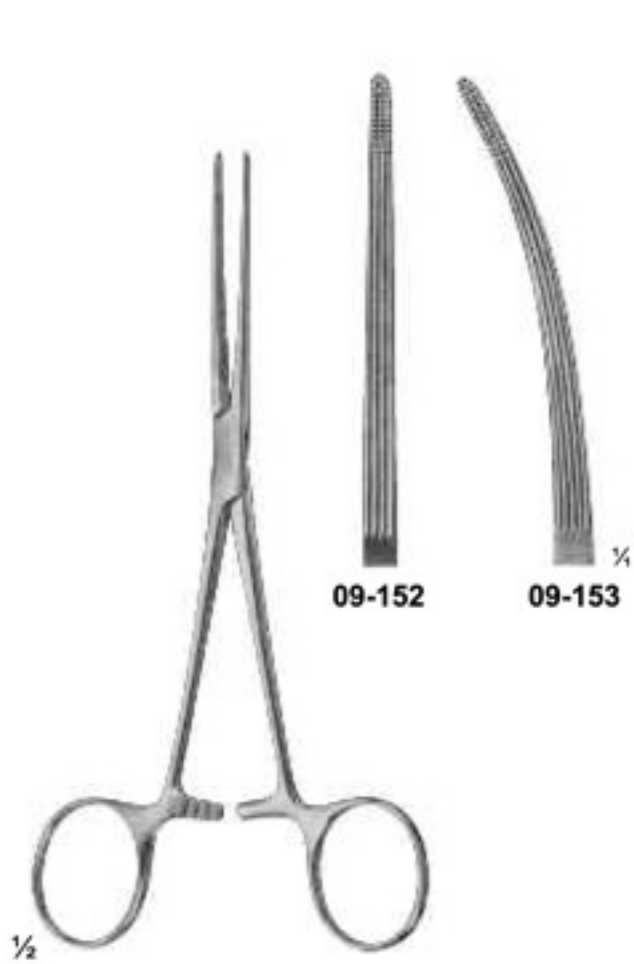

09-152 - 153
BAINBRIDGE
155 mm

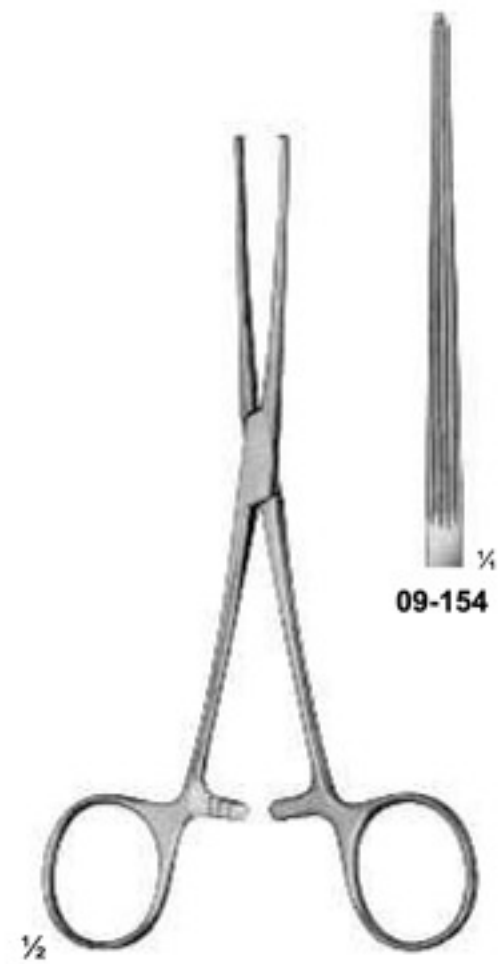

09-154
ALLEN
155 mm

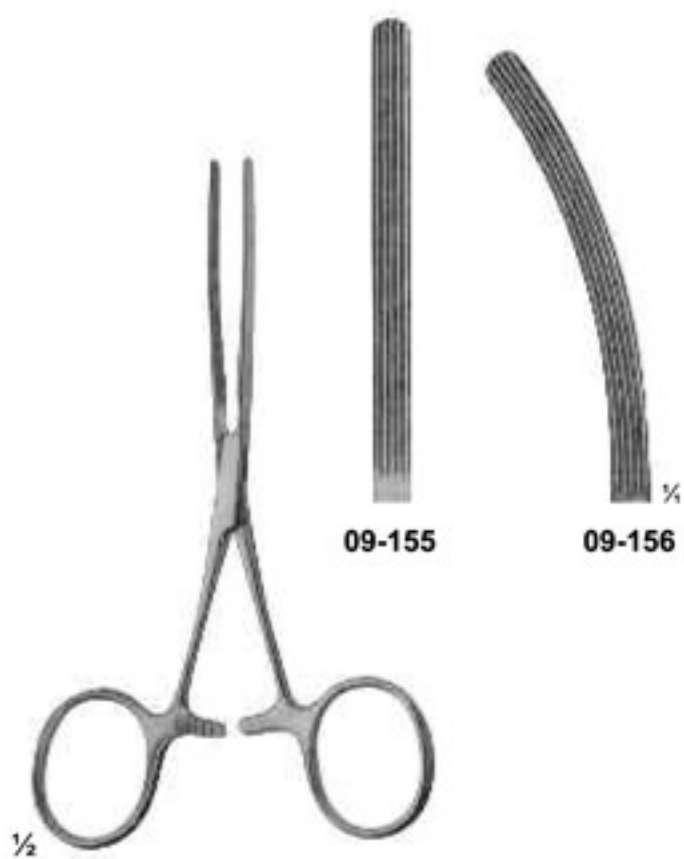

09-155 - 156
BABY-KOCHER
very elastic blades
130 mm

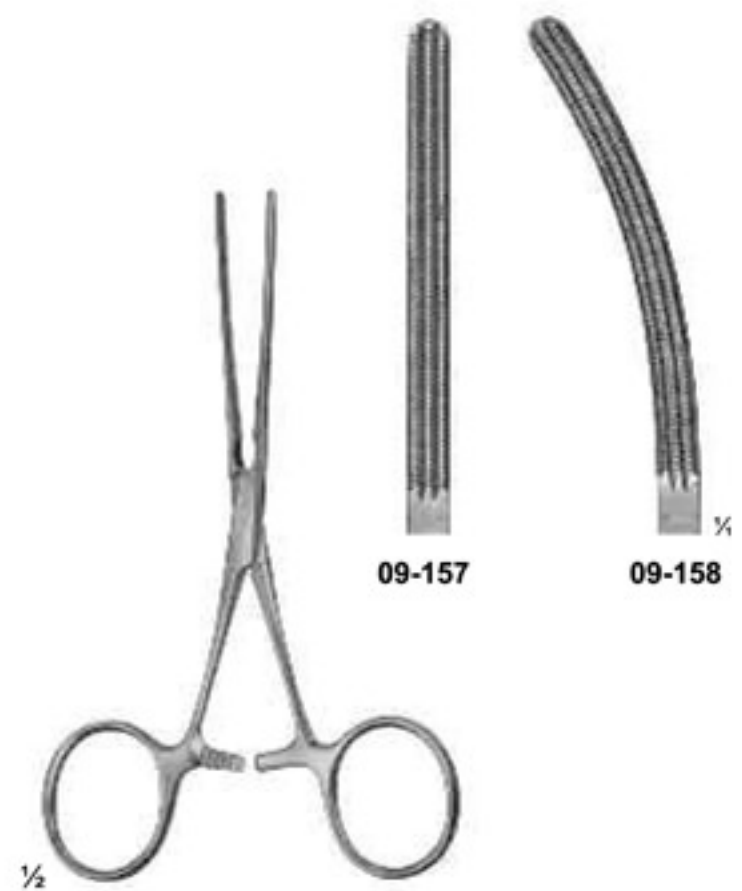

09-157 - 158
BABY-KOCHER
with elastic blades
130 mm

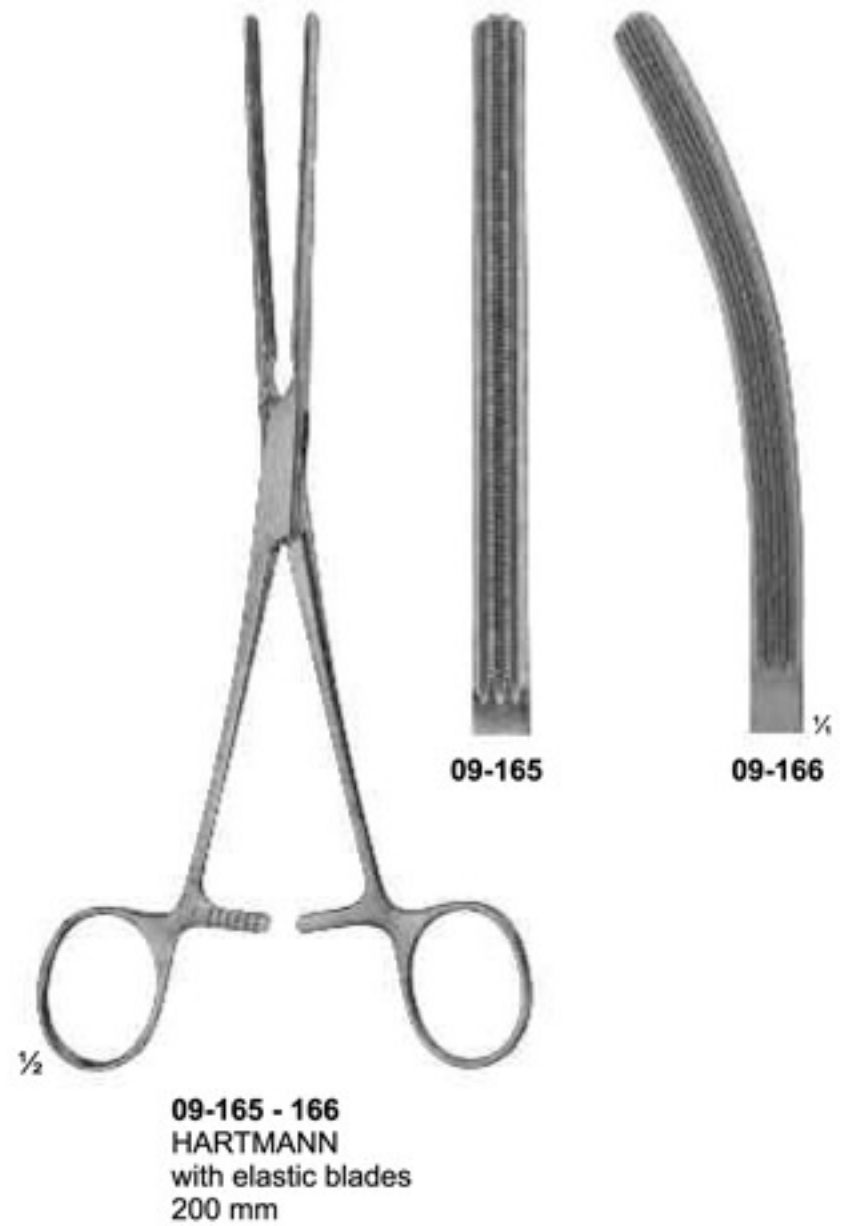
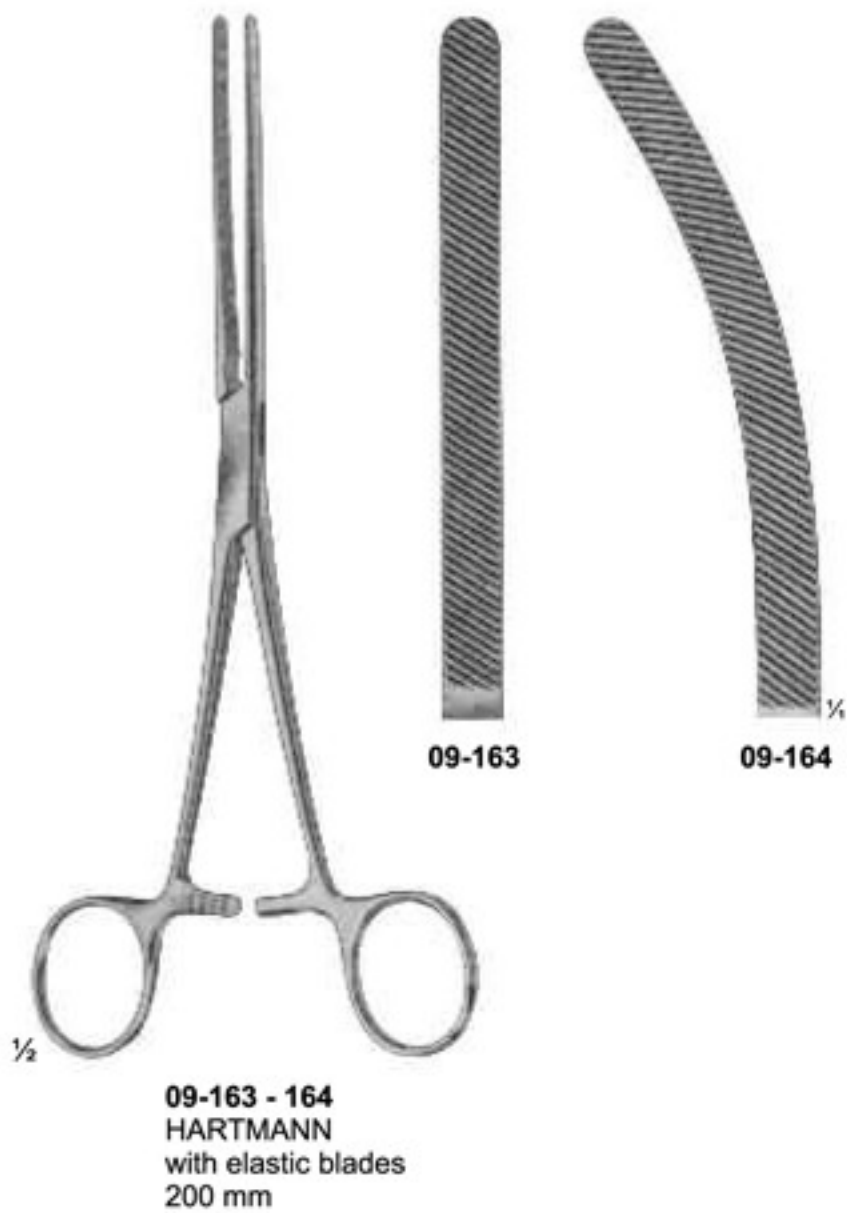
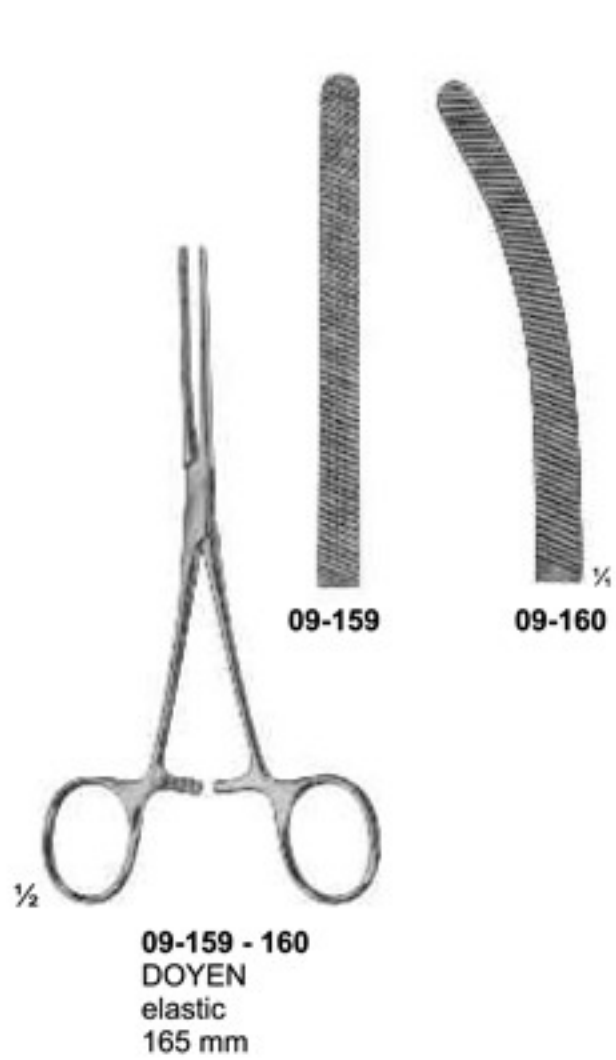

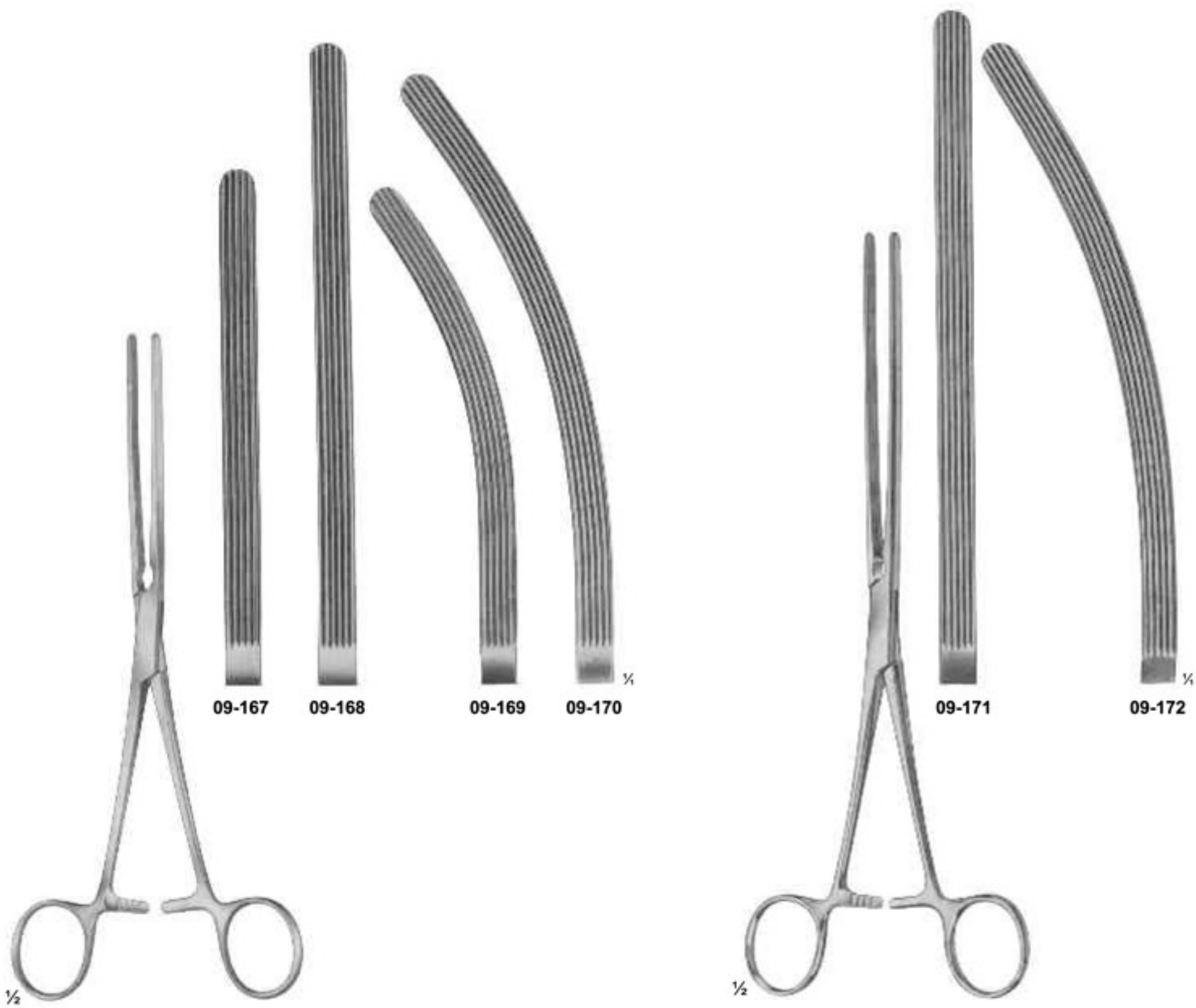

09-167 - 170
KOCHER
 with elastic blades
09-169 210 mm
09-170 230 mm

09-171 - 172
DOYEN
 with elastic blades
 210 mm

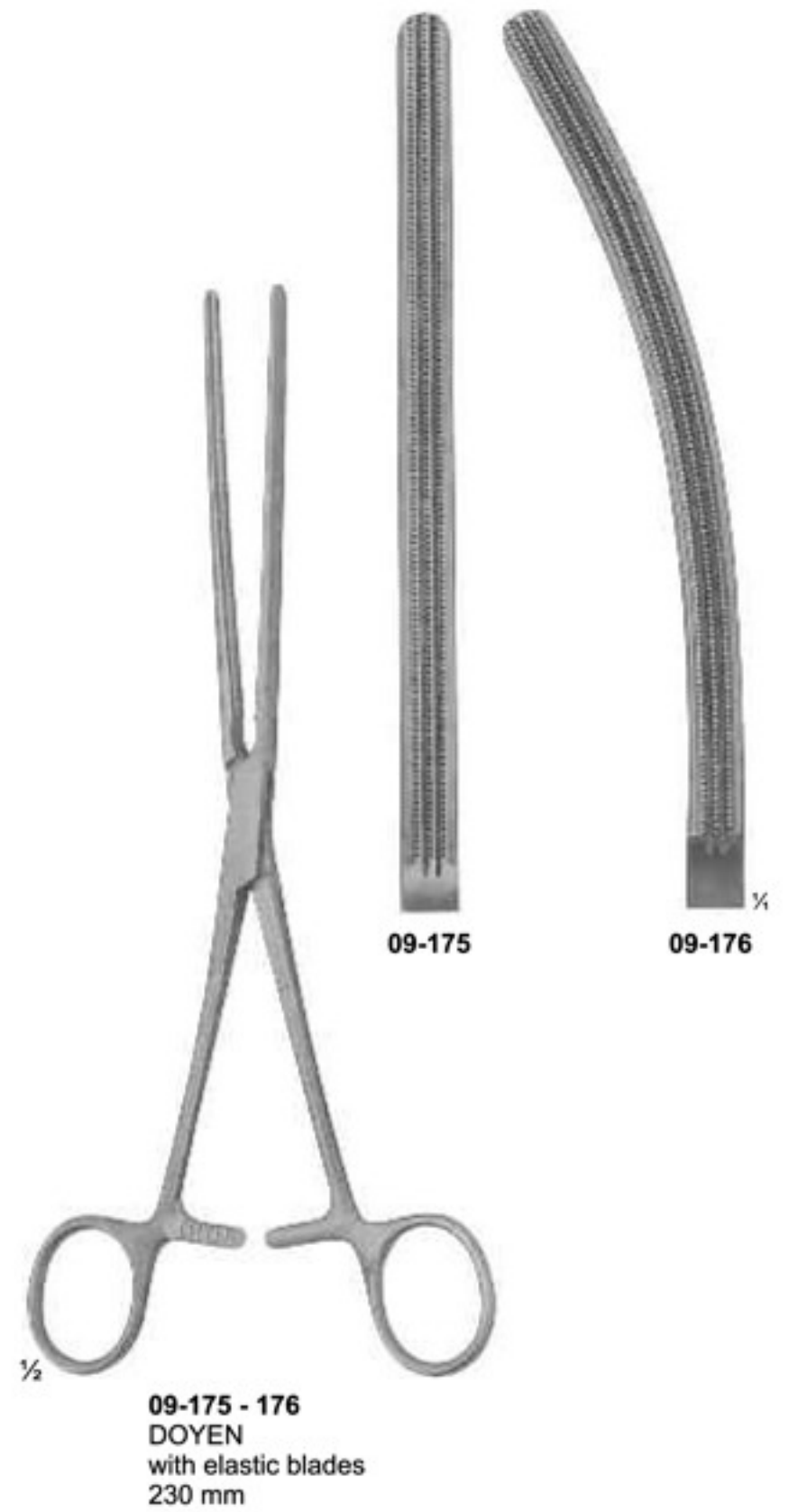
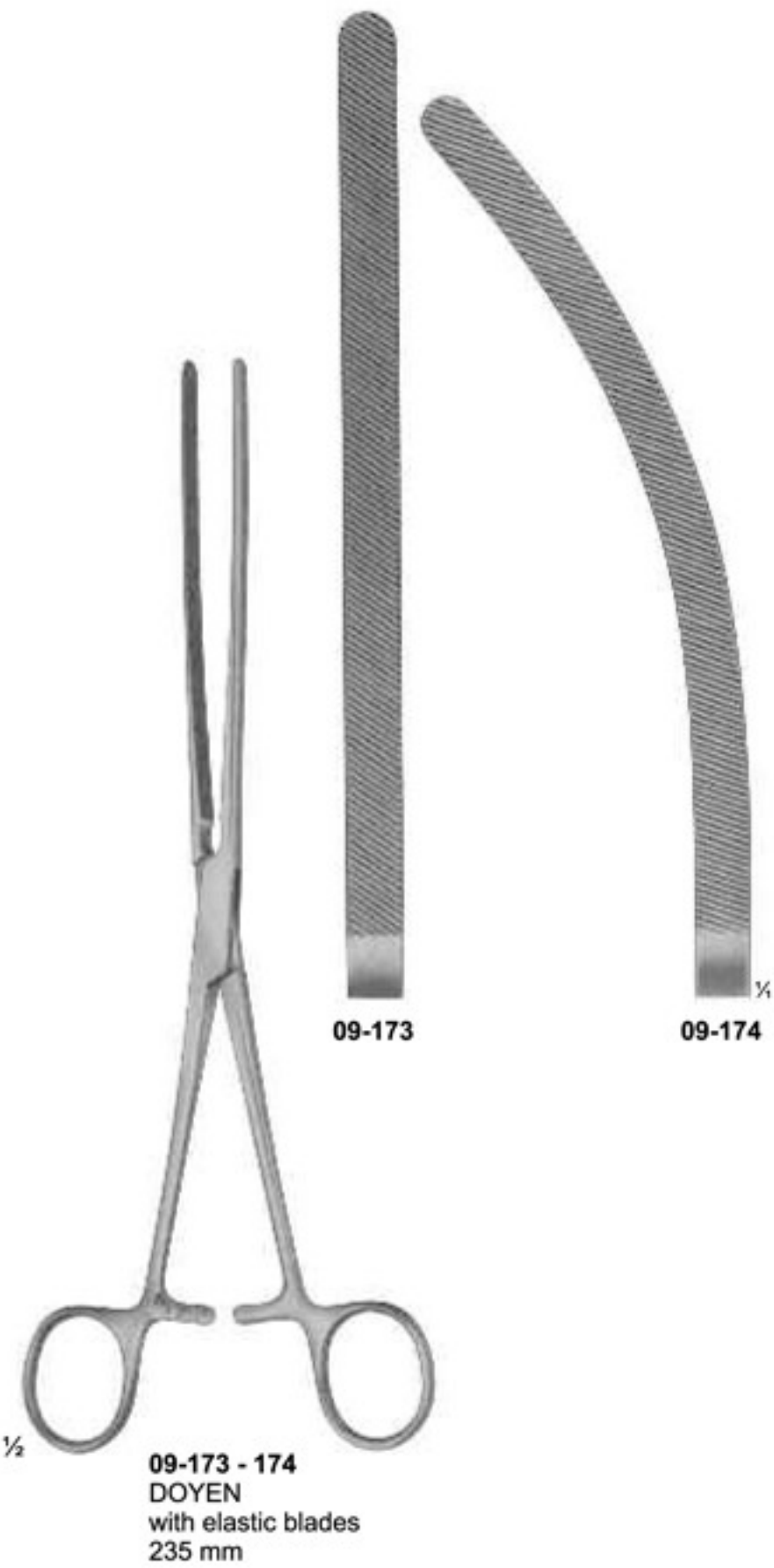

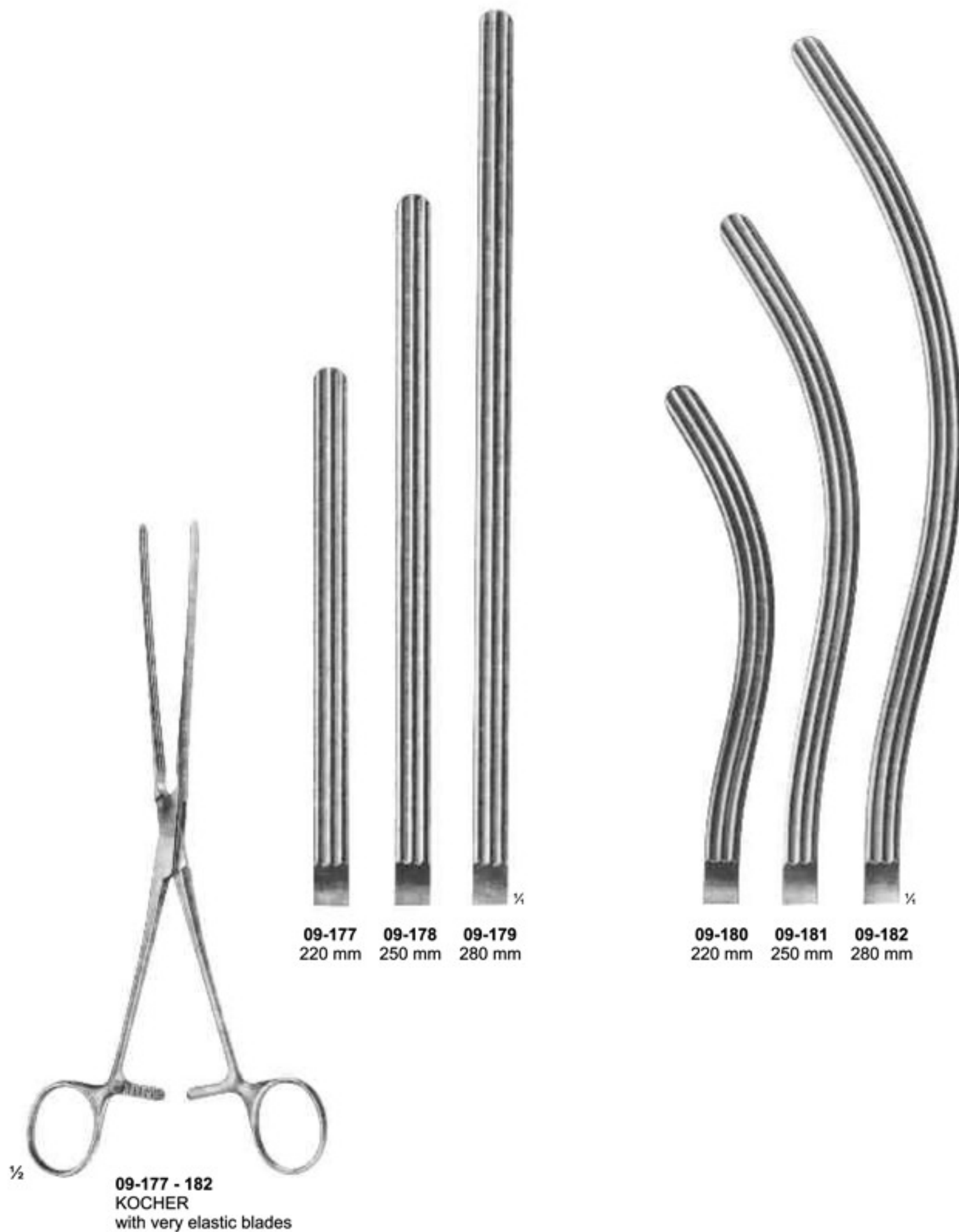

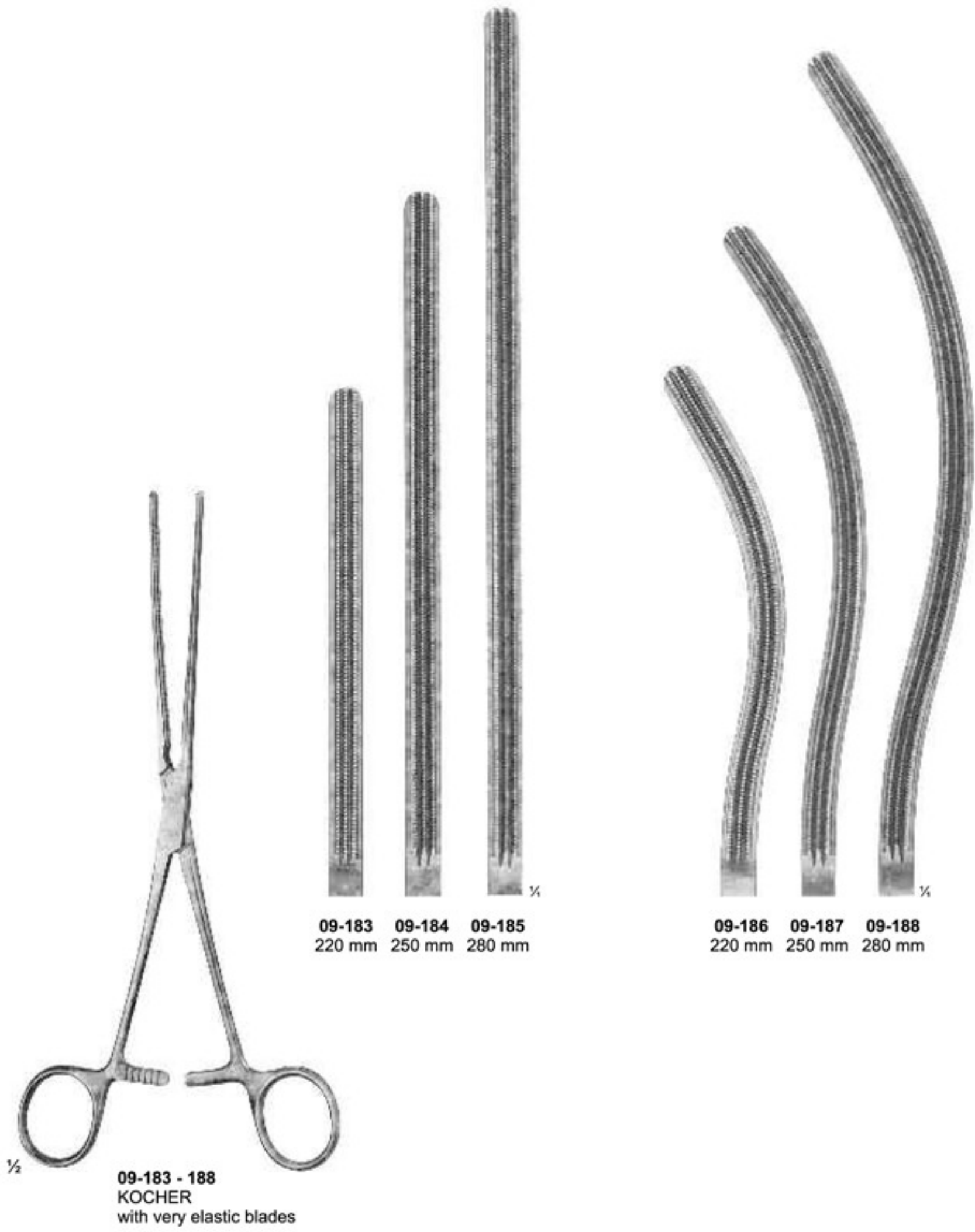



09-189

09-190

09-191

09-189 - 190
NUSSBAUM
with elastic blades
250 mm

09-191
MOYNIHAN
280 mm

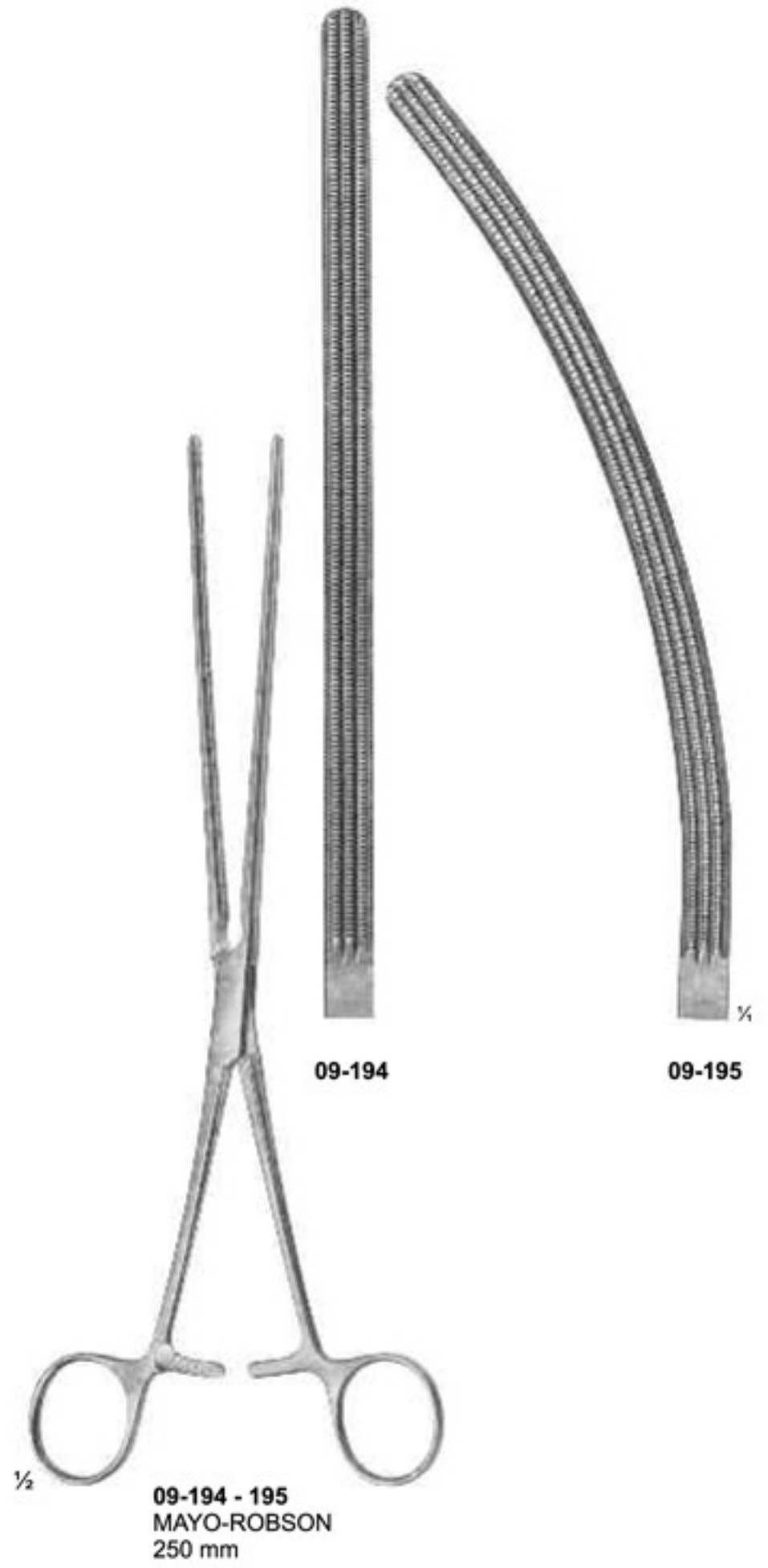
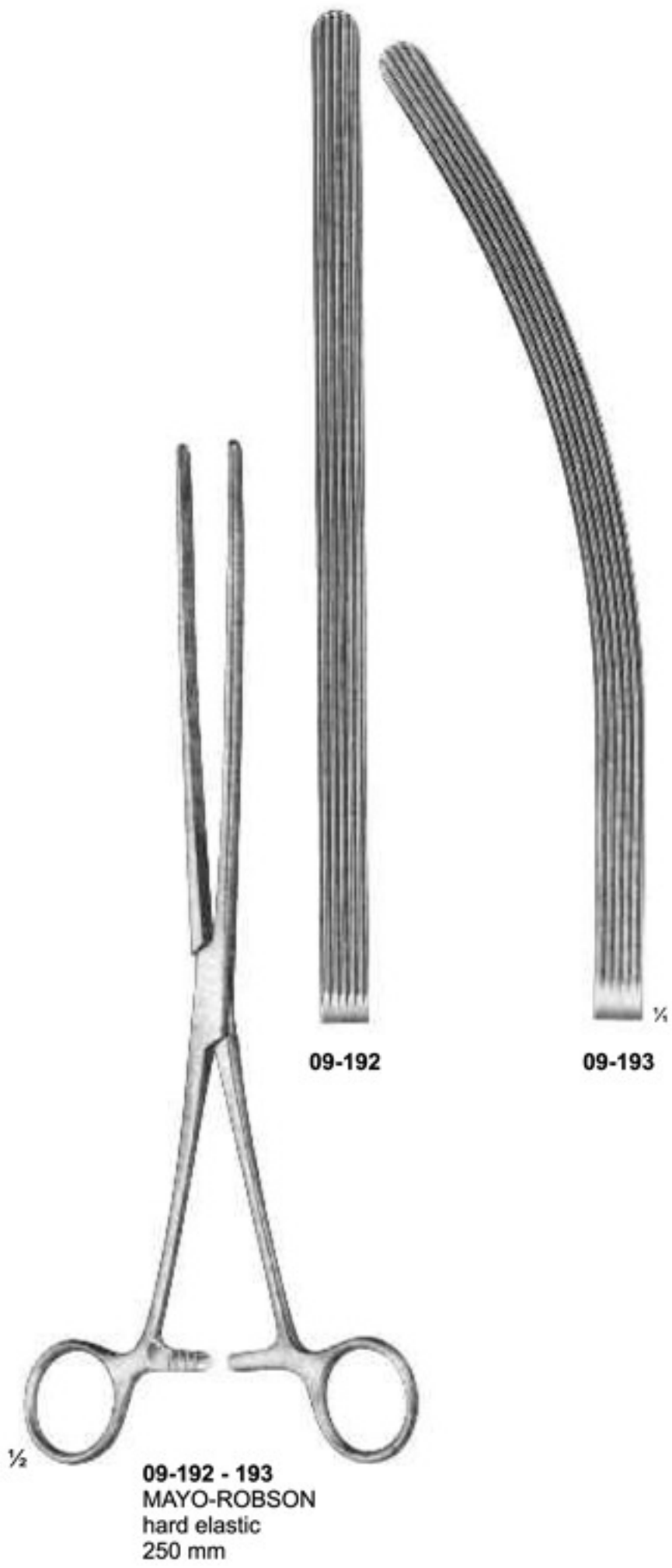



09-196
LANE
300 mm

09-197
LANE
300 mm

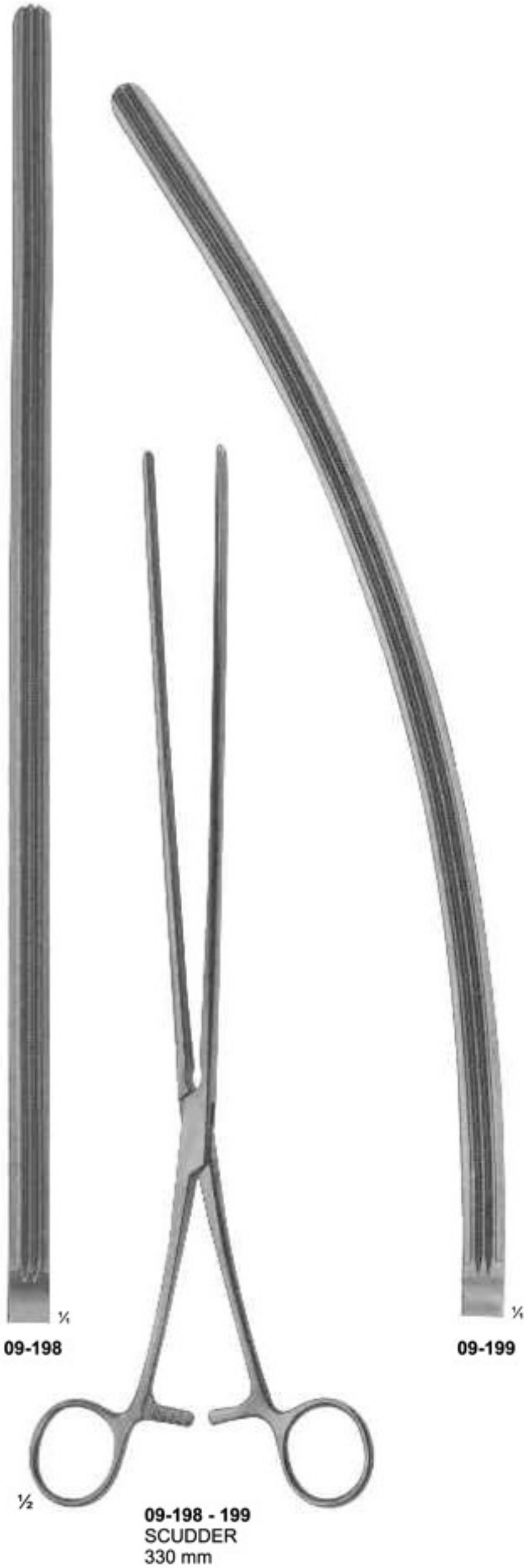



09-201
PAYR
 Intestinal clamp
 light pattern,
 for children
 180 mm

09-202
PAYR
 200 mm

09-203
PAYR
 275 mm

09-204
PAYR
 Pylorus clamp
 315 mm

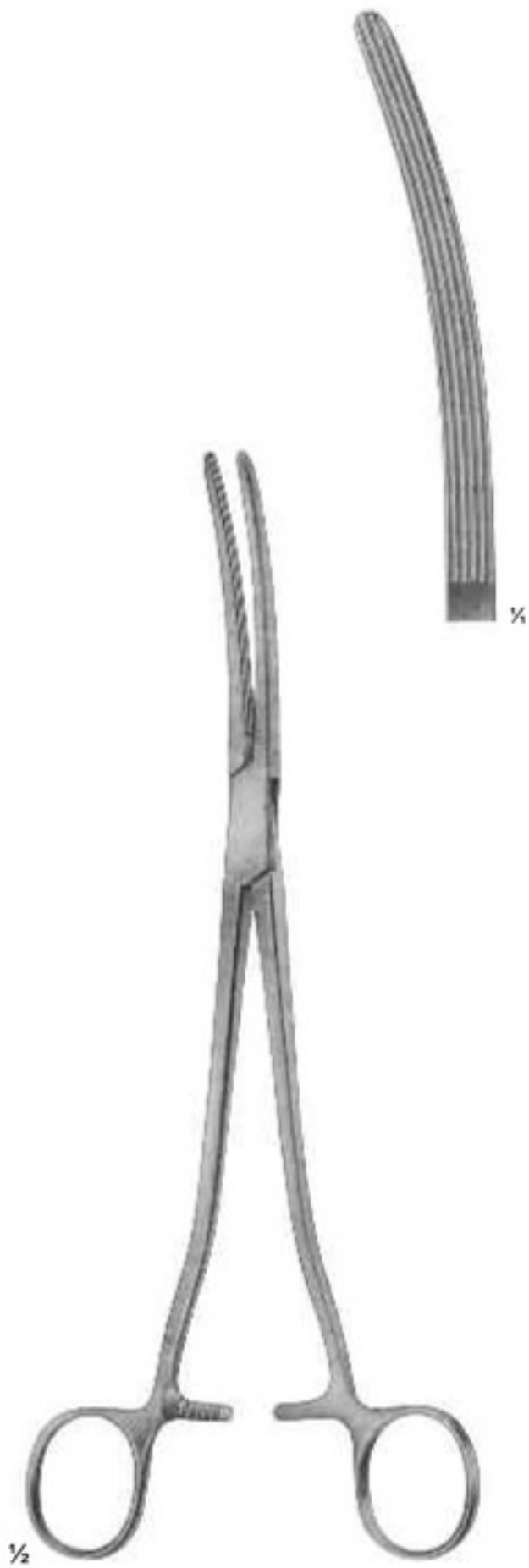

09-205
PARKER-KERR
anastomosis forceps
for colon resection
180 mm

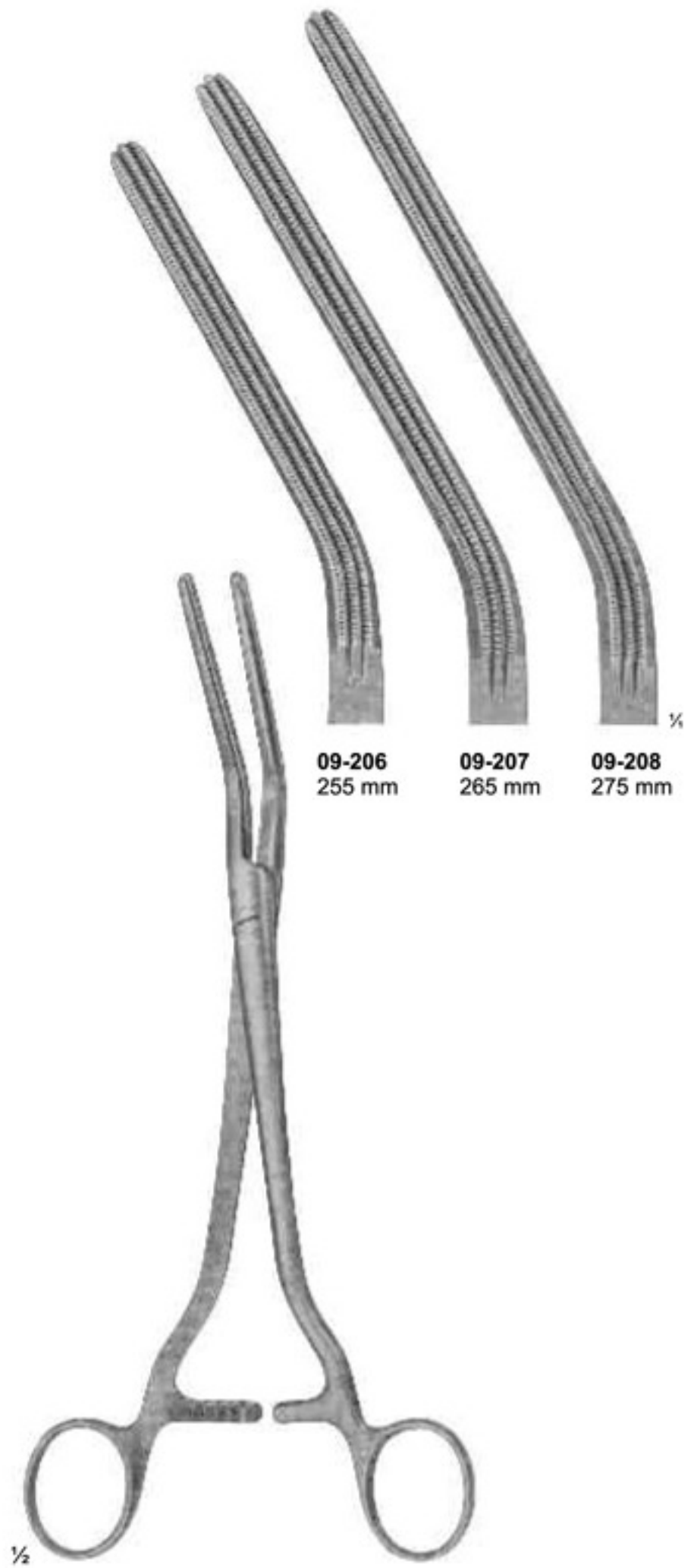

09-206 - 208
DICK
pressure clamps
180 mm



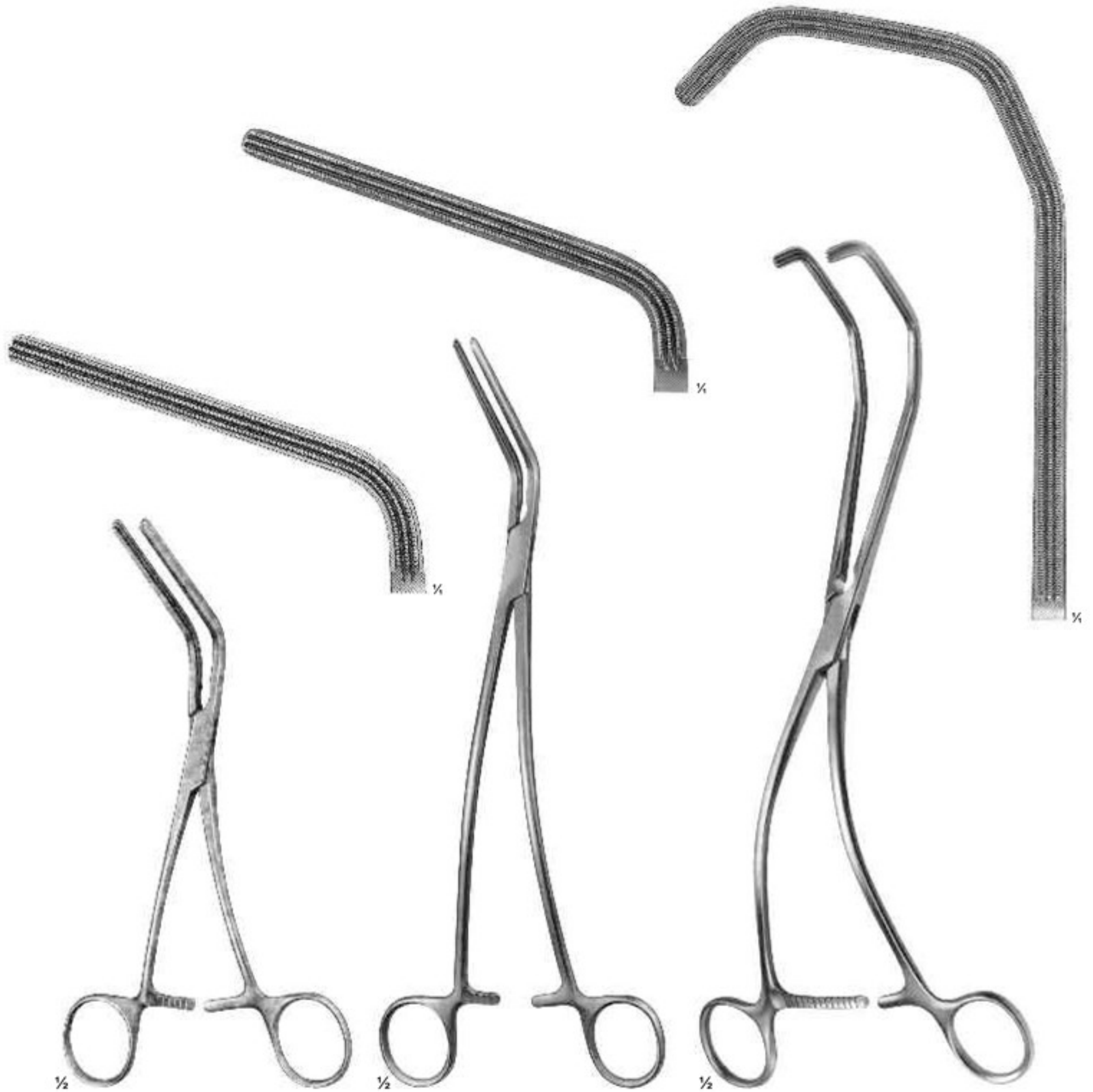

09-212
MORRIS
175 mm

09-213
DE BAKEY
(MORRIS modif.)
240 mm

09-214
KERSTING
270 mm

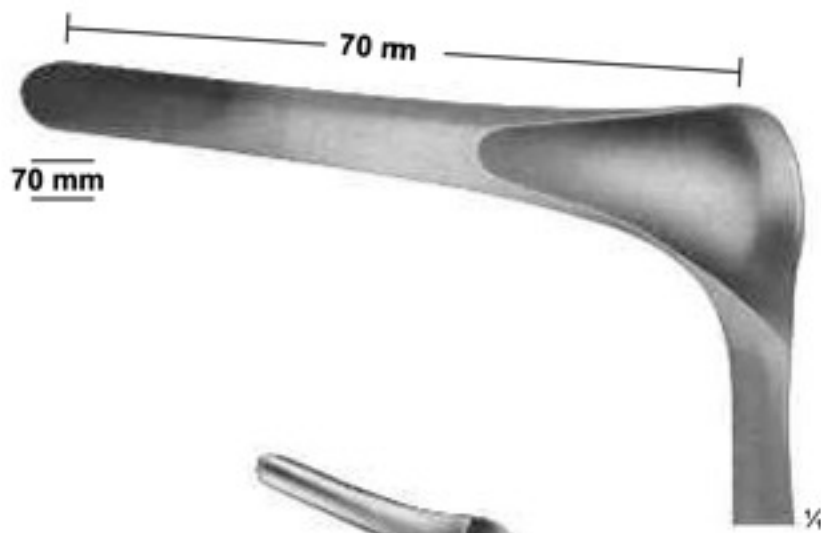

10-101
KILLIAN
for children
145 mm



10-102
SIMS
160 mm



10-103
SIMS
160 mm

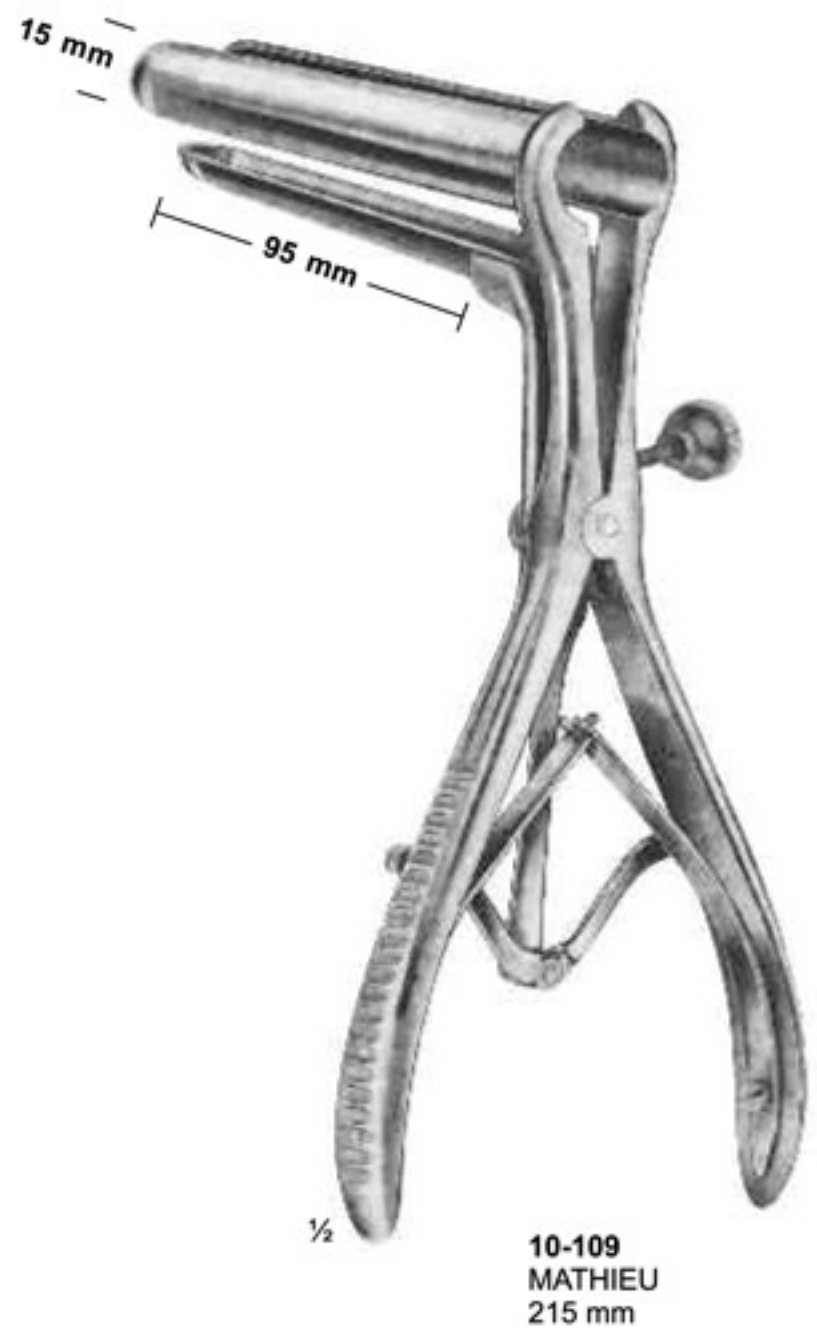
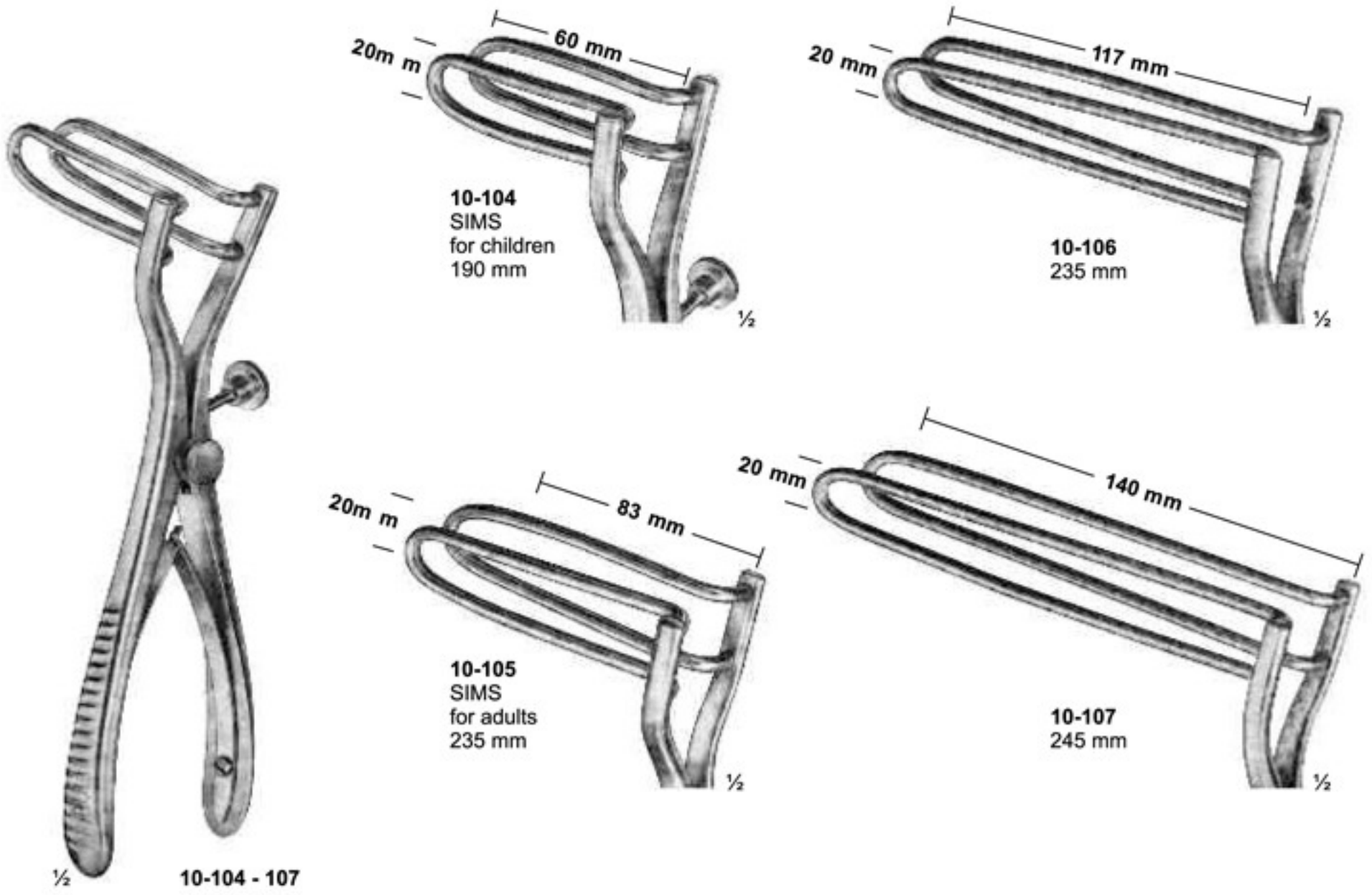



1/2
10-110
IVES-FANSLER
Anuscops
145 mm

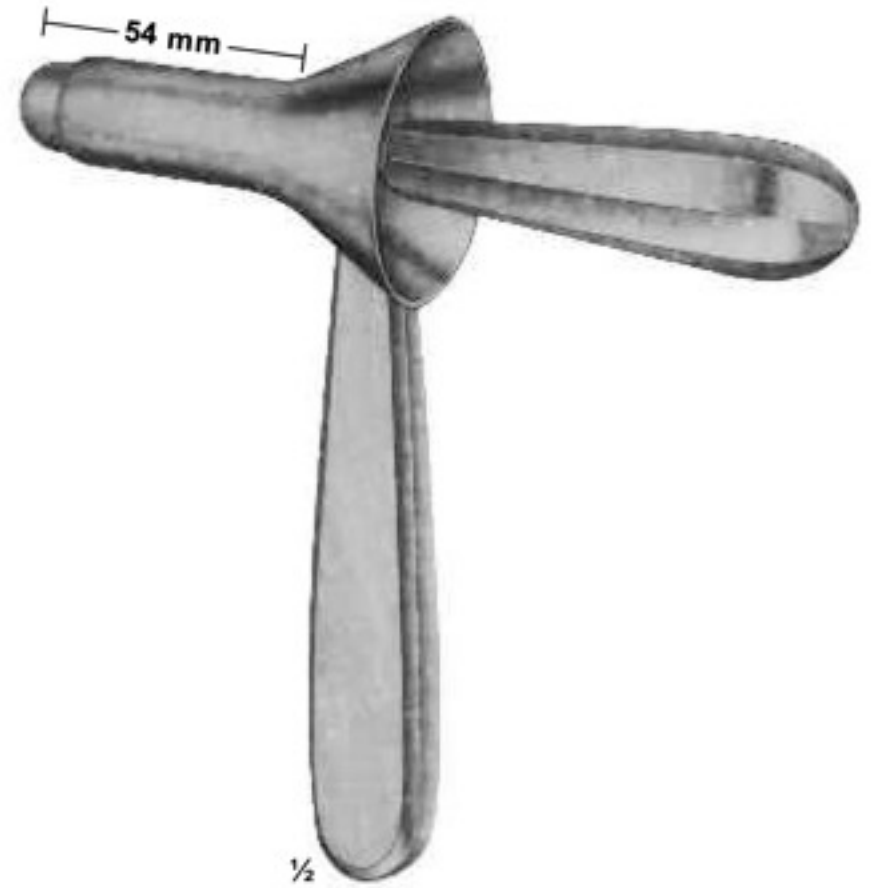

1/2
10-111
KELLY
Sphincteroscope
160 mm

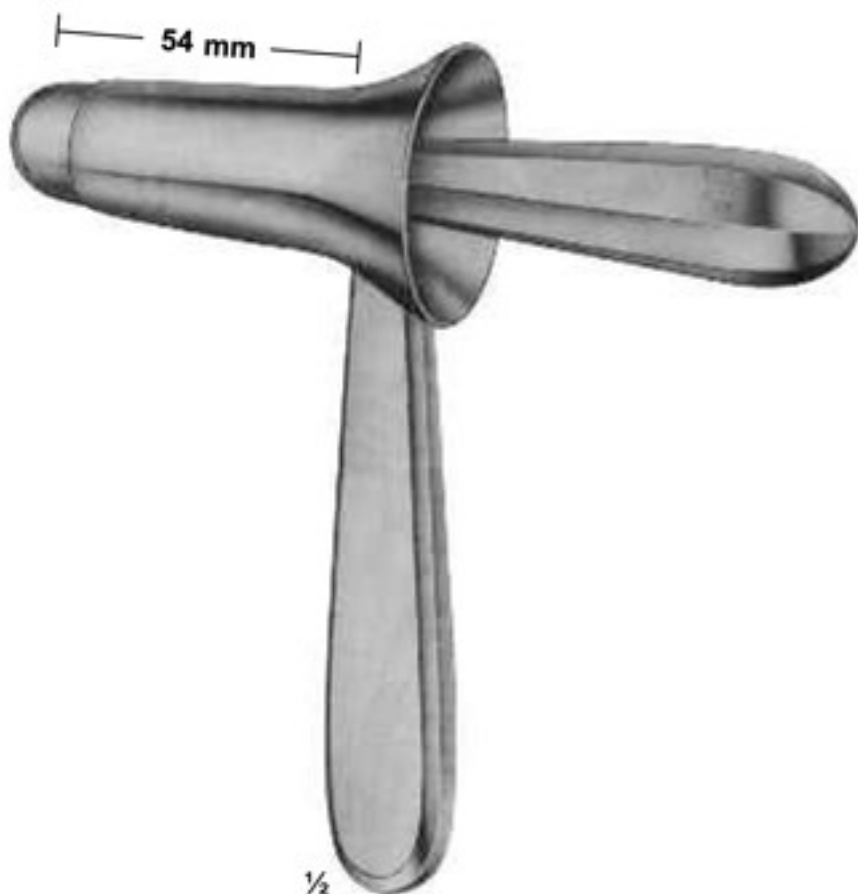

1/2
10-112
KELLY
Sphincteroscope
160 mm

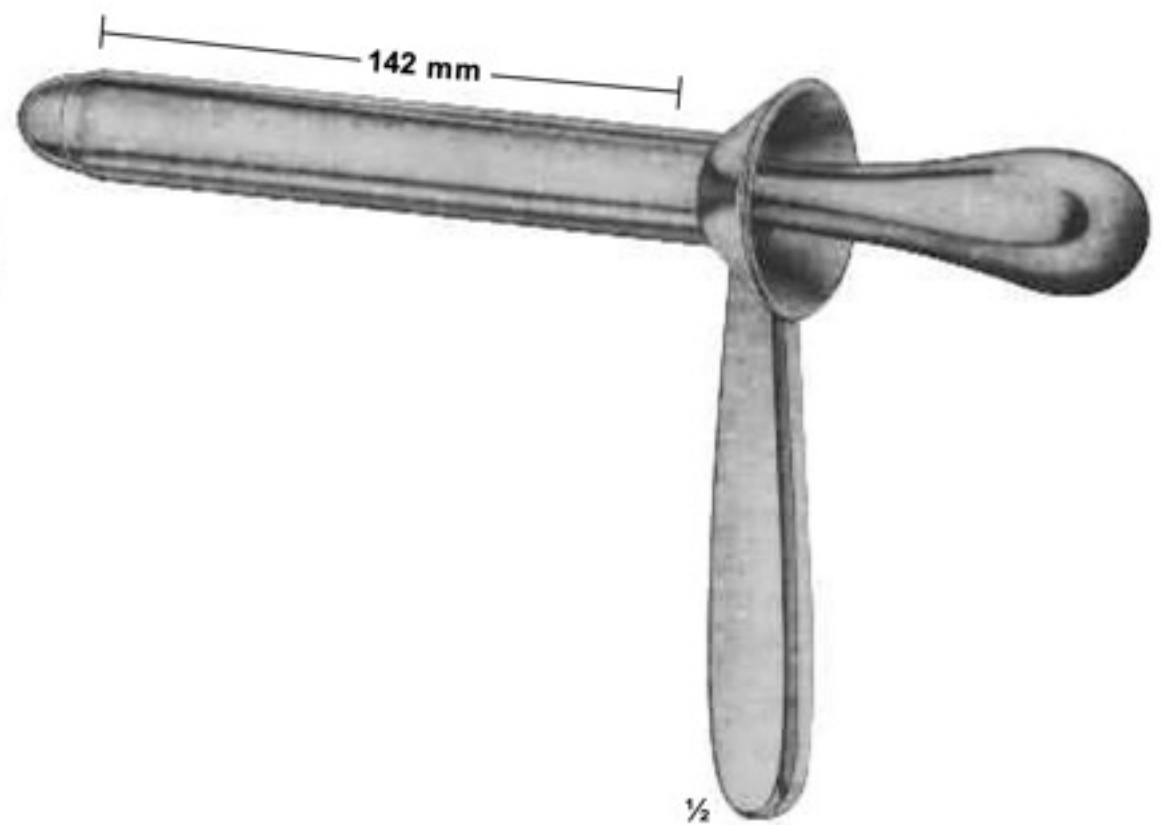

1/2
10-113
KELLY
Proctoscope
160 mm

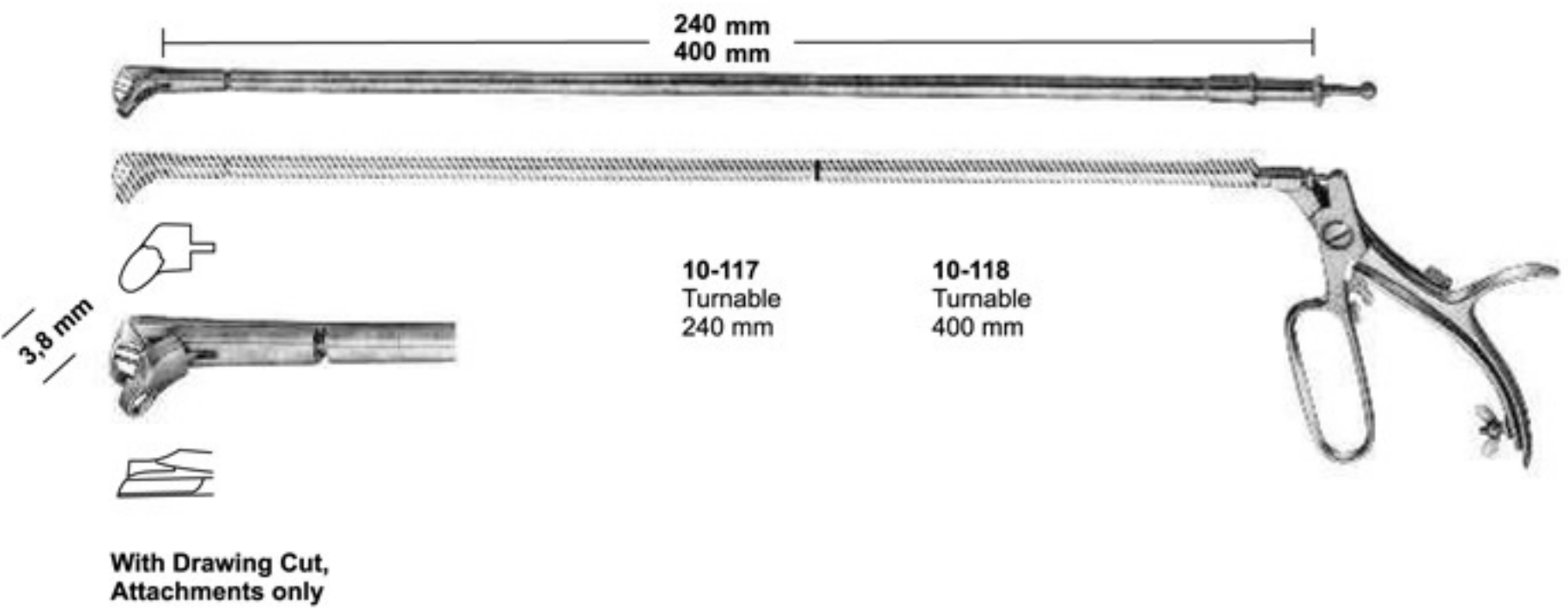
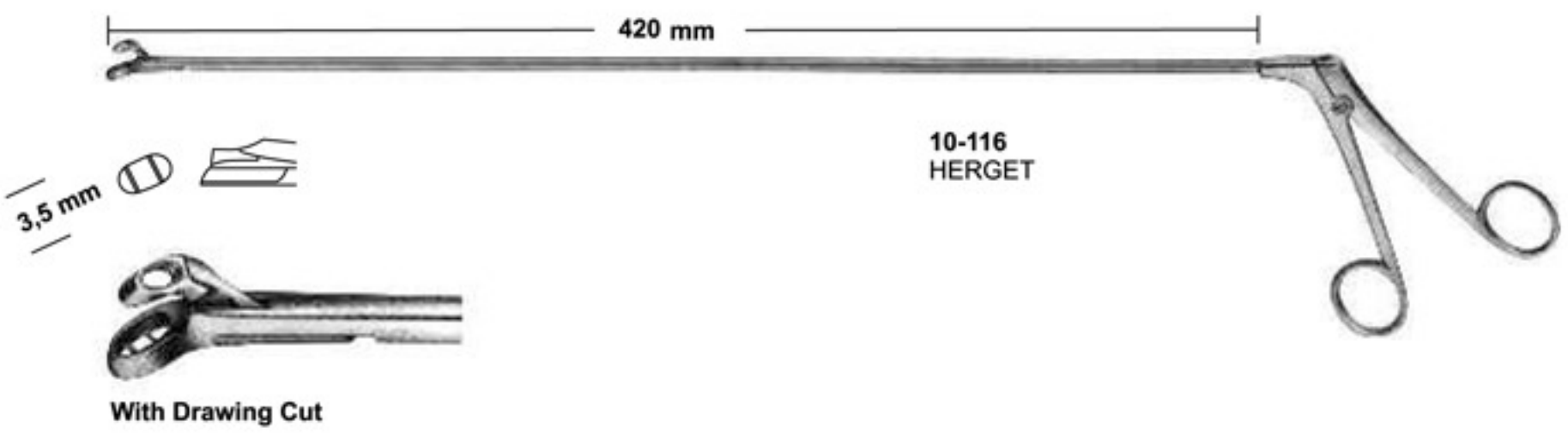
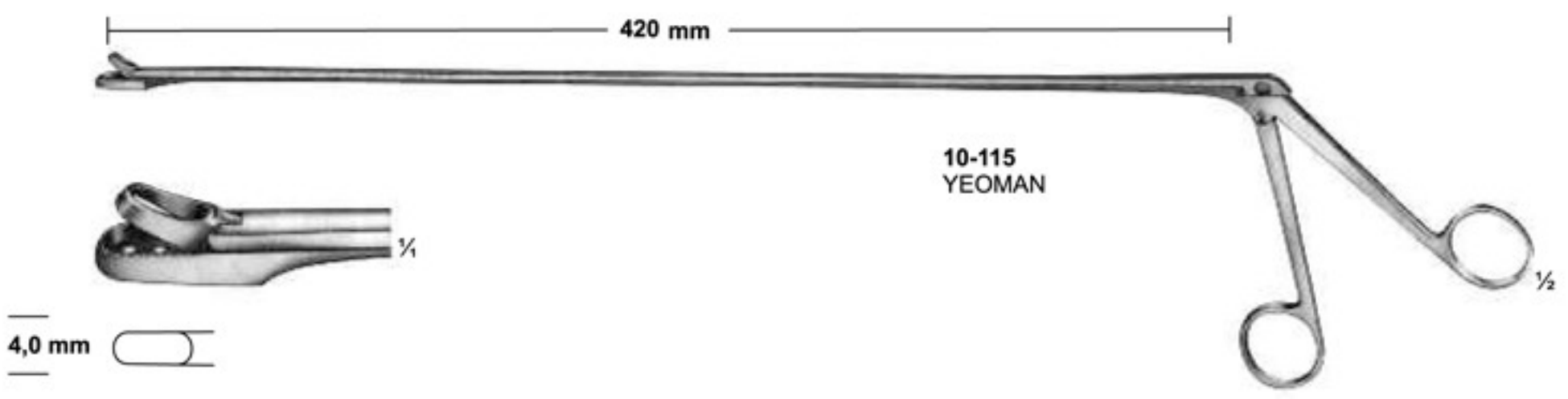
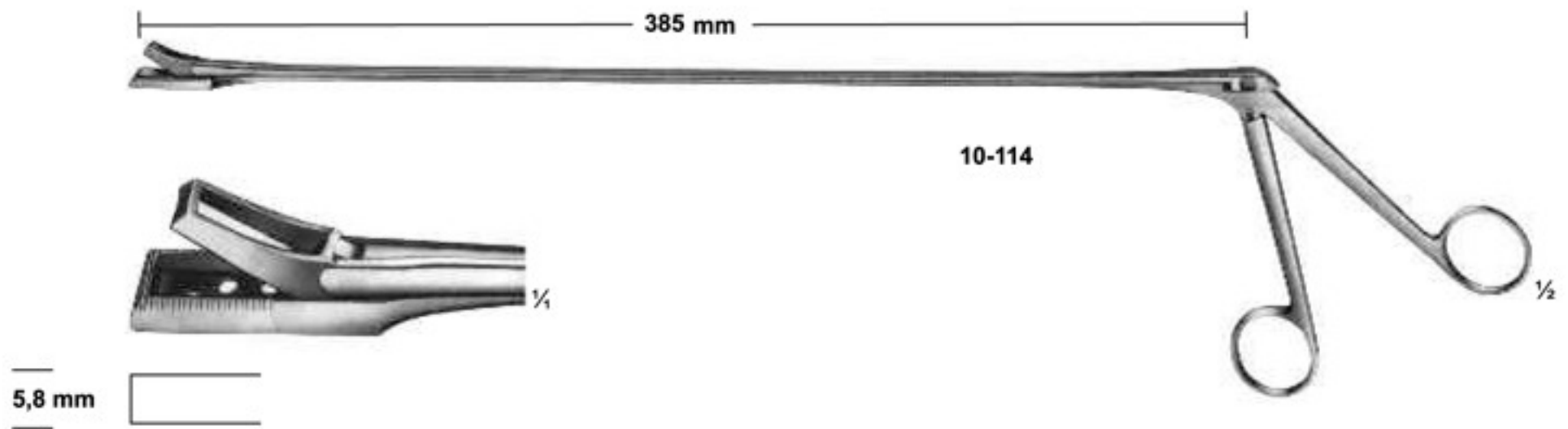

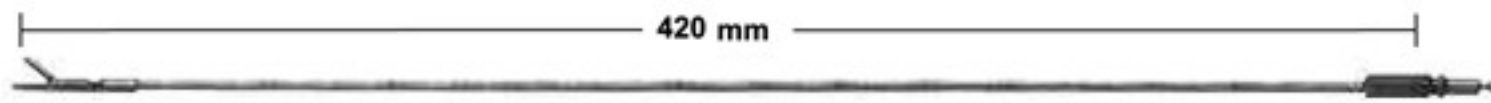

3,5 mm



10-119

3,5 mm



10-120

4,0 mm



10-121

4,0 mm



10-122



10-119 - 122
Handle for 119 - 120 - 121 - 122

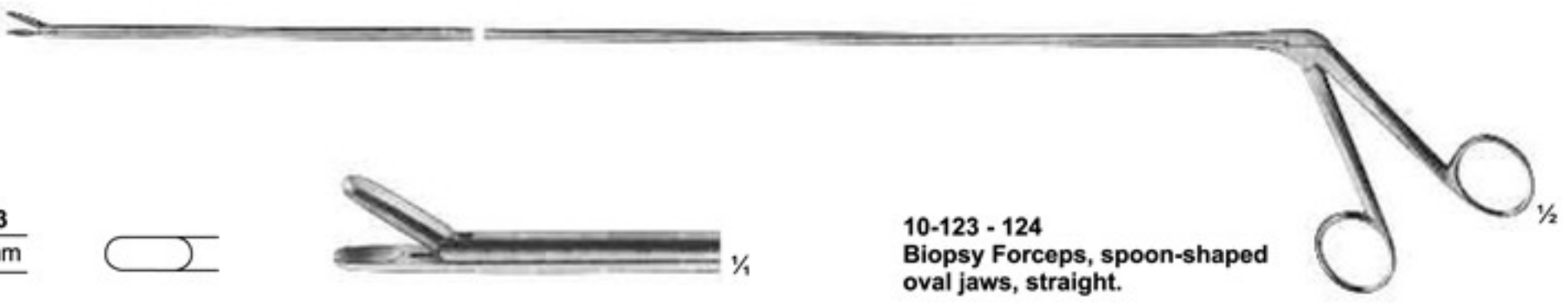

10-123
3,5 mm



10-123 - 124
Biopsy Forceps, spoon-shaped oval jaws, straight.

10-124
4, mm

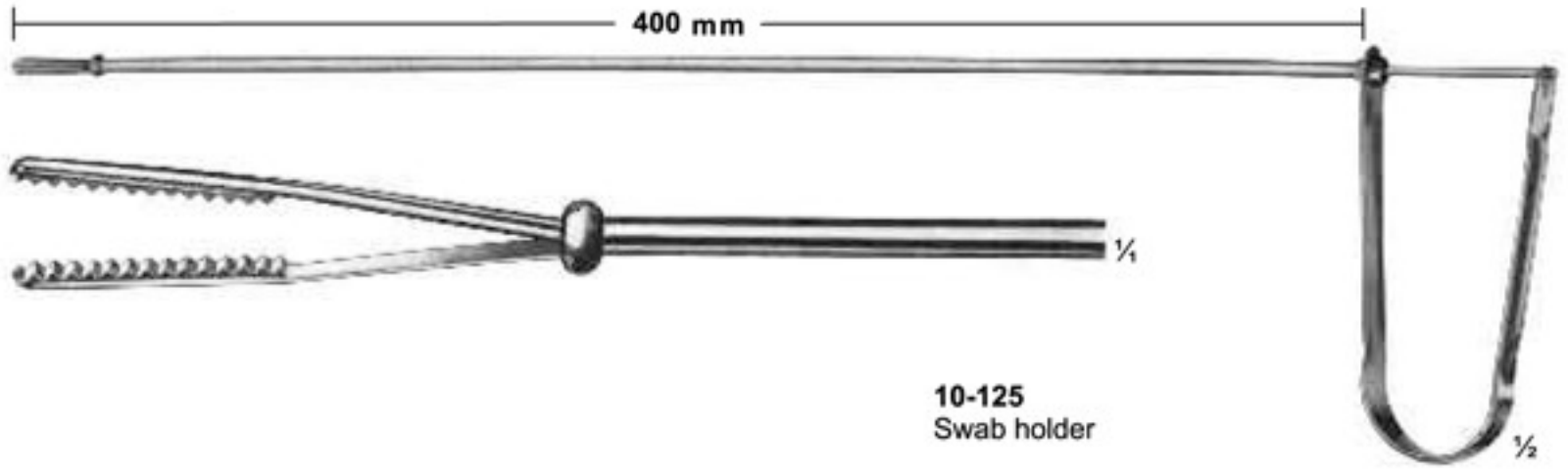
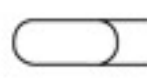

10-125
Swab holder

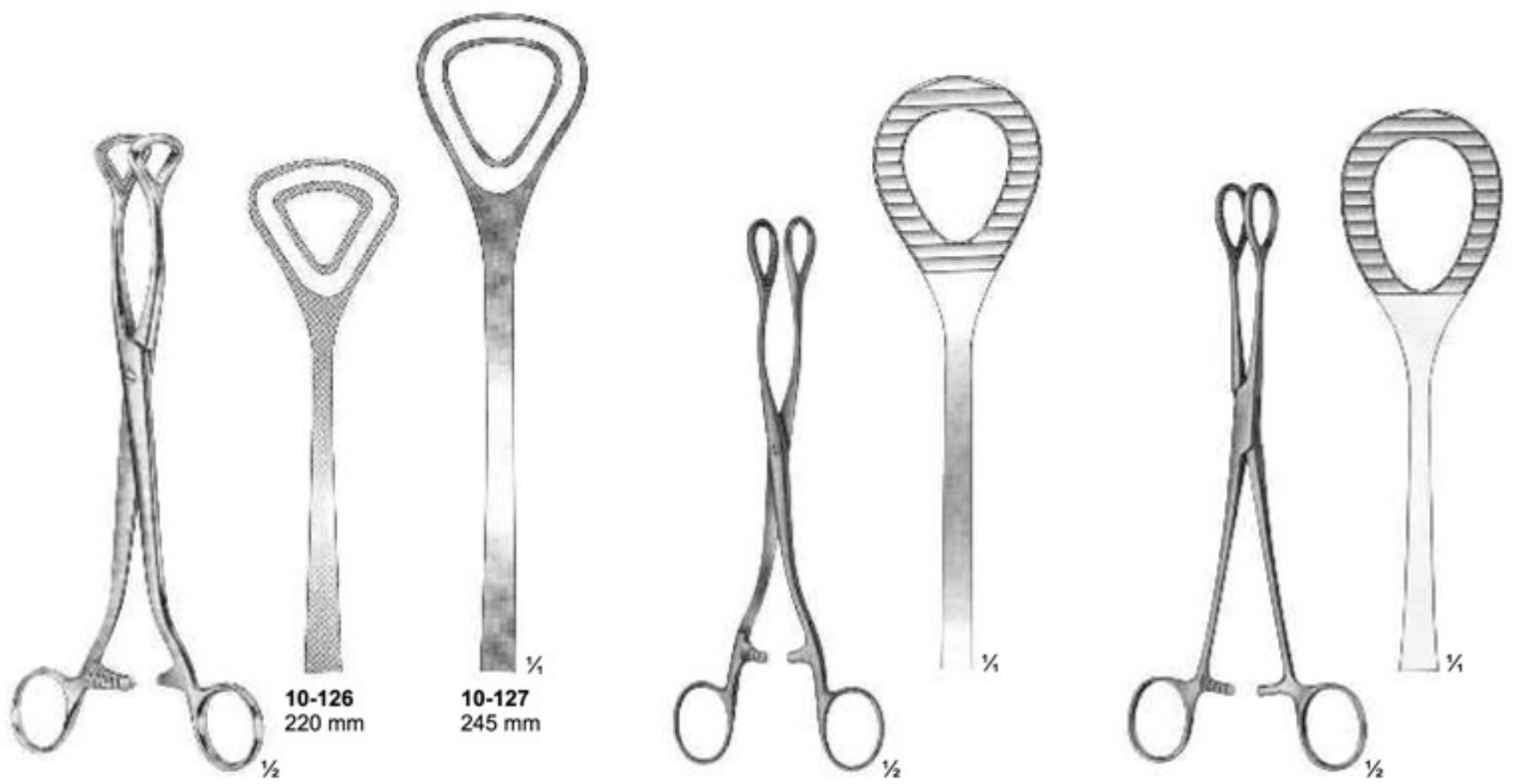

10-126 - 127
LUER

10-126
220 mm

10-127
245 mm

10-128
HEYWOOD-SMITH
200 mm

10-129
HEYWOOD-SMITH
modif
200 mm

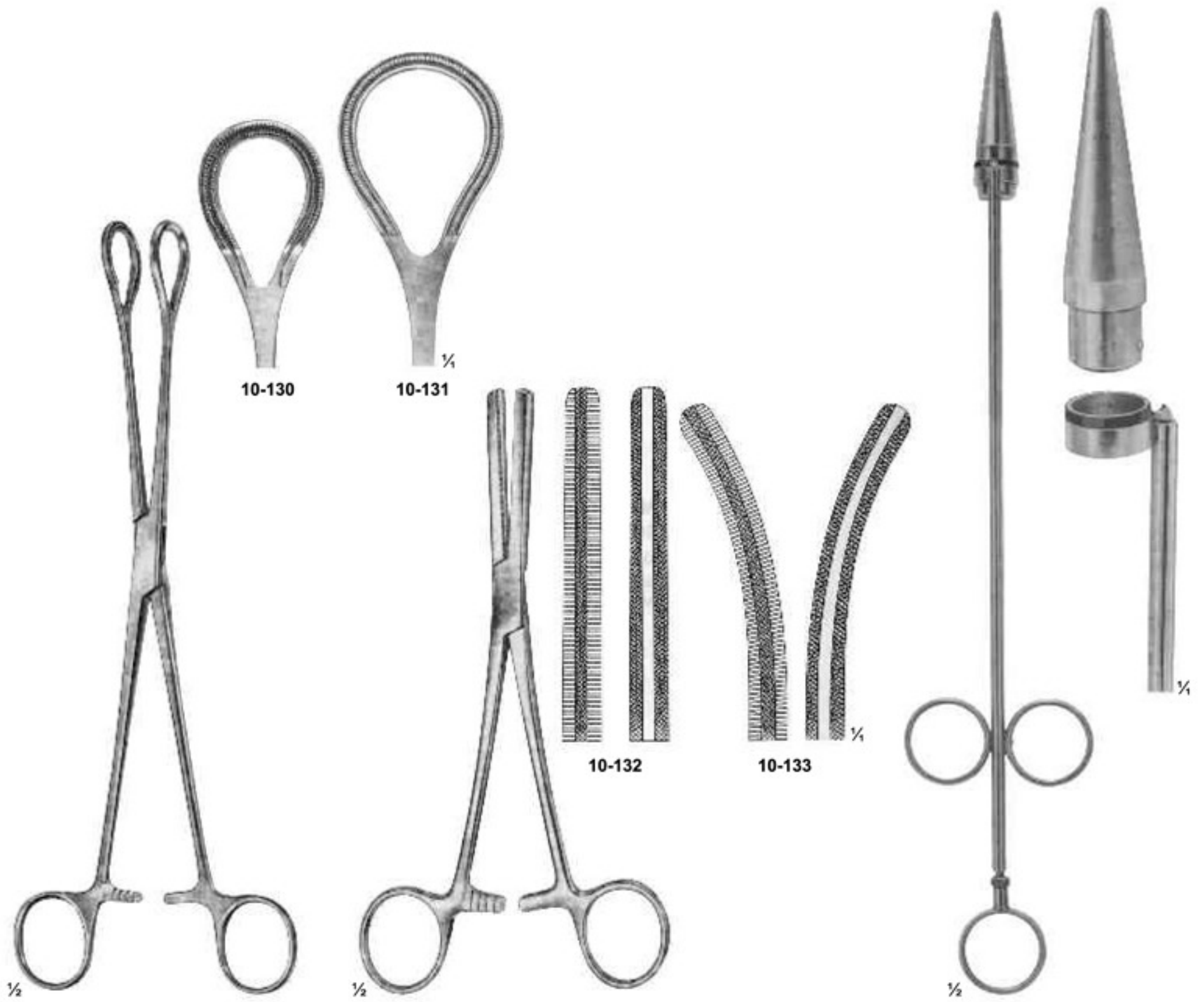

10-130 - 131
250 mm
10-131
270 mm

10-132 - 133
FERGUSSON
200 mm

10-134
RUDD
Haemorrhoidal ligator
with loading
attachment and 100
ligature rubber rings
315 mm



10-135
LOWER
180 mm



10-136
LAHEY (SWEET)
190 mm



10-137
LAHEY
220 mm



10-138
DESJARDINS
Gall duct-and cystic forceps
210 mm



10-139
NISSEN
Gall duct-and cystic forceps
215 mm

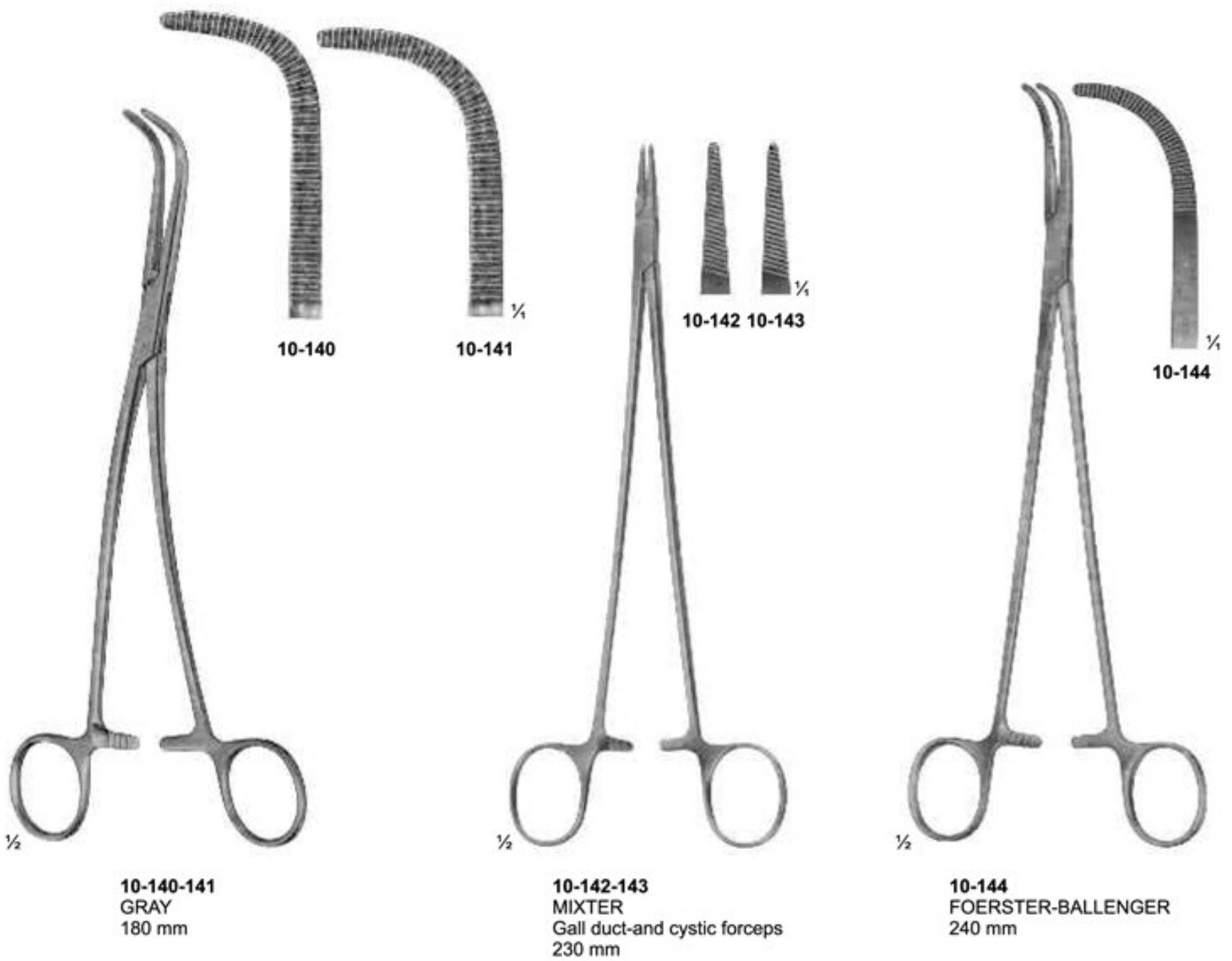

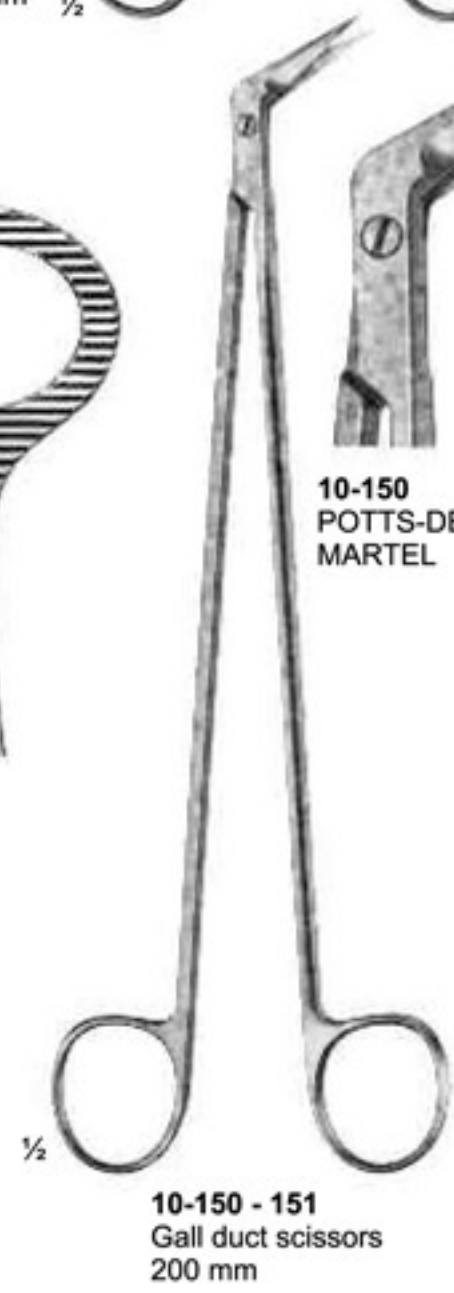
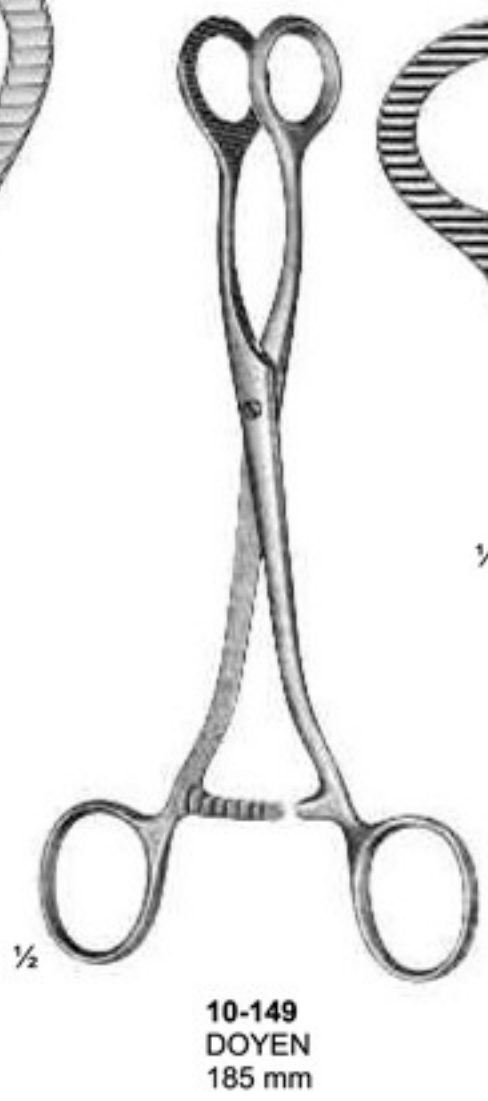
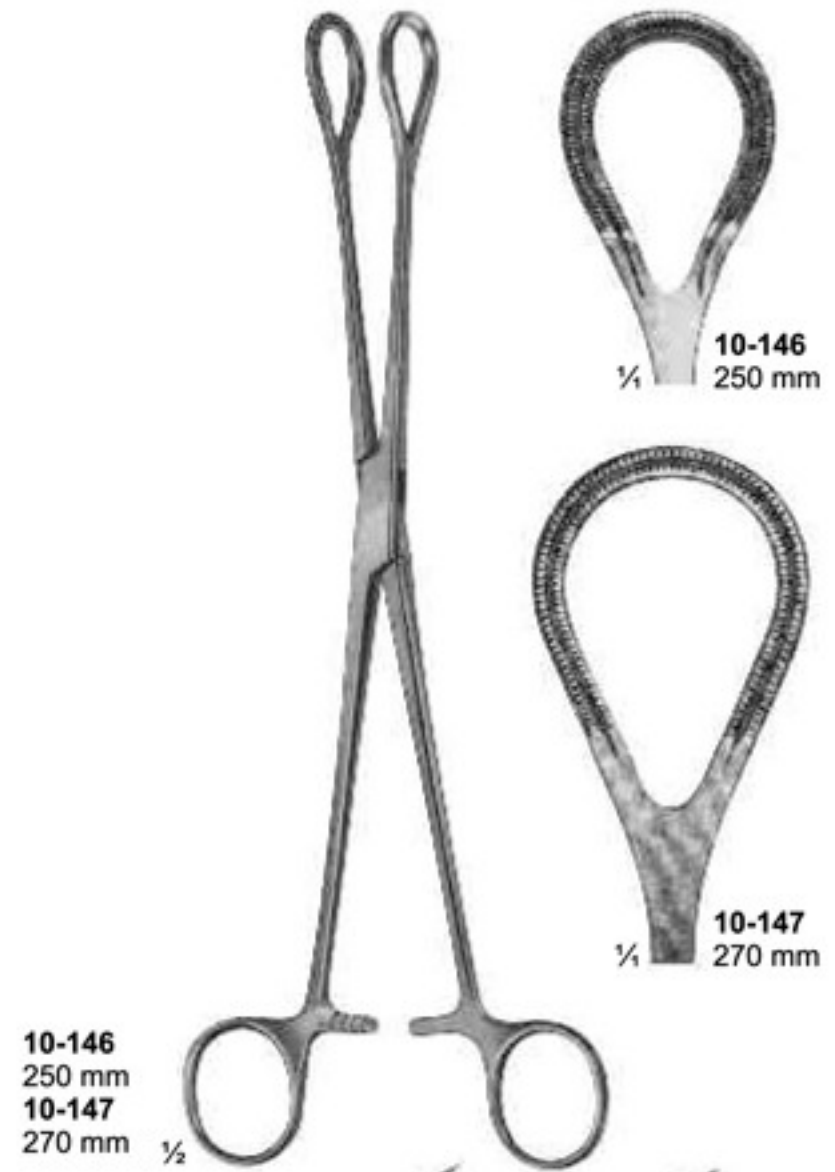
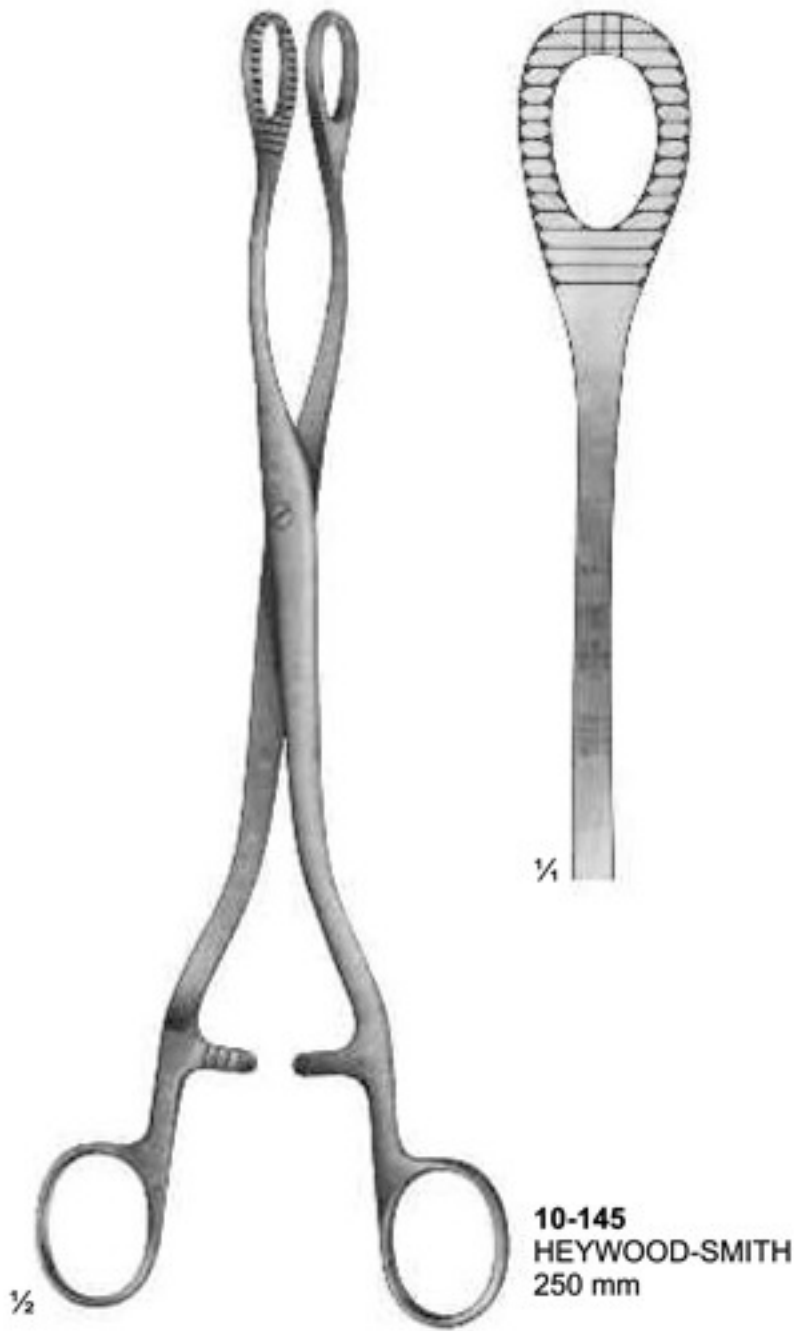

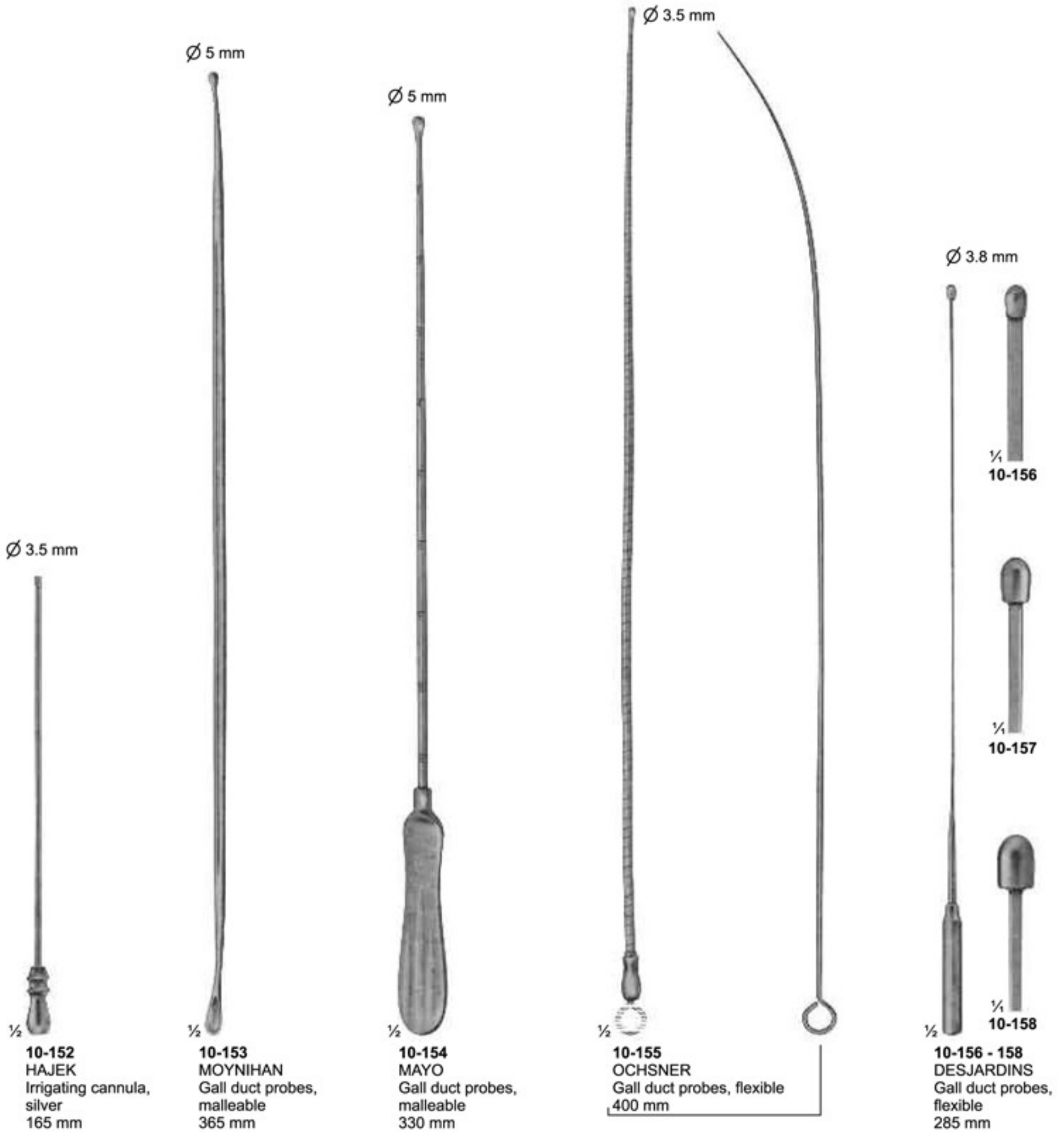

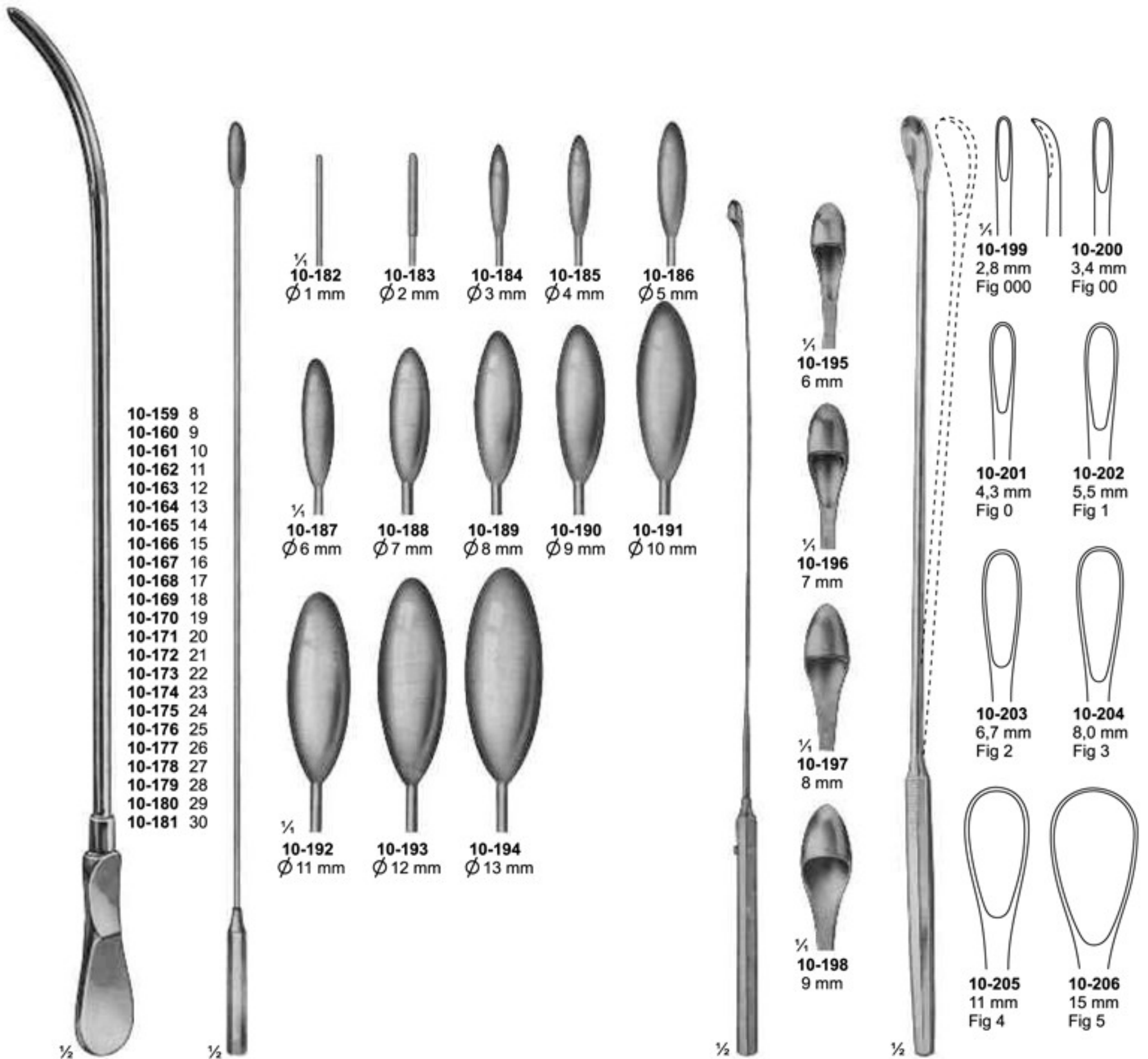

- 10-159 8
- 10-160 9
- 10-161 10
- 10-162 11
- 10-163 12
- 10-164 13
- 10-165 14
- 10-166 15
- 10-167 16
- 10-168 17
- 10-169 18
- 10-170 19
- 10-171 20
- 10-172 21
- 10-173 22
- 10-174 23
- 10-175 24
- 10-176 25
- 10-177 26
- 10-178 27
- 10-179 28
- 10-180 29
- 10-181 30

- 1/4 10-182 Ø 1 mm
- 10-183 Ø 2 mm
- 10-184 Ø 3 mm
- 10-185 Ø 4 mm
- 10-186 Ø 5 mm
- 10-187 Ø 6 mm
- 10-188 Ø 7 mm
- 10-189 Ø 8 mm
- 10-190 Ø 9 mm
- 10-191 Ø 10 mm
- 10-192 Ø 11 mm
- 10-193 Ø 12 mm
- 10-194 Ø 13 mm

- 1/4 10-195 6 mm
- 10-196 7 mm
- 10-197 8 mm
- 10-198 9 mm

- 1/4 10-199 2,8 mm Fig 000
- 10-200 3,4 mm Fig 00
- 10-201 4,3 mm Fig 0
- 10-202 5,5 mm Fig 1
- 10-203 6,7 mm Fig 2
- 10-204 8,0 mm Fig 3
- 10-205 11 mm Fig 4
- 10-206 15 mm Fig 5

10-159 - 181
DITTEL
Metall bougies and dilating sounds, stiff 345 mm

10-182 - 194
BAKES
Common bile duct dilators, malleable 315 mm, 320 mm

10-195 - 198
DESJARDINS
Probes and catch with flexible shaft 300 mm

10-199 - 206
LUER-KORTE modif with malleable shaft 310 mm

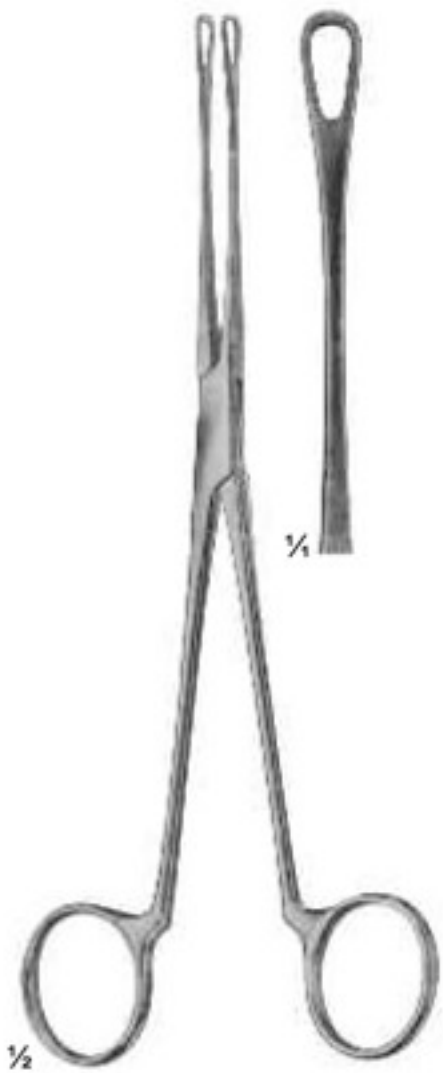

10-207
BLAKE
205 mm

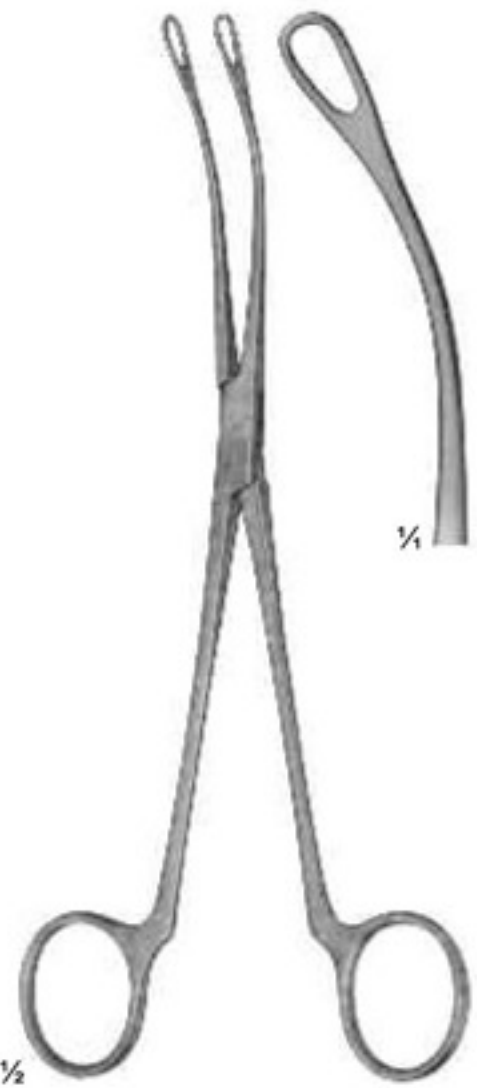

10-208
BLAKE
205 mm

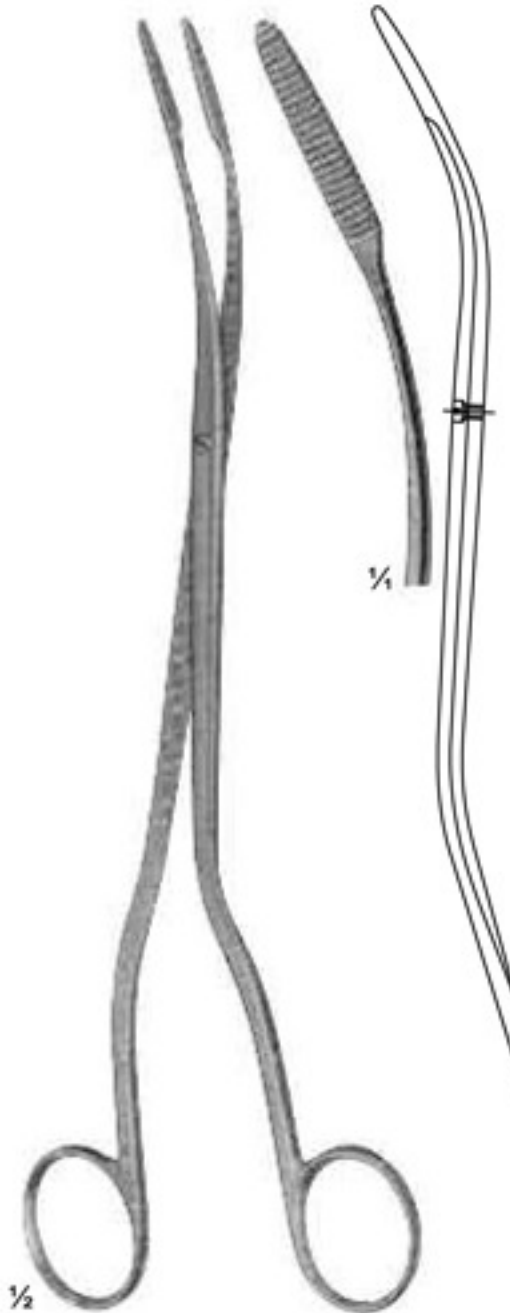

10-209
CZERNY
245 mm



10-210 - 213
DESJARDINS
225 mm

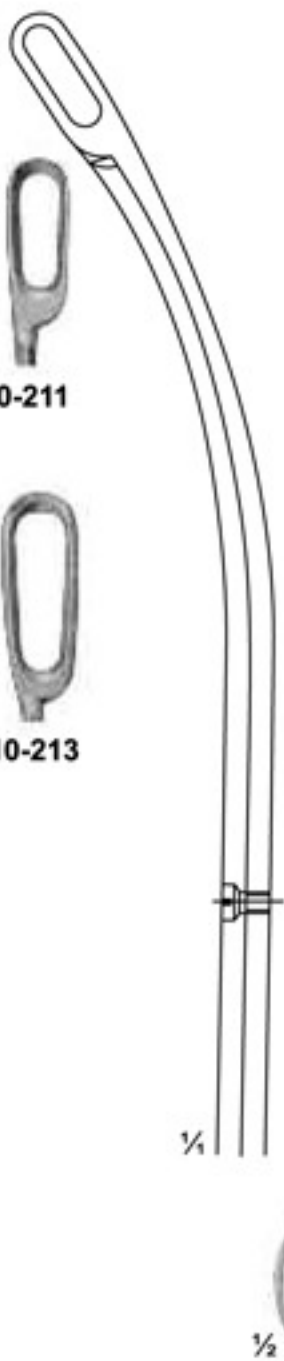

10-214 - 215
DESJARDINS
Extremely delicate patterns

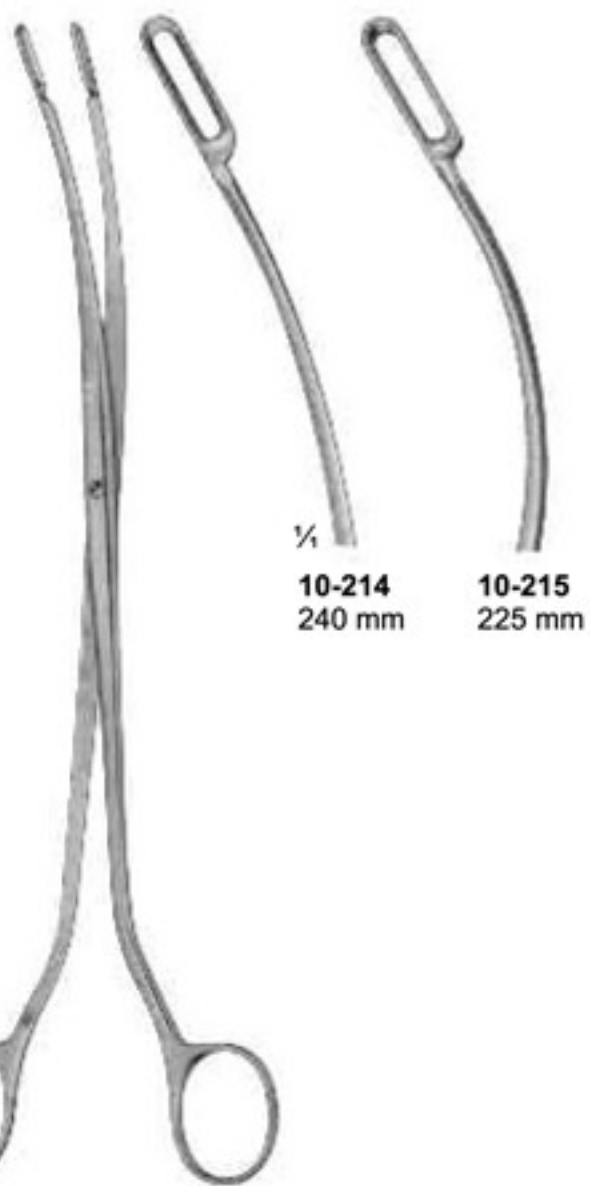

10-214
240 mm

10-215
225 mm

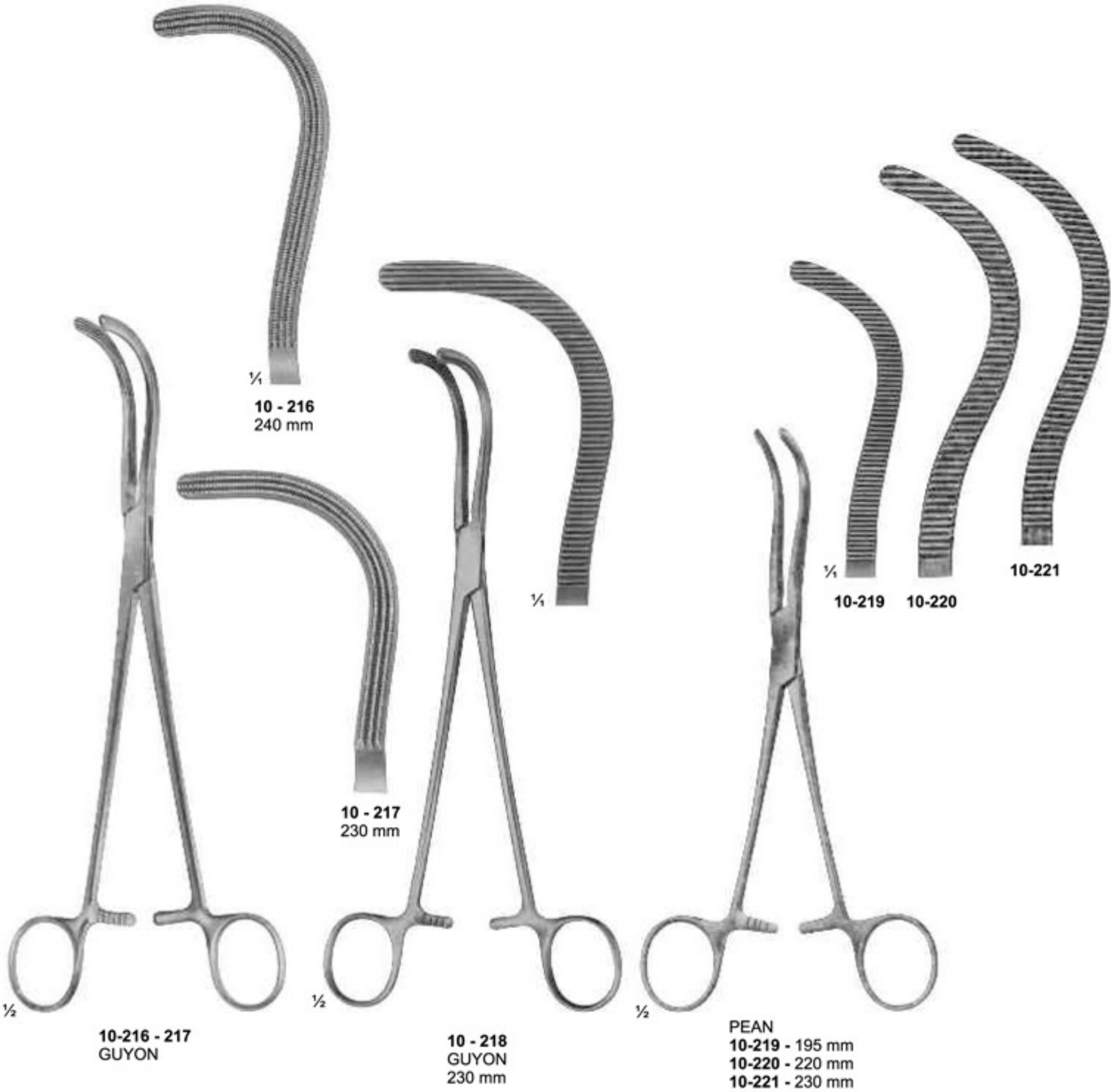

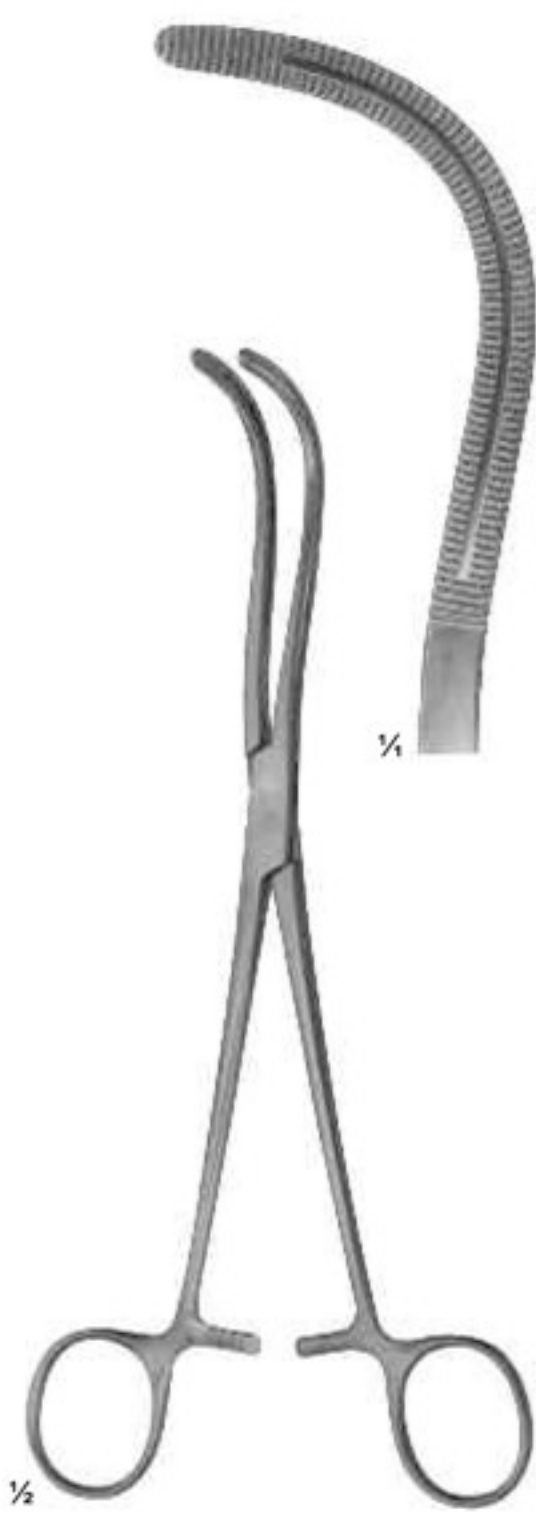

10-222
STILLE
220 mm

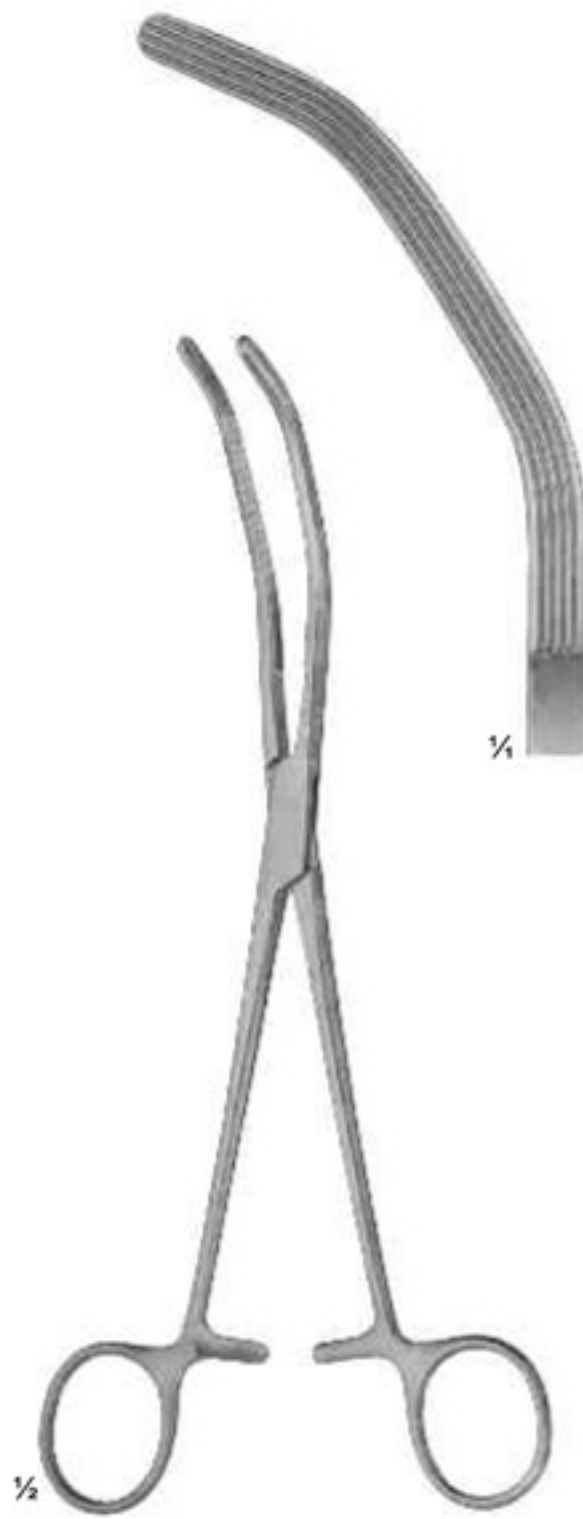

10-223
HERRICK
225 mm

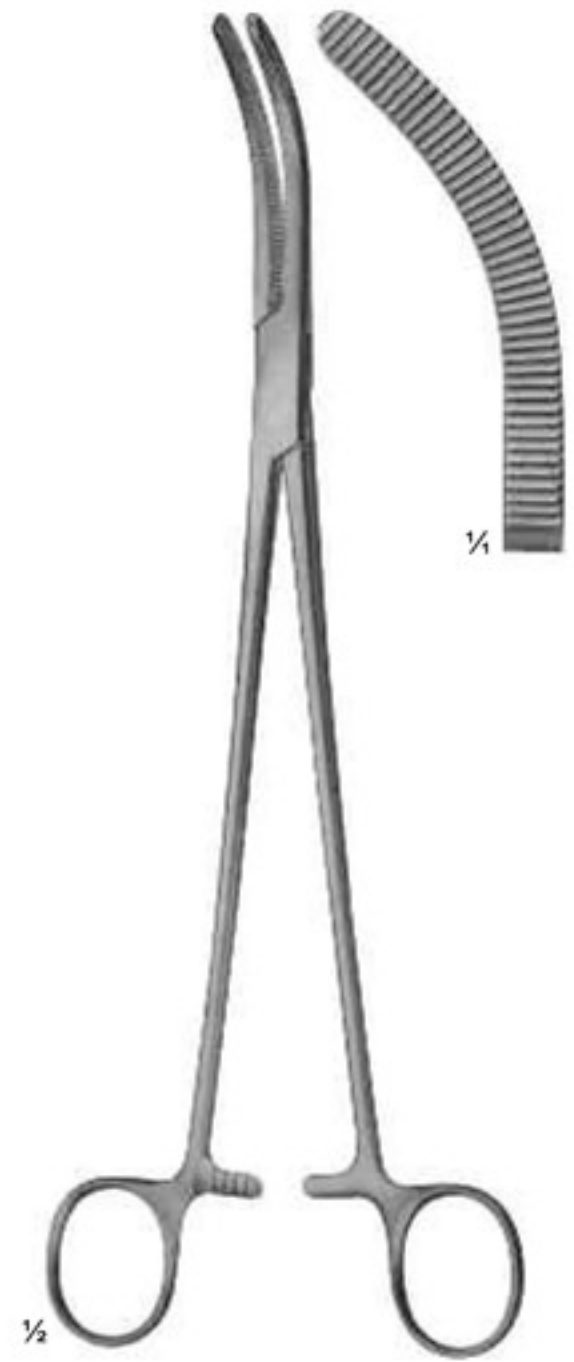

10-224
WERTHEIM
225 mm



10-225
COLLIN
285 mm

½



10-226
DARTIGUES
255 mm

½



10-227



10-228



10-229



$\frac{1}{4}$
10-230



10-231



10-232



$\frac{1}{4}$
10-233



$\frac{1}{2}$

10-227 - 230
RANDALL
225 mm

10-231 - 233
RANDALL
190 mm

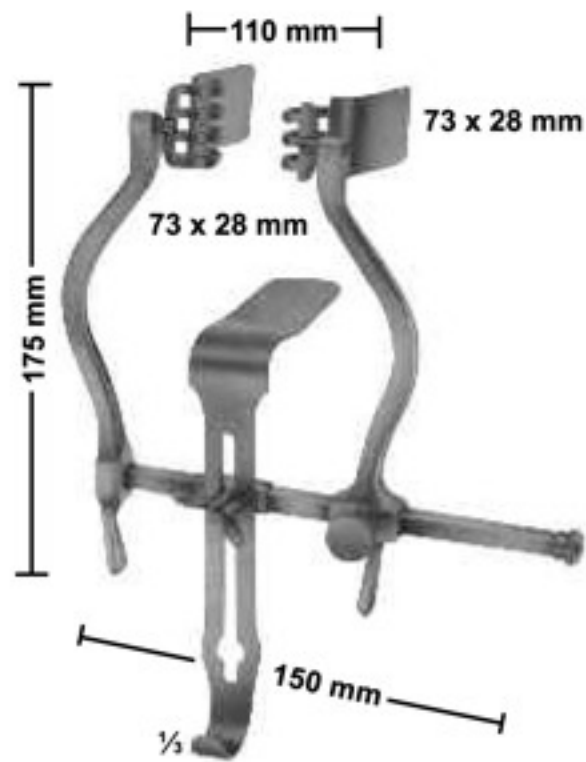

11-101
JUDD-MASSON
 Bladder-and suprapubic
 retractor



11-102
MILLIN
 Bladder retractor
 105X45 mm



11-103
LEGUEU
 Bladder retractor
 Center blade
 80 x 31 mm

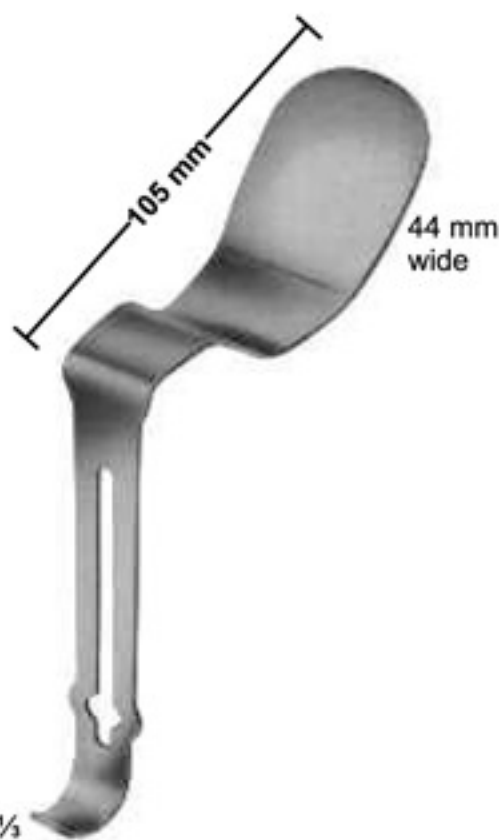

11-104
MILLIN
 Center bladder for
 retro pubic prostatectomy



11-105
KOCHER
 Bladder spatula
 235 mm



11-106
MATHIEU
Foreign body forceps
Length of shaft
190 mm

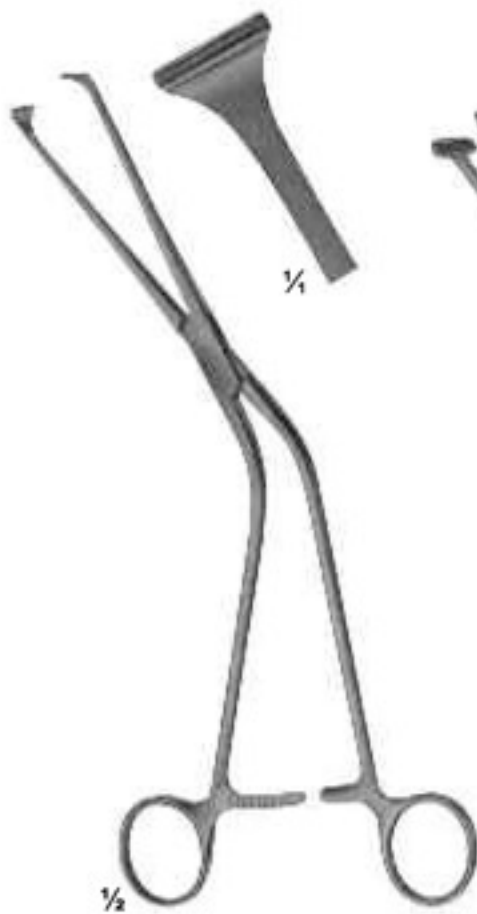

11-107
MILLIN
Lobe grasping
forceps
245 mm



11-108
MILLIN
Lobe grasping
forceps
235 mm



11-109
MILLIN
Bladder neck spreader
285 mm

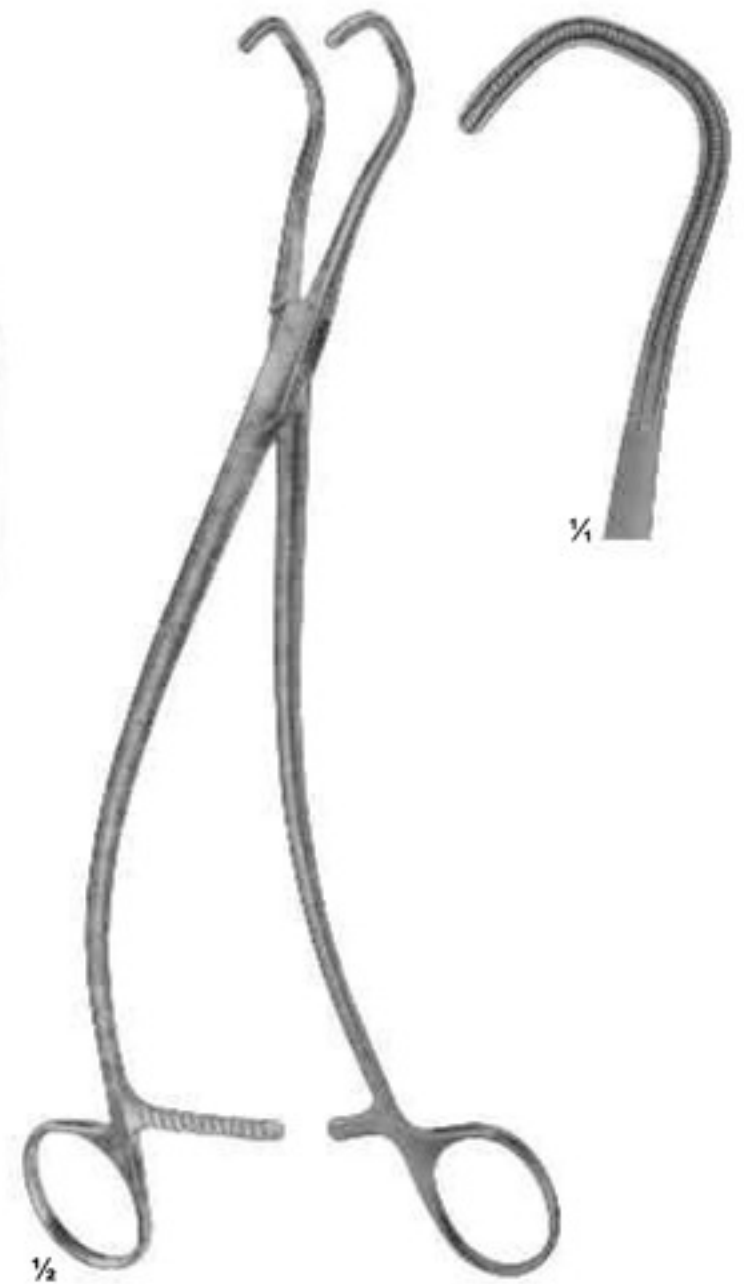

11-110
Ureter forceps
240 mm



11-111
GUYON
Catheter guide
(introducer)
365 mm

- 11-112 6
- 11-113 7
- 11-114 8
- 11-115 9
- 11-116 10
- 11-117 11
- 11-118 12
- 11-119 13
- 11-120 14
- 11-121 15
- 11-122 16
- 11-123 18
- 11-124 20

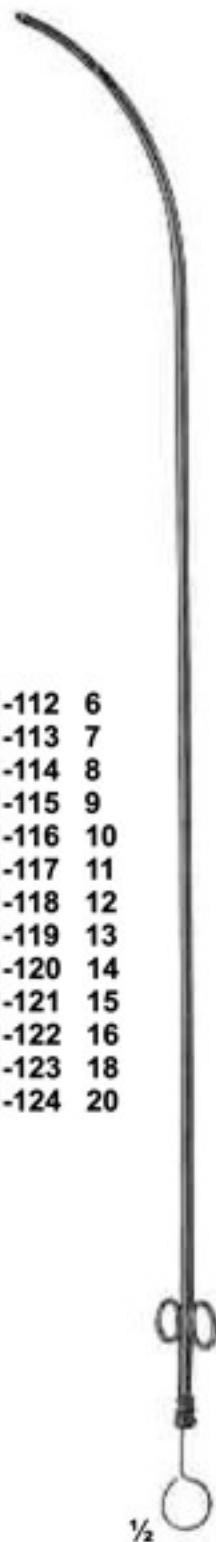

11-112 - 124
Female catheters,
metal
160 mm

- 11-125 8
- 11-126 9
- 11-127 10
- 11-128 11
- 11-129 12
- 11-130 13
- 11-131 14
- 11-132 15
- 11-133 16
- 11-134 17
- 11-135 18
- 11-136 19
- 11-137 20
- 11-138 21
- 11-139 22
- 11-140 23
- 11-141 24
- 11-142 25
- 11-143 26
- 11-144 27
- 11-145 28
- 11-146 29
- 11-147 30

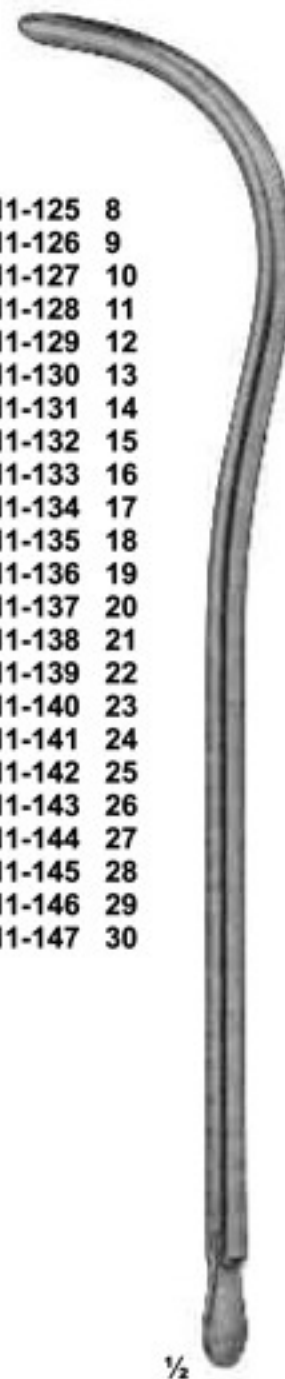

11-125 - 147
Urethral bougies
and dilating sounds
345 mm

- 11-148 Ben. 24/Charr. 12
- 11-149 Ben. 25
- 11-150 Ben. 26/Charr. 13
- 11-151 Ben. 27
- 11-152 Ben. 28/Charr. 14
- 11-153 Ben. 29
- 11-154 Ben. 30/Charr. 15
- 11-155 Ben. 31
- 11-156 Ben. 32/Charr. 16
- 11-157 Ben. 33
- 11-158 Ben. 34/Charr. 17
- 11-159 Ben. 35
- 11-160 Ben. 36/Charr. 18
- 11-161 Ben. 37
- 11-162 Ben. 38/Charr. 19
- 11-163 Ben. 39
- 11-164 Ben. 40/Charr. 20
- 11-165 Ben. 41
- 11-166 Ben. 42/Charr. 21
- 11-167 Ben. 43
- 11-168 Ben. 44/Charr. 22
- 11-169 Ben. 45
- 11-170 Ben. 46/Charr. 23
- 11-171 Ben. 47
- 11-172 Ben. 48/Charr. 24
- 11-173 Ben. 49
- 11-174 Ben. 50/Charr. 25
- 11-175 Ben. 51
- 11-176 Ben. 52/Charr. 26
- 11-177 Ben. 53
- 11-178 Ben. 54/Charr. 27
- 11-179 Ben. 55
- 11-180 Ben. 56/Charr. 28
- 11-181 Ben. 57
- 11-182 Ben. 58/Charr. 29
- 11-183 Ben. 59
- 11-184 Ben. 60/Charr. 30



11-148 - 184
Urethral bougies
and dilating sounds
255 mm



11-185
GUYON
Set of urethral bougies and dilating sounds,
in metal case, with lift out rack and bottom
rack, containing 21 urethral and dilating sounds.



11-186
WINKELMANN
Circumcision Clamps
12 mm / 16 mm / 20 mm



11-187
KLIMA ROSEGGER
35 X 1,8 mm
Sternal puncture needle

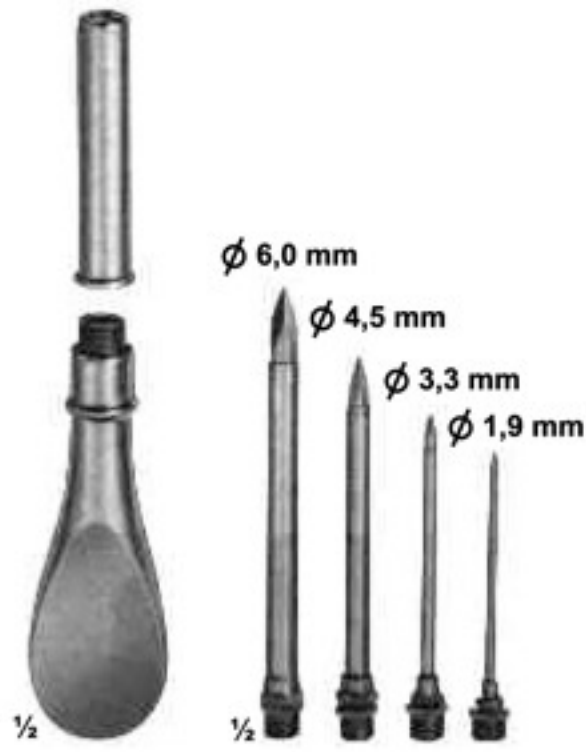

11-188
Universal trocar
with 4 tips



11-189 - 193
Inside dime. Outside dime
11-189 2,2 mm 3,0 mm
11-190 3,0 mm 4,0 mm
11-191 4,0 mm 5,0 mm
11-192 5,0 mm 6,0 mm
11-193 5,5 mm 6,5 mm
 for hydrocele and abdominal
 puncture



11-194 - 197
Inside dime. Outside dime
11-194 2,2 mm 3,0 mm
11-195 3,0 mm 4,0 mm
11-196 4,0 mm 5,0 mm
11-197 5,0 mm 6,0 mm
 for abdominal puncture,
 with stop-cock and lateral
 drain

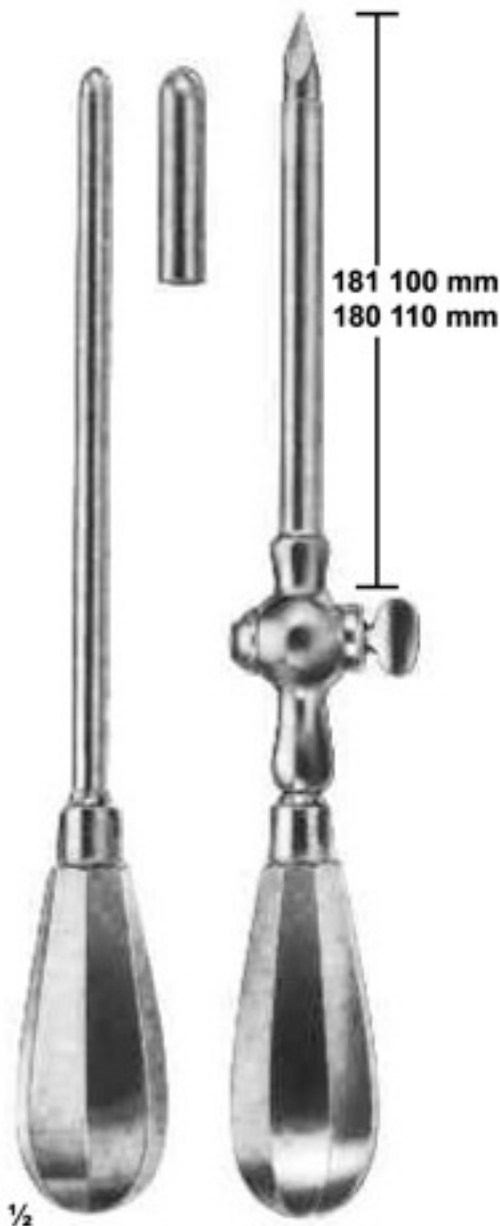

11-198 - 199
Inside dime. Outside dime
11-198 6,5 mm 8,0 mm
11-199 9,0 mm 10,0 mm
 Empyema trocar



11-200 - 203
Inside dime. Outside dime
11-200 3,0 mm 4,0 mm
11-201 3,6 mm 4,6 mm
11-202 4,3 mm 5,3 mm
11-203 5,0 mm 6,0 mm
 Gall bladder trocars



11-204
PIERCE
Antrum trocar
4,0 mm



11-205
COAKLEY
Antrum trocar
3,0 mm

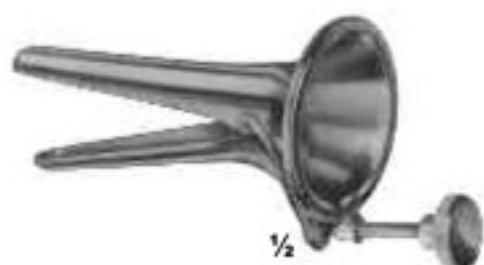

12-101
COLLIN
for children
53 x 10 mm

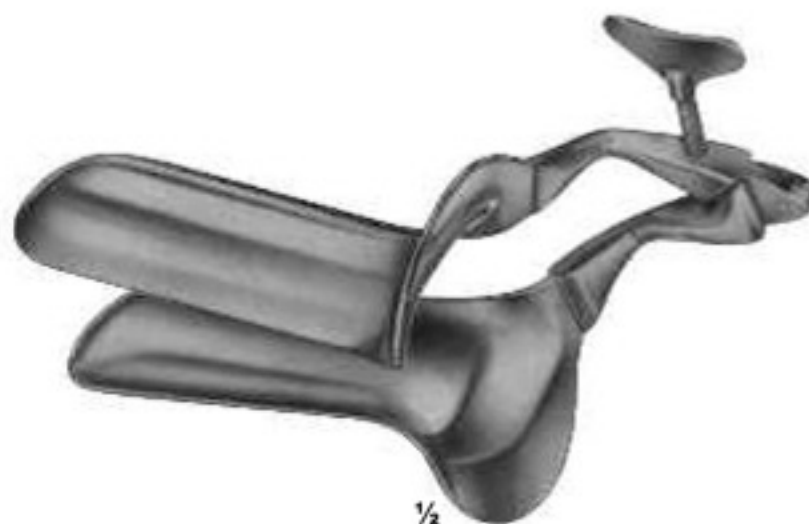

12-102 - 105
COLLIN

12-102	100/90mm	28 mm
12-103	100/90mm	32 mm
12-104	105/95mm	35 mm
12-105	115/105mm	40 mm

Total length/working length width



12-106
COLLIN
for virgins
95/85 x 18 mm



12-107
CUSCO
for virgins
75 x 17 mm



12-108
CUSCO
for virgins
75 x 17 mm



12-109 - 111
CUSCO

12-109	92X23-25 mm
12-110	100x25-27 mm
12-111	110x27-30 mm



½

12-112 - 115
CUSCO
STANDARD
12-112 80X24 mm
12-113 80X32 mm
12-114 90X36 mm
12-115 110X37 mm



½

12-116 - 119
CUSCO
12-116 80X24 mm
12-117 80X32 mm
12-118 90X36 mm
12-119 110X37 mm



½

12-120 - 122
CUSCO
12-120 80X24 mm
12-121 80X32 mm
12-122 115X36 mm



½

12-123 - 124
SEYFFERT
12-123 100X24 mm
12-124 110X32 mm
230 mm



½

12-125
SEMM
for children
and virgins
180 mm



12-126 - 128
GRAVE
12-126 75X20 mm
12-127 95X30 mm
12-128 105X33 mm

½



12-129 - 130
PEDERSON
12-129 100X22 mm
12-130 120X25 mm

½



12-131 - 132
BRIESKY
12-131 72X25 mm / 77X30 mm
12-132 75X30 mm / 92X38 mm
170 mm

½



12-133 - 134
BREISKY
12-133 100X22 mm
77 X30 mm
140 mm
12-134 120X25 mm
92 X38 mm
170 mm

½



12-135 - 137
SEIDL
12-135 80X8 mm
12-136 80X10 mm
12-137 90X14 mm
For children and infants
170 mm

½



12-138
KRISTELLER
70X15 mm, (170 mm)
For children

½



12-139 - 141
SIMS
12-139 70X26 mm
75 X30 mm 125 mm
12-140 75X30 mm
80 X85 mm 150 mm
11-141 80X36 mm
90 X40 mm 175 mm

½

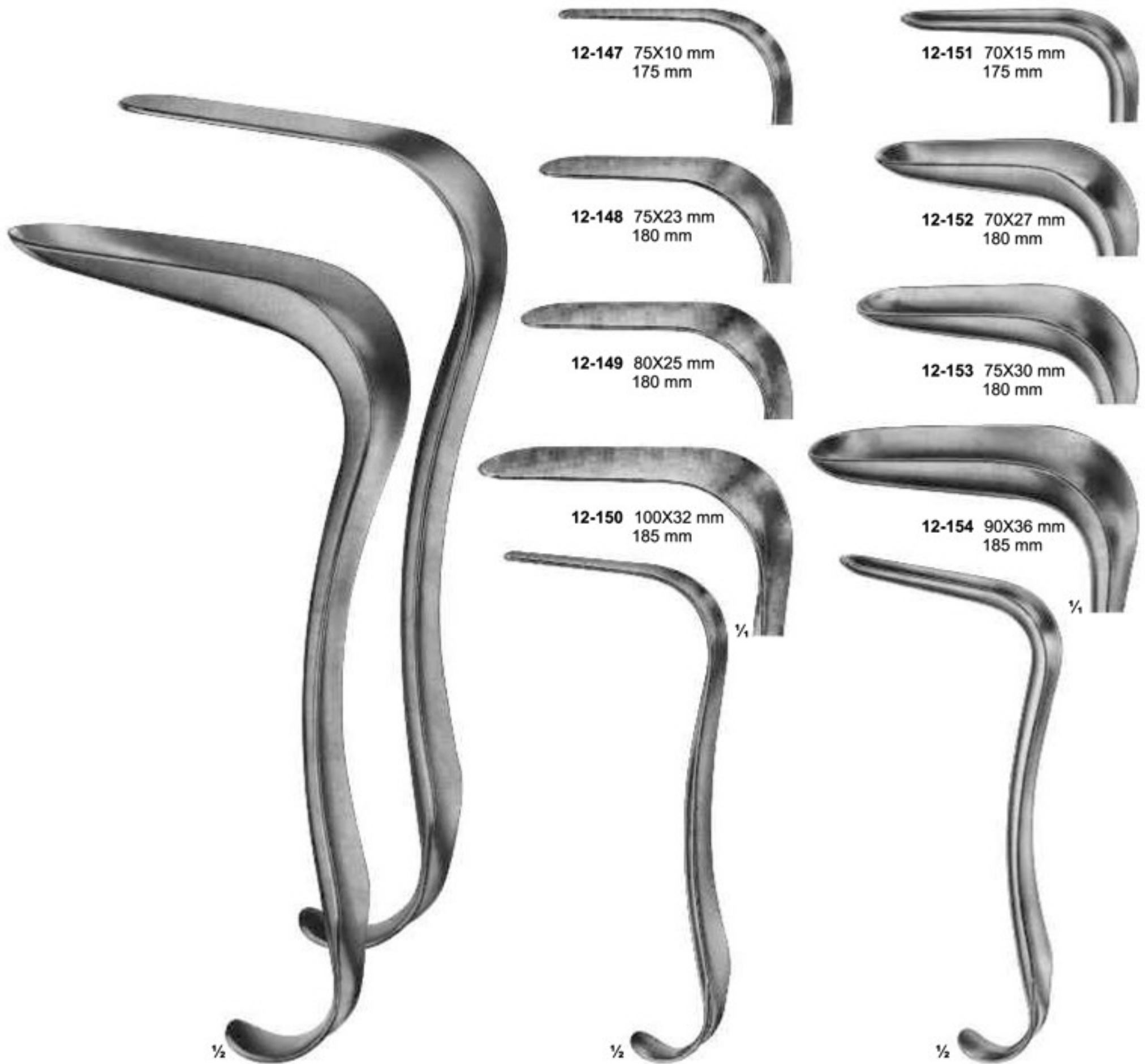

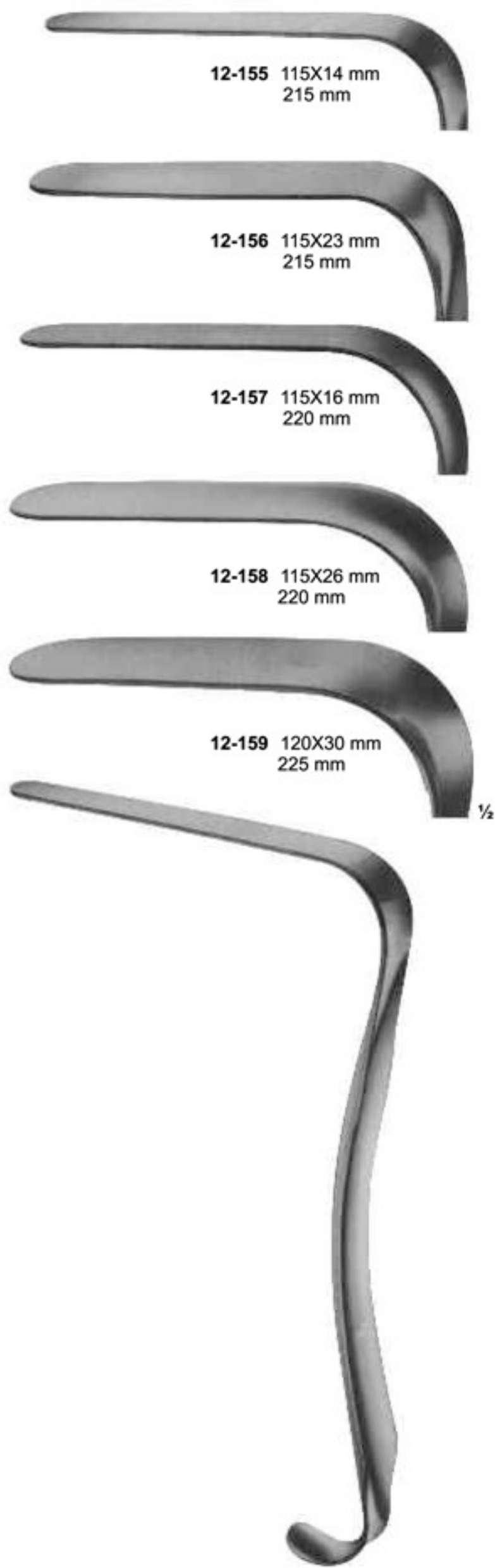

12-155 115X14 mm
215 mm

12-156 115X23 mm
215 mm

12-157 115X16 mm
220 mm

12-158 115X26 mm
220 mm

12-159 120X30 mm
225 mm

12-155 - 159
KRISTELLER
Upper blades

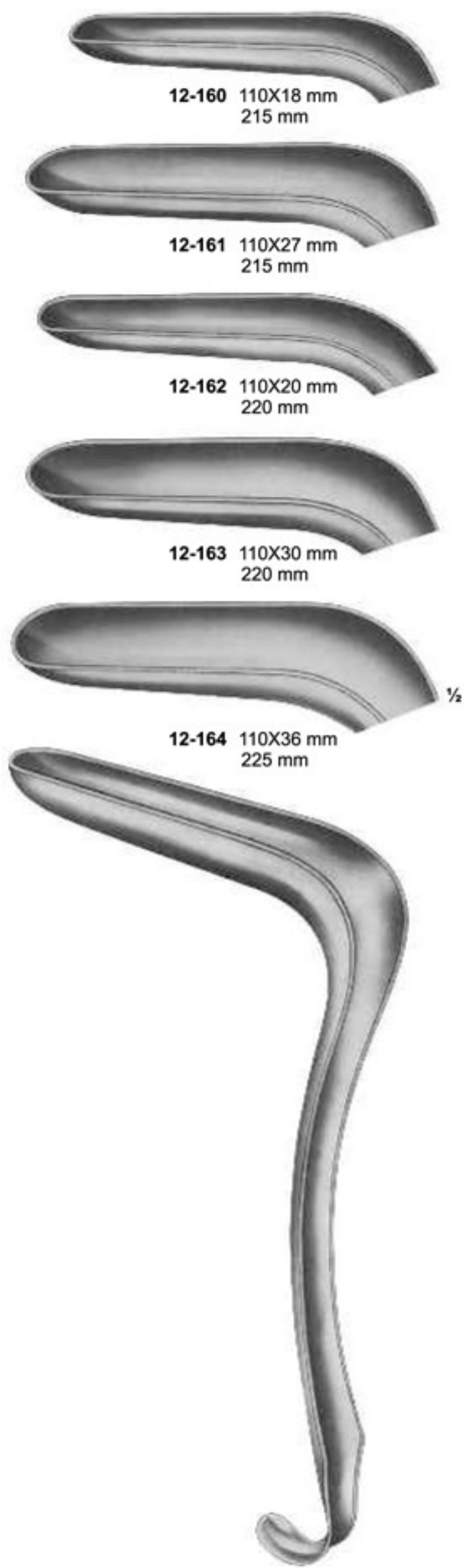

12-160 110X18 mm
215 mm

12-161 110X27 mm
215 mm

12-162 110X20 mm
220 mm

12-163 110X30 mm
220 mm

12-164 110X36 mm
225 mm

12-160 - 164
KRISTELLER
Lower blades

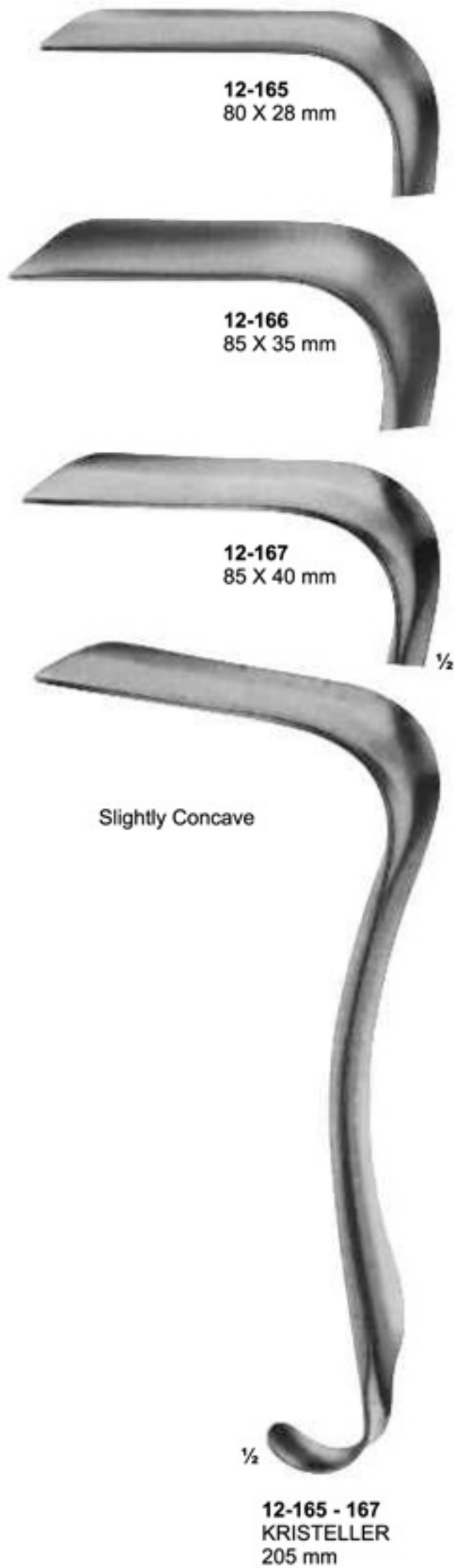



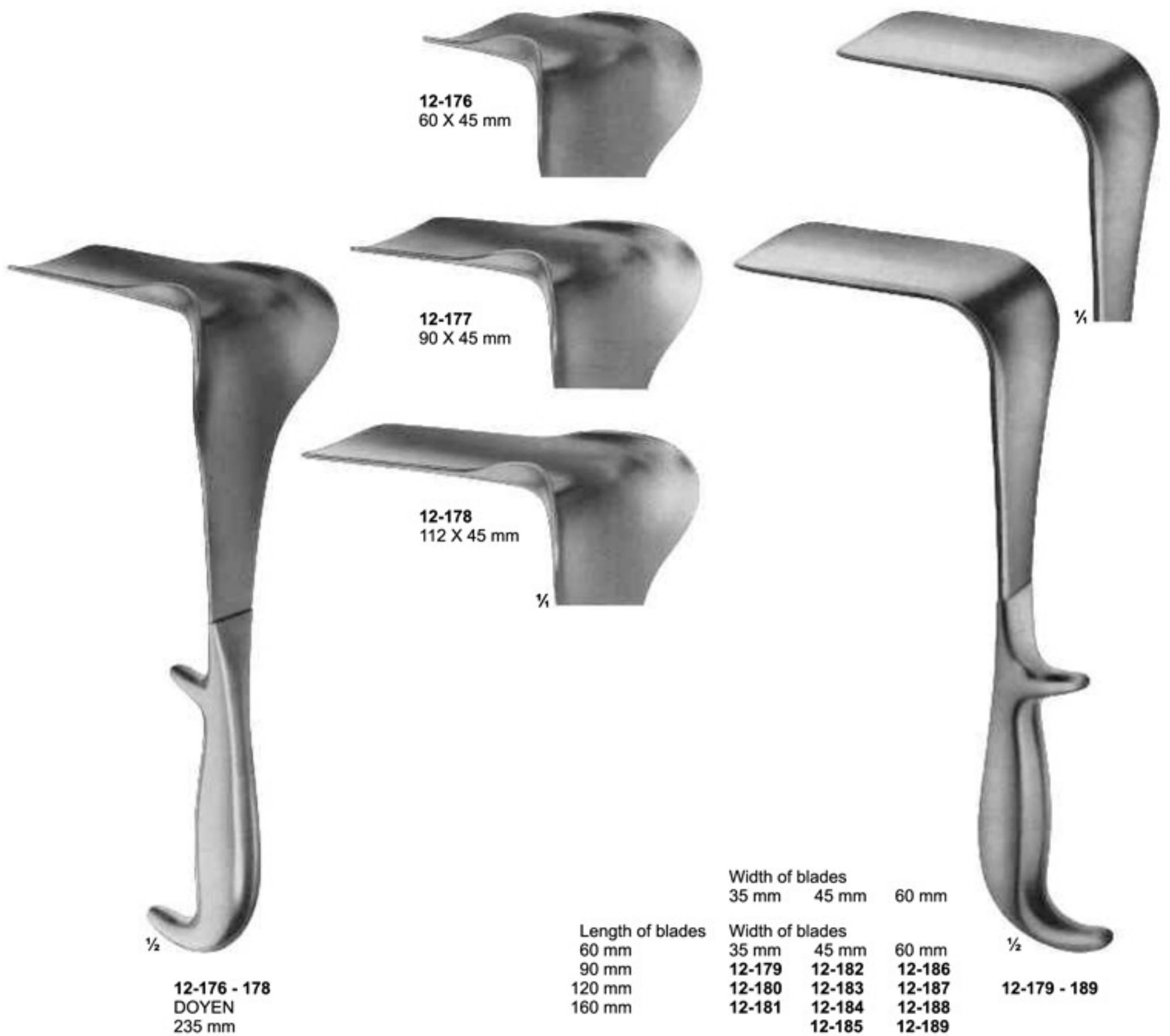



½
12-190 - 194
 BREISKY
 WIENER MODELL/
 VIENNA PATTERN
 12-190 100 X 20 mm
 12-191 100 X 25 mm
 12-192 100 X 30 mm
 12-193 100 X 35 mm
 12-194 100 X 40 mm
 300 mm

½
12-195 - 199
 BREISKY
 WIENER MODELL/
 VIENNA PATTERN
 12-195 130 X 20 mm
 12-196 130 X 25 mm
 12-197 130 X 30 mm
 12-198 130 X 35 mm
 12-199 130 X 40 mm
 320 mm

½
12-200 - 201
 WEISSBARTH
 12-200 80 X 28 mm
 12-201 85 X 42 mm
 210 mm

½
12-202
 DOYEN
 lateral speculum
 80 x 30 mm
 250 mm



12-203
SIMON
115 X 22 mm
275 mm

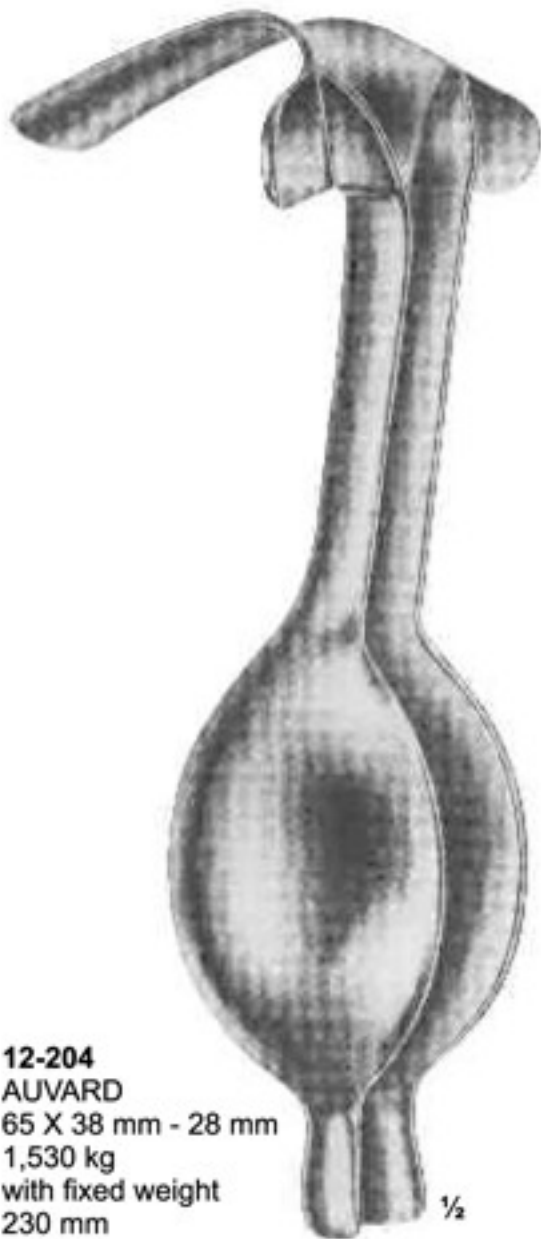

12-204
AUVARD
65 X 38 mm - 28 mm
1,530 kg
with fixed weight
230 mm



12-205 - 206
AUVARD
12-205 75 X 42 mm
(40 mm)
12-206 105 X 43 mm
(40 mm)
with detachable wight
230 mm



12-207
MARTIN
with hook shaped
handle for hanging
in weights
270 mm

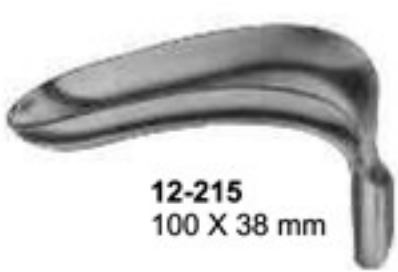
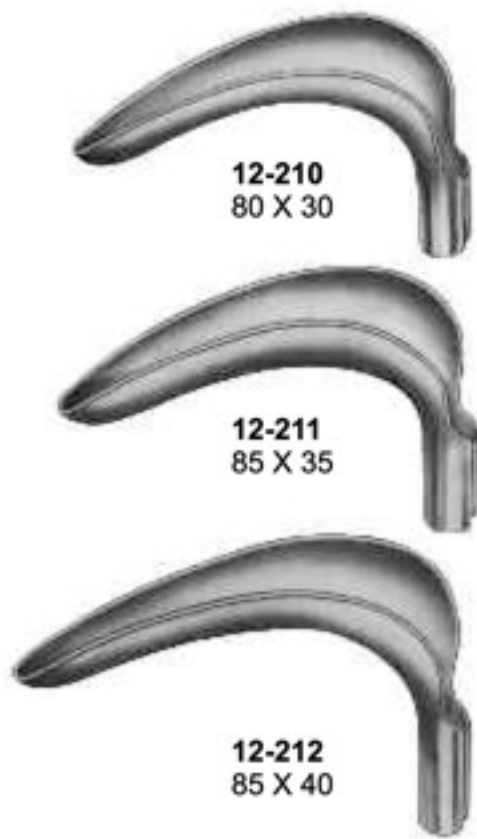



½
12-221
JOLL (FRIEDMAN)
 155 mm



½
12-222
RICHTER
 170 mm



½
12-223
GELPI
 135 mm



½
12-224
GELPI
 175 mm



13-101	1	mm	13-123	23	mm
13-102	2	mm	13-124	24	mm
13-103	3	mm	13-125	25	mm
13-104	4	mm	13-126	26	mm
13-105	5	mm	13-127	1	1/2mm
13-106	6	mm	13-128	2	1/2mm
13-107	7	mm	13-129	3	1/2mm
13-108	8	mm	13-130	4	1/2mm
13-109	9	mm	13-131	5	1/2mm
13-110	10	mm	13-132	6	1/2mm
13-111	11	mm	13-133	7	1/2mm
13-112	12	mm	13-134	8	1/2mm
13-113	13	mm	13-135	9	1/2mm
13-114	14	mm	13-136	10	1/2mm
13-115	15	mm	13-137	11	1/2mm
13-116	16	mm	13-138	12	1/2mm
13-117	17	mm	13-139	13	1/2mm
13-118	18	mm	13-140	14	1/2mm
13-119	19	mm	13-141	15	1/2mm
13-120	20	mm	13-142	16	1/2mm
13-121	21	mm	13-143	17	1/2mm
13-122	22	mm			

13-101 - 143
HEGAR
with very conical point
185 mm



13-144	1+2	mm
13-145	3+4	mm
13-146	5+6	mm
13-147	7+8	mm
13-148	9+10	mm
13-149	11+12	mm
13-150	13+14	mm
13-151	15+16	mm
13-152	17+18	mm

13-144 - 152
HEGAR
205 mm

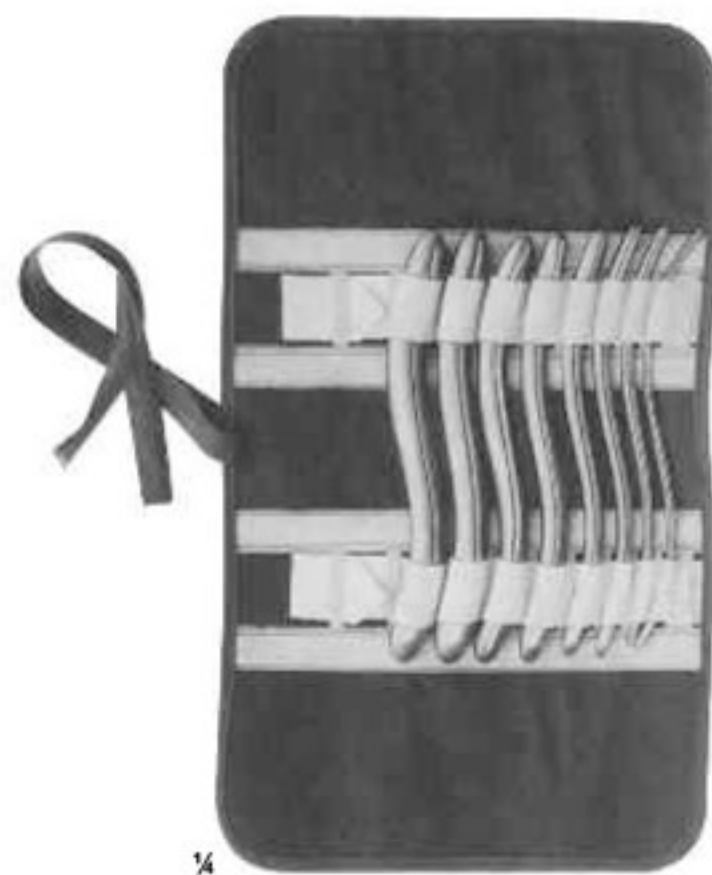

13-153
HEGAR
Uterine dilator set, in canvas
roll with 8 dilators.



13-154
HEGAR
Dilator set consisting of:
14 Dilators,
1 Rack for dilators (4 - 12 mm)
1 Rack for Dilators (13 - 17 mm)
1 Metal case only,
with hinged lid, stainless 200 X 100 X 35 mm

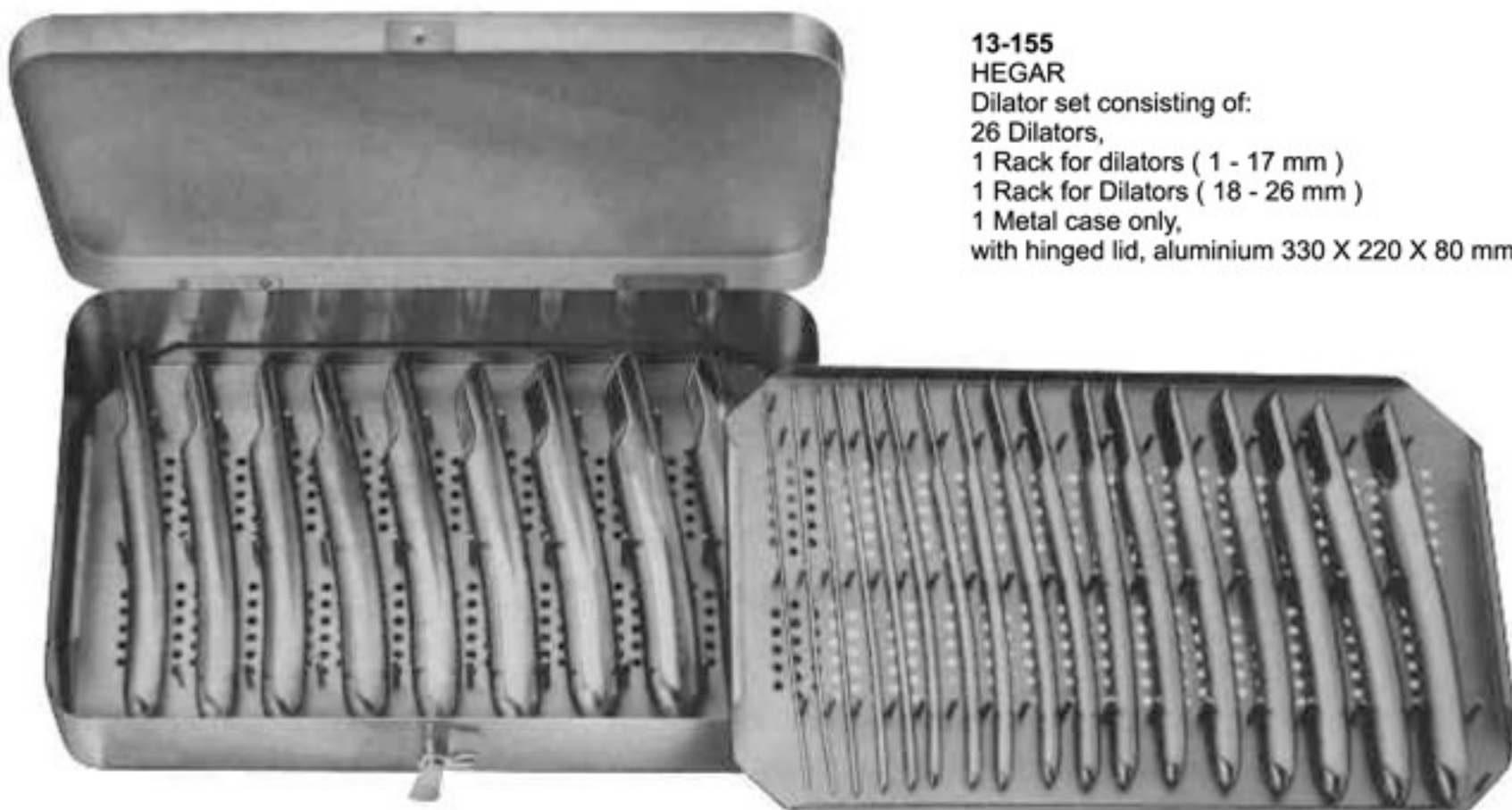

13-155
HEGAR
Dilator set consisting of:
26 Dilators,
1 Rack for dilators (1 - 17 mm)
1 Rack for Dilators (18 - 26 mm)
1 Metal case only,
with hinged lid, aluminium 330 X 220 X 80 mm

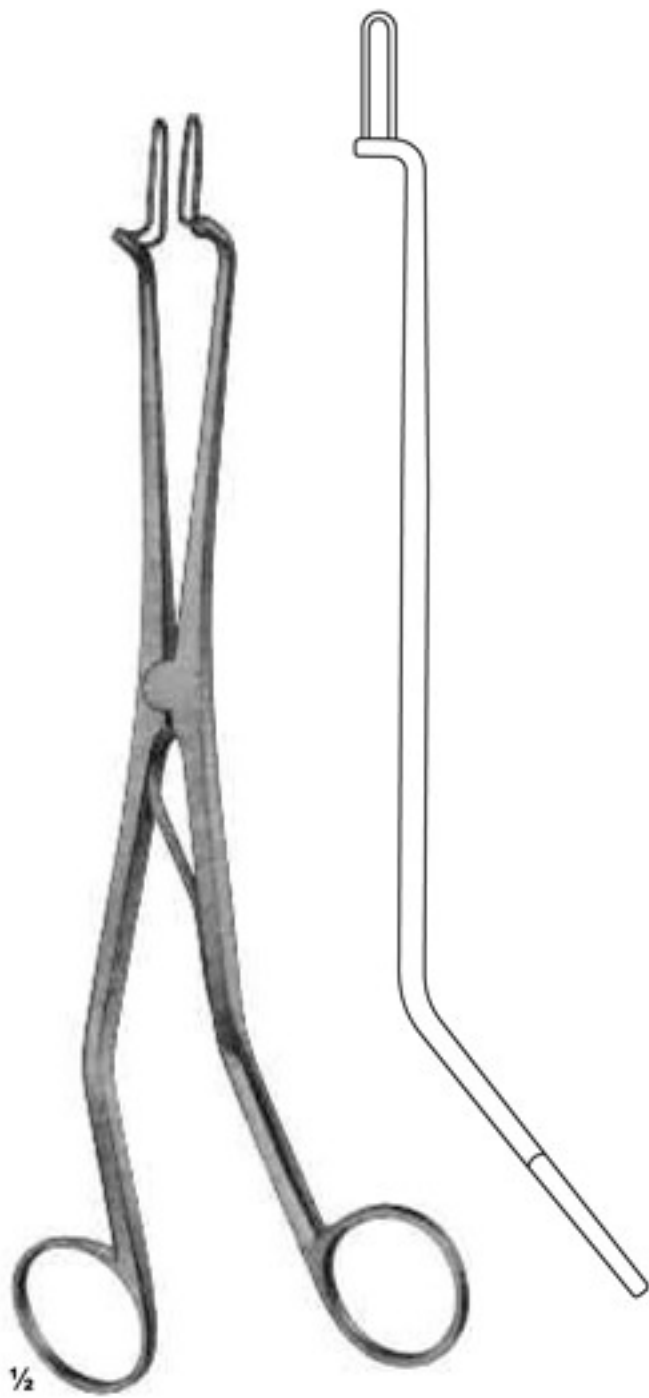

13-156
KOGAN
Endospecula for cervix
and urethra, without ratchet
240 mm



13-157
KOGAN
Endospecula for cervix
and urethra, with
scale-ratchet and fixing screws
240 mm

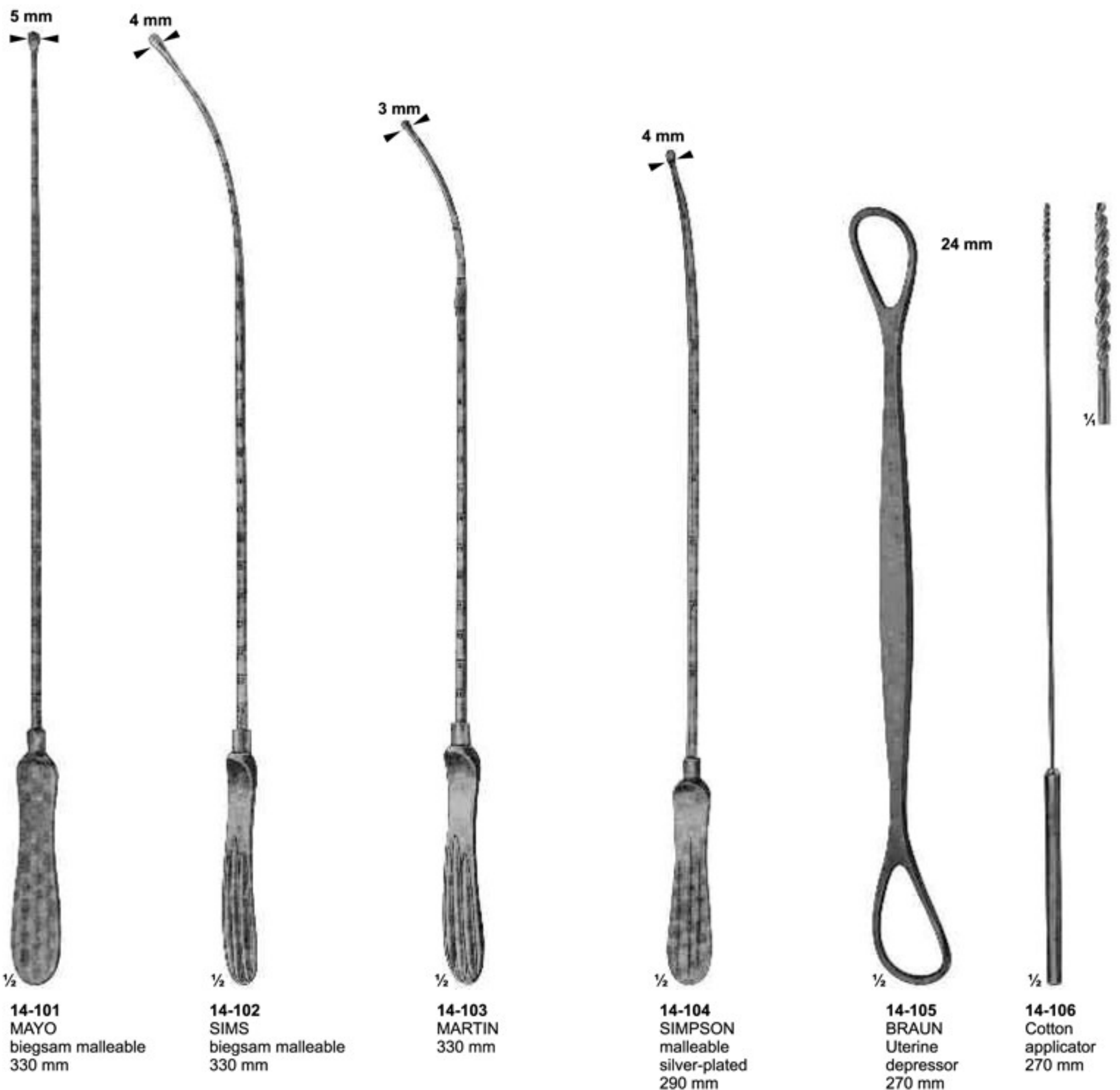

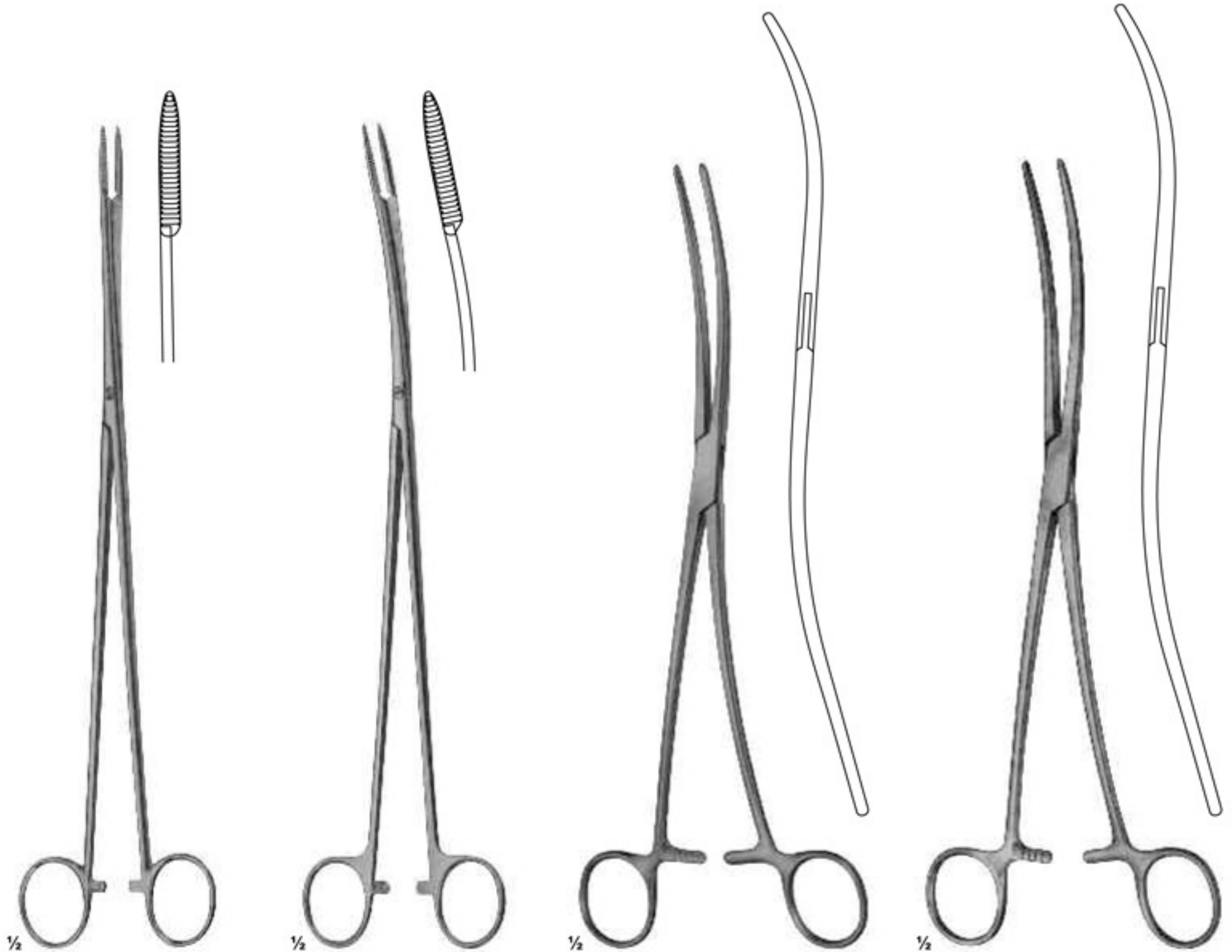

14-107
PELKMANN
260 mm

14-108
PELKMANN
260 mm

14-109
BOZEMANN
250 mm

14-110
BOZEMANN
255 mm

Jaws with longitudinal groove

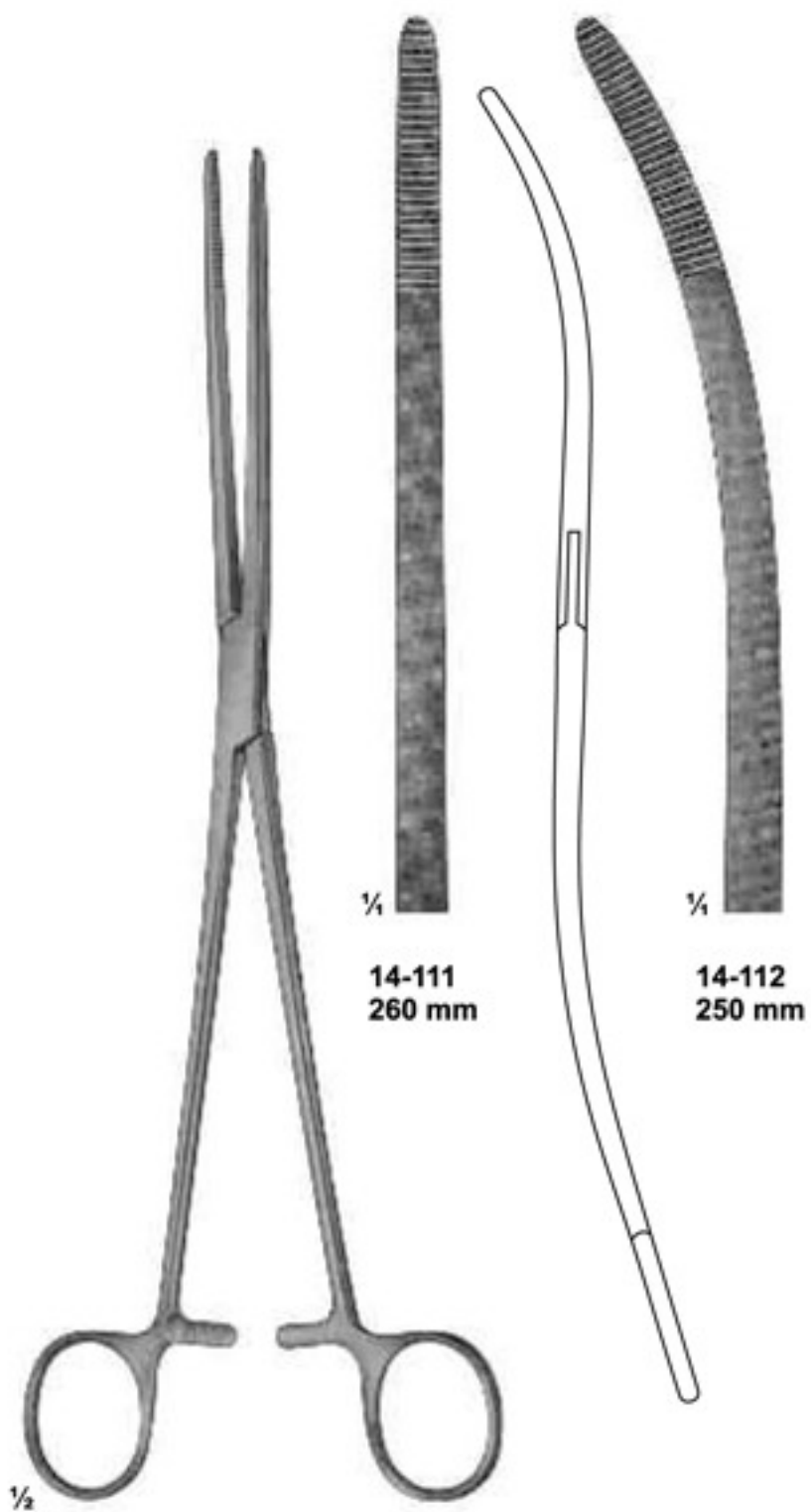

14-111 - 112
BOZEMANN



14-113
BOZEMANN-DOUGLAS
260 mm

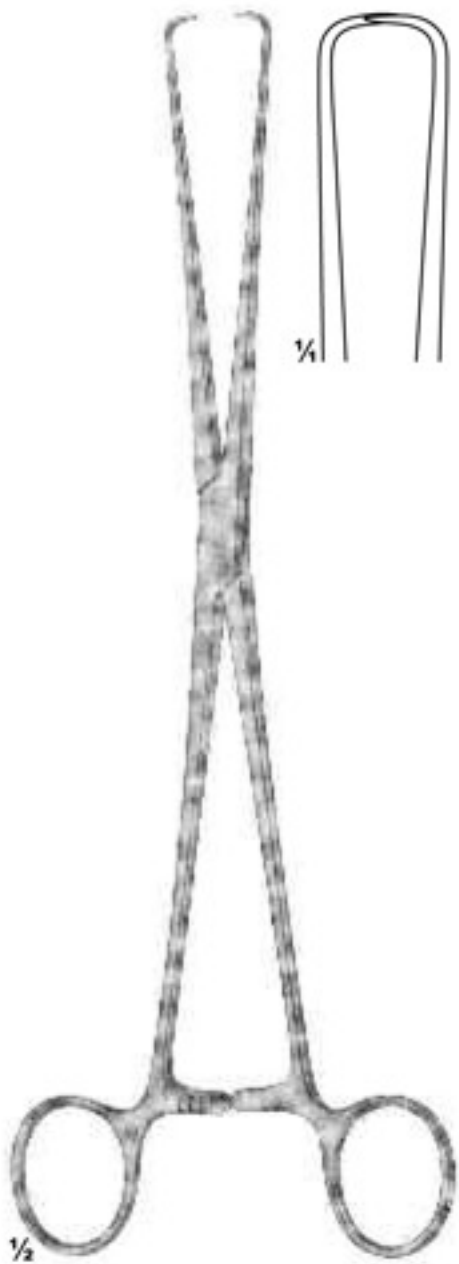

14-114
BRAUN
slender type
250 mm



14-115
SCHRODER
250 mm

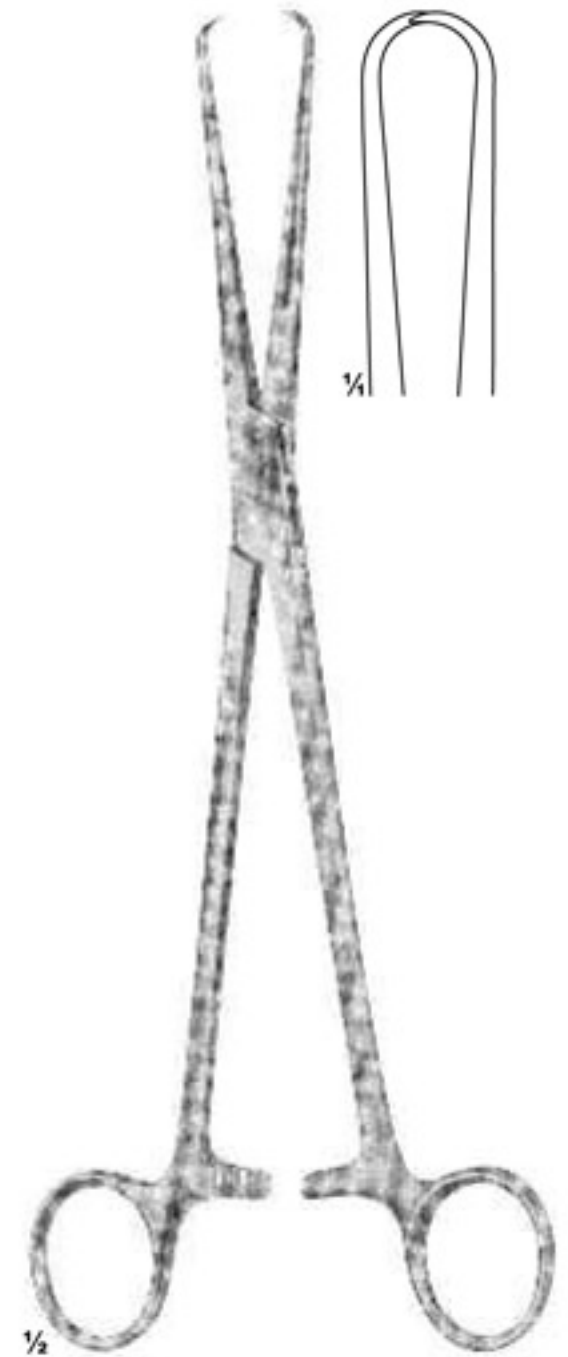

14-116
POZZI
heavy type
255 mm



14-117
265 mm

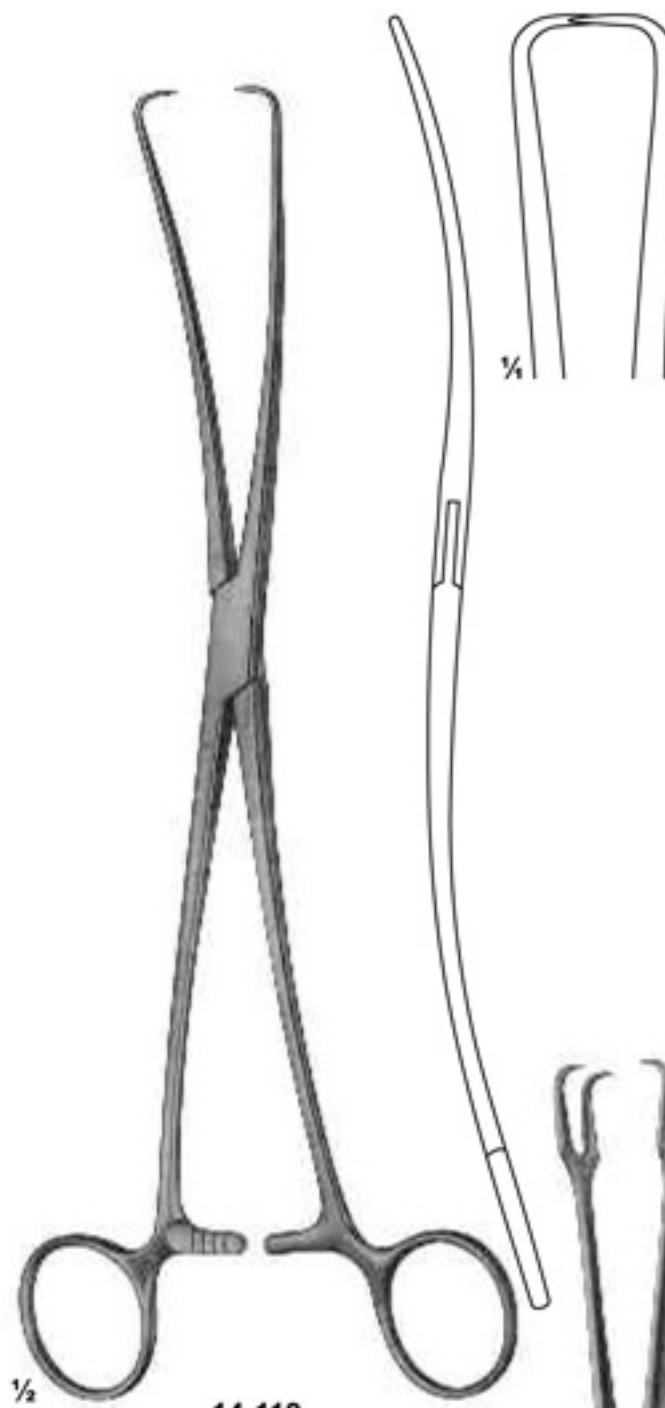

14-118
DUPLAY
250 mm

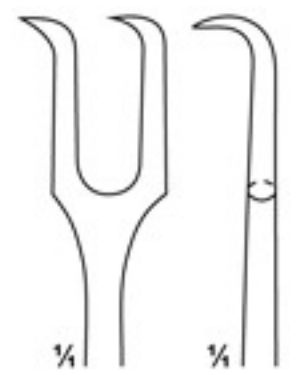

14-119
LAHEY
155 mm

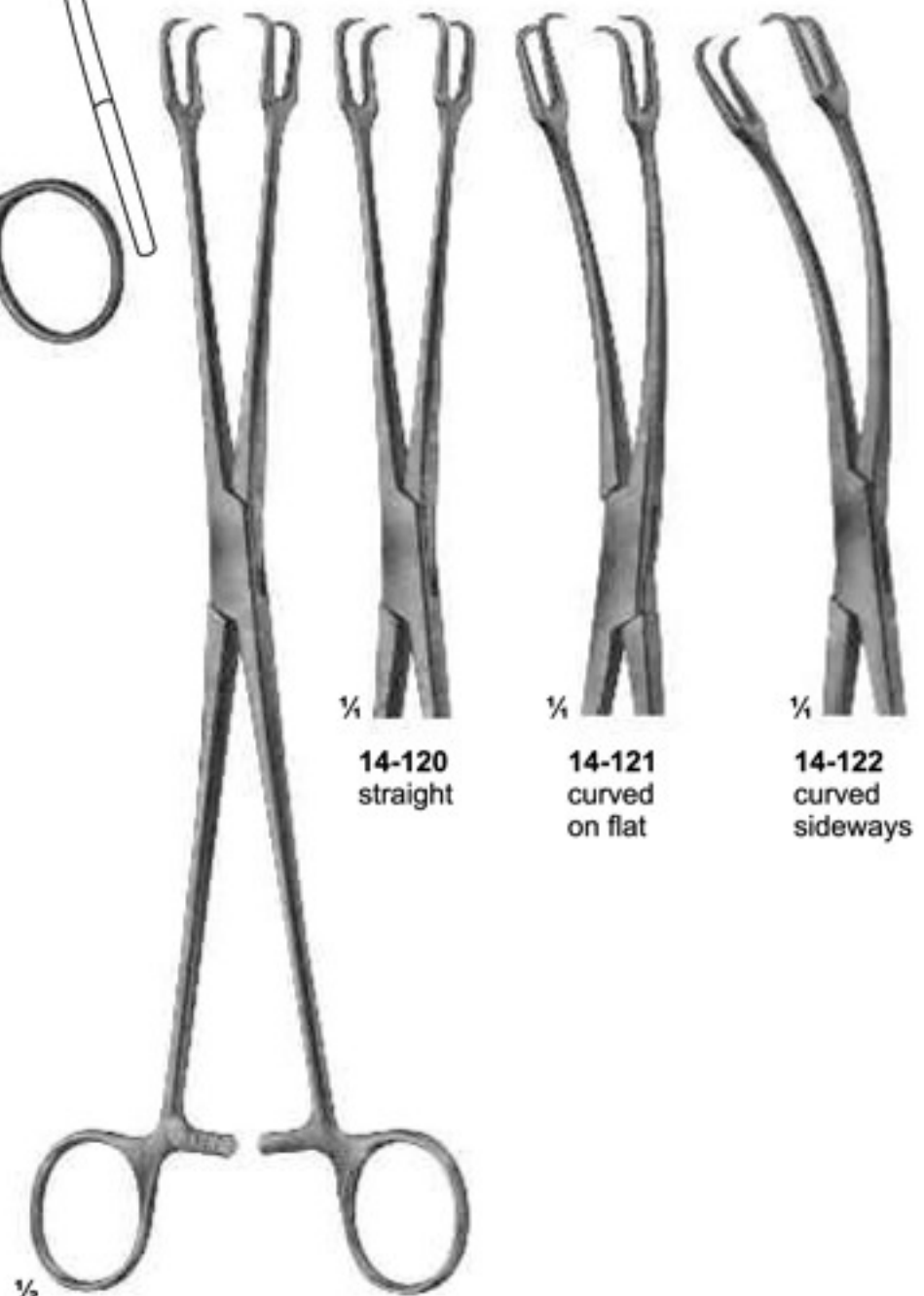

14-120
straight

14-121
curved
on flat

14-122
curved
sideways

14-120 - 122
SCHRODER
250 mm

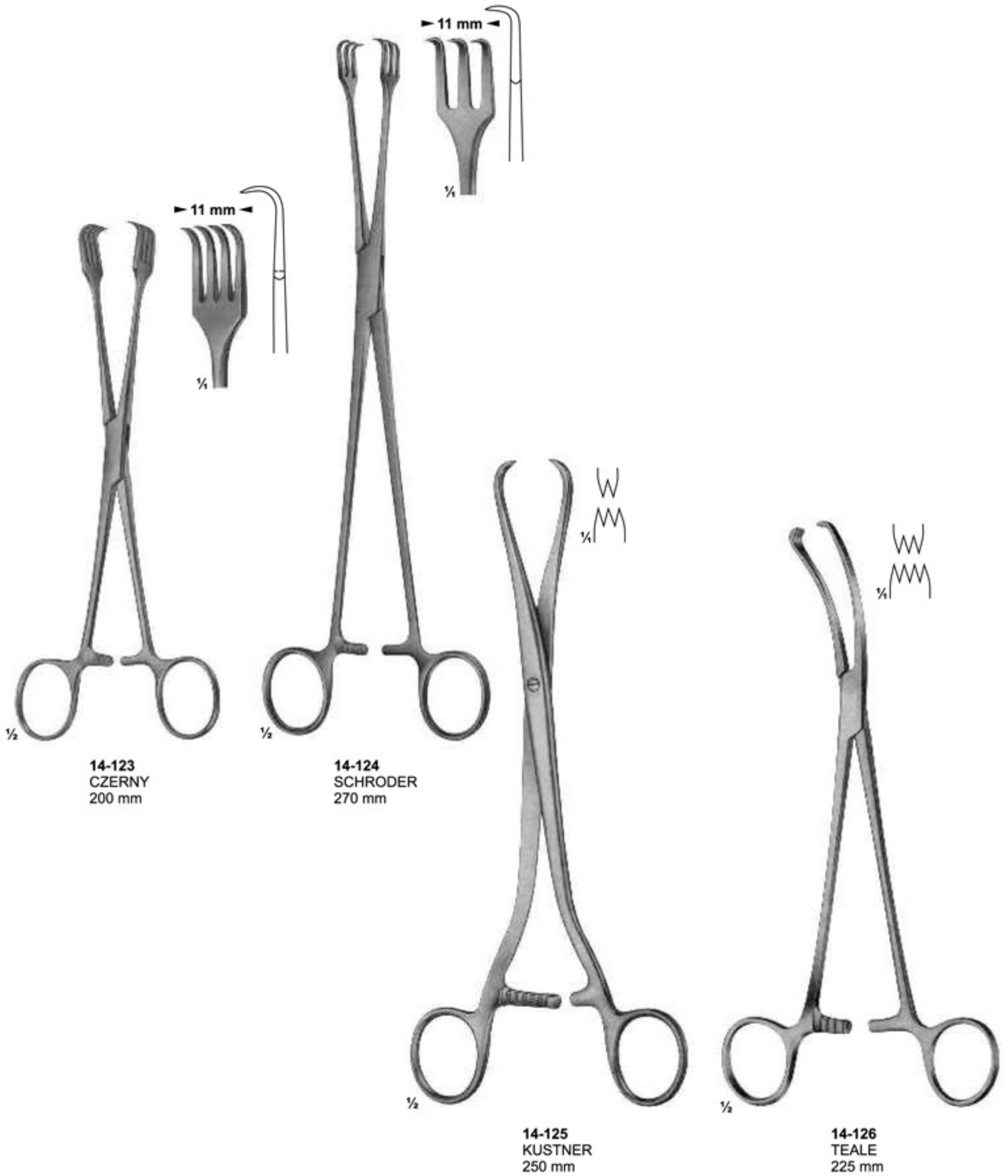

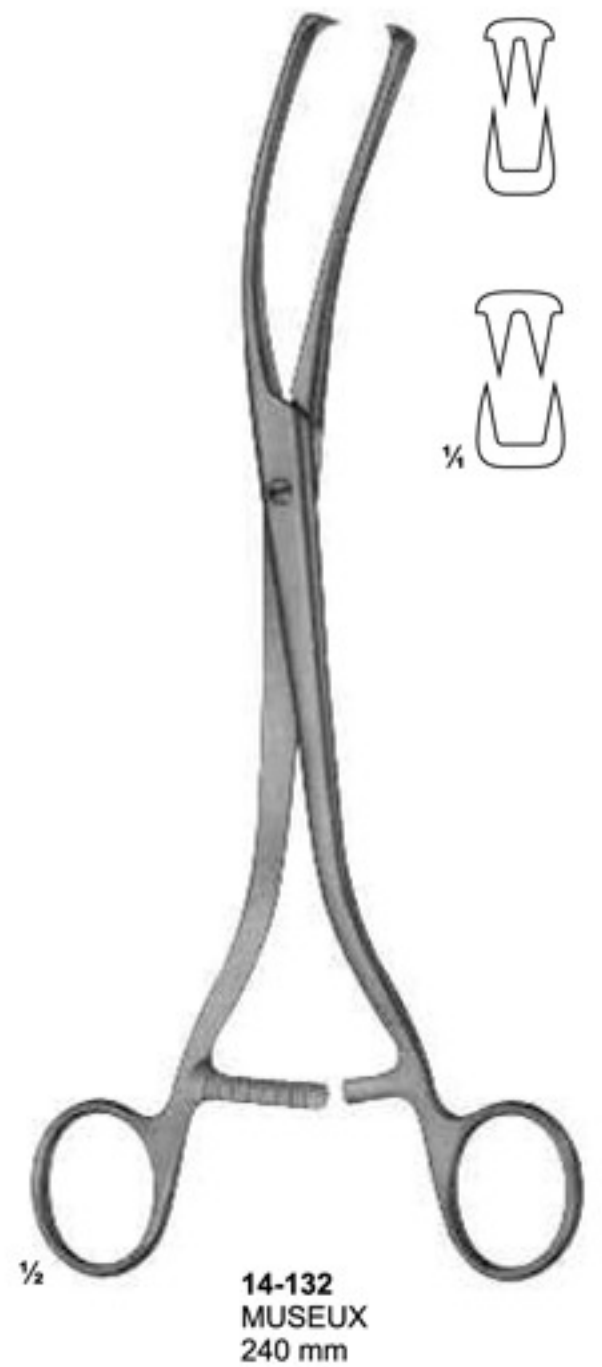
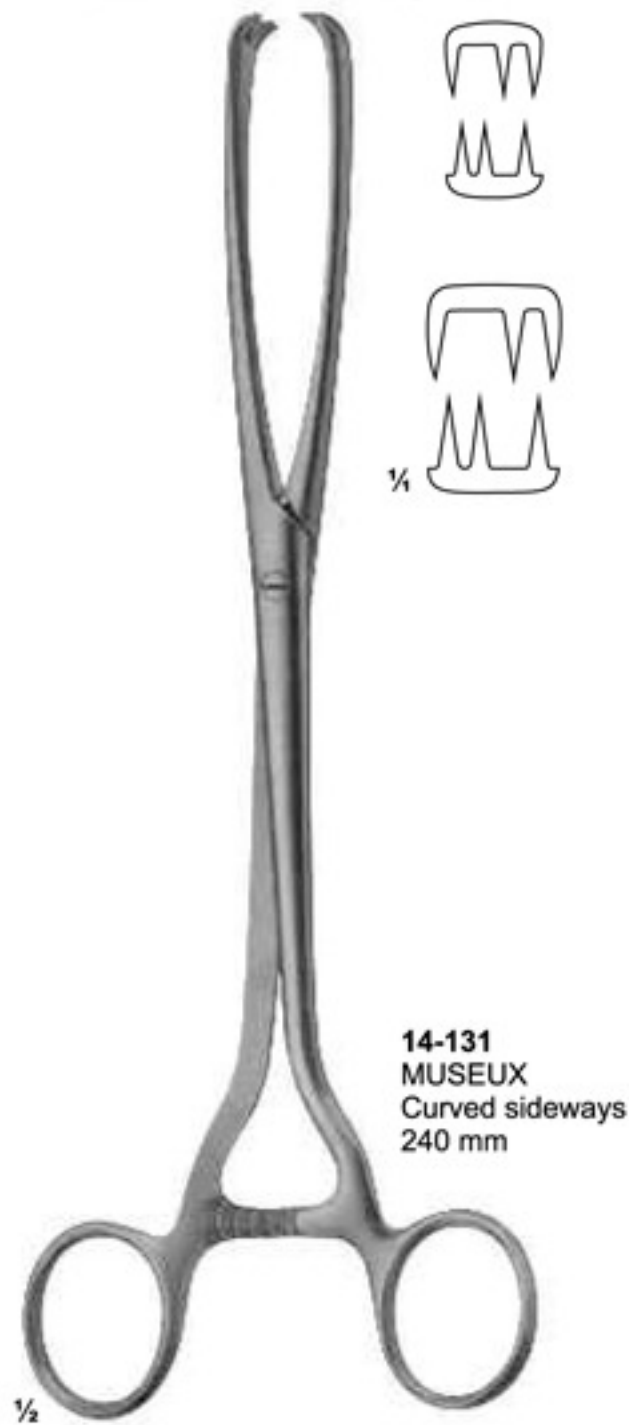
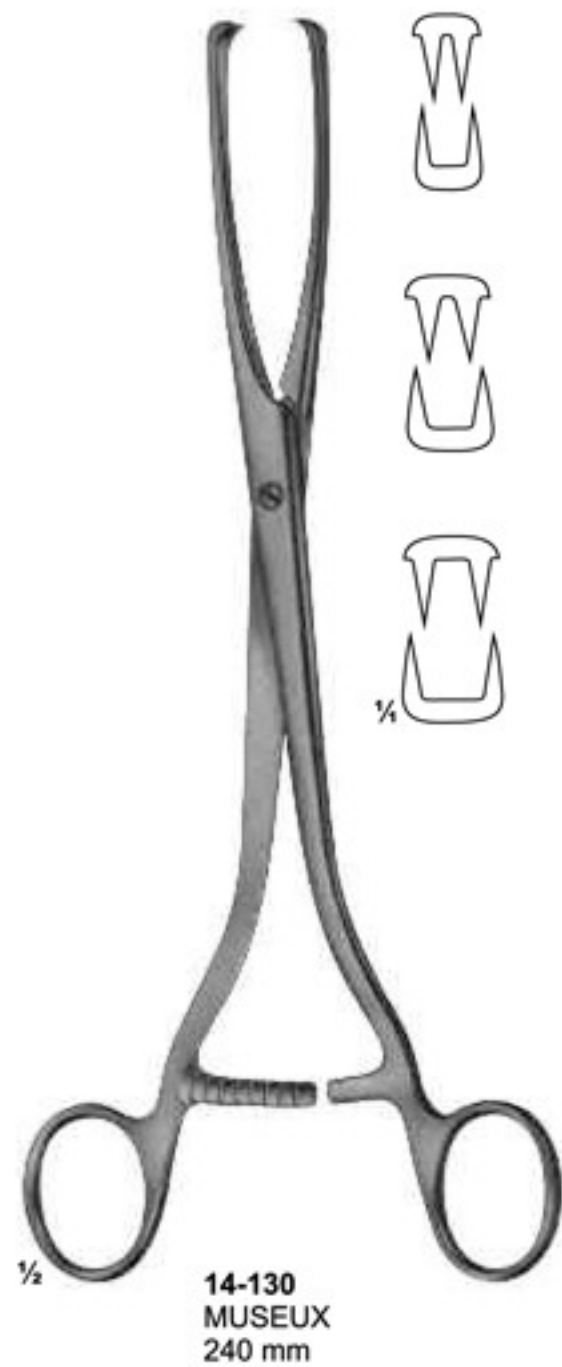

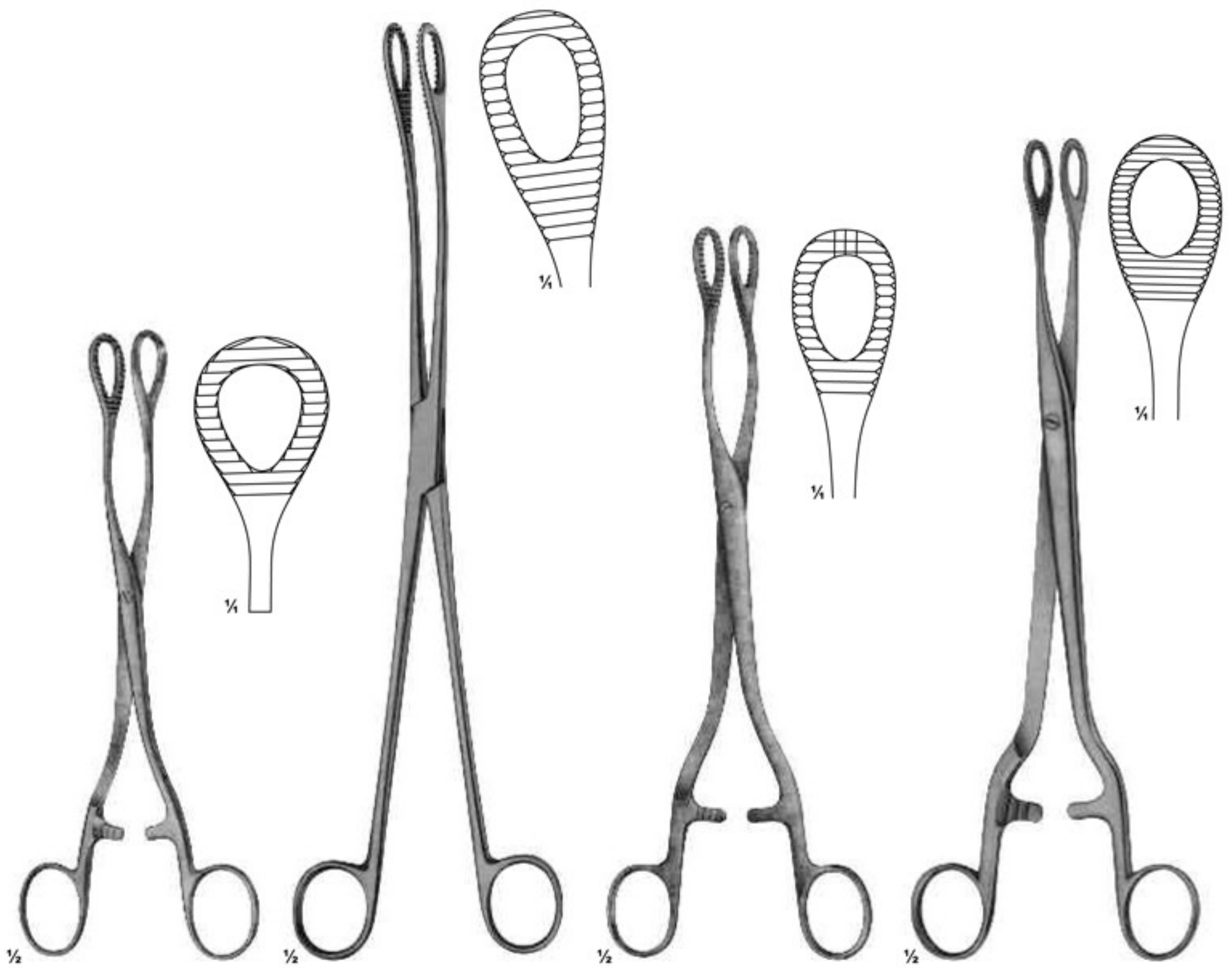

14-133
HEYWOOD-SMITH
200 mm

14-134
KELLY
320 mm

14-135
HEYWOOD-SMITH
250 mm

14-136
NOTO
280 mm



1/4



1/4



1/4



1/4

14-138

14-139



1/2

14-137
DOYEN
185 mm



1/2

14-138 - 139
250 mm 270 mm



1/2

14-140
BUMM
280 mm

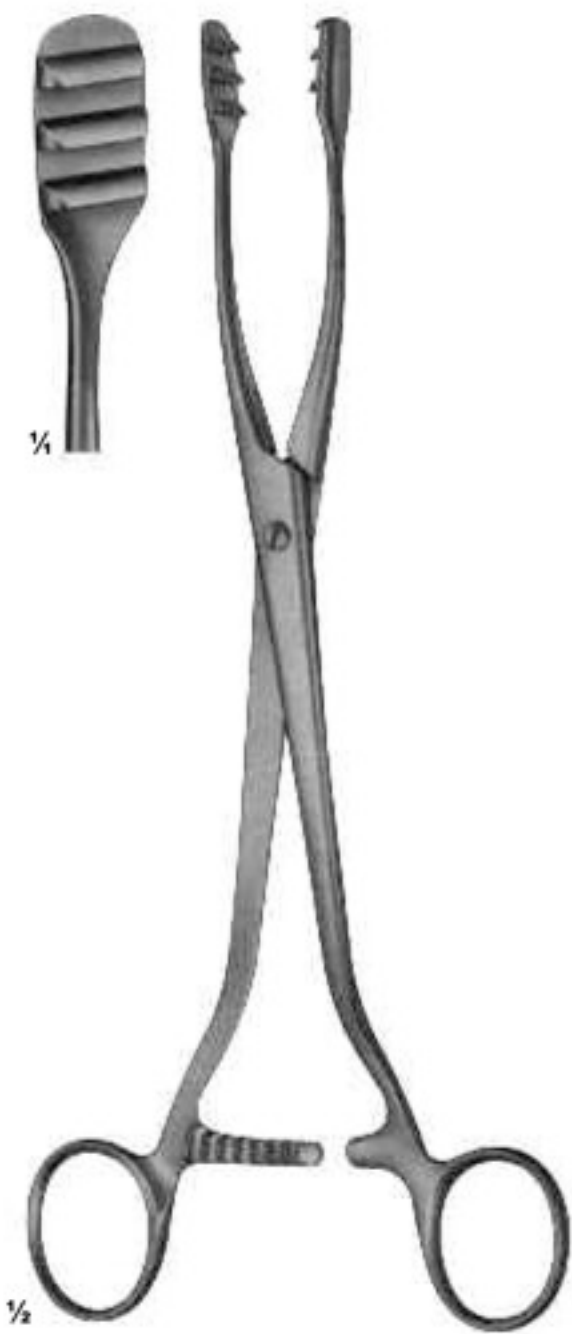

14-141
COLLIN
250 mm



14-142
COLLIN
285 mm



14-143
DARTIGUES
255 mm



14-144
SOMER
235 mm



14-145
STRASSMANN
260 mm

With movable jaws



14-146
COLLIN
265 mm

With movable jaws



14-147
260 mm



14-148
SEGOND
Myomatome
270 mm



14-149
DOYEN
Myoma screw
150 mm



14-150
DOYEN
Myoma screw
190 mm

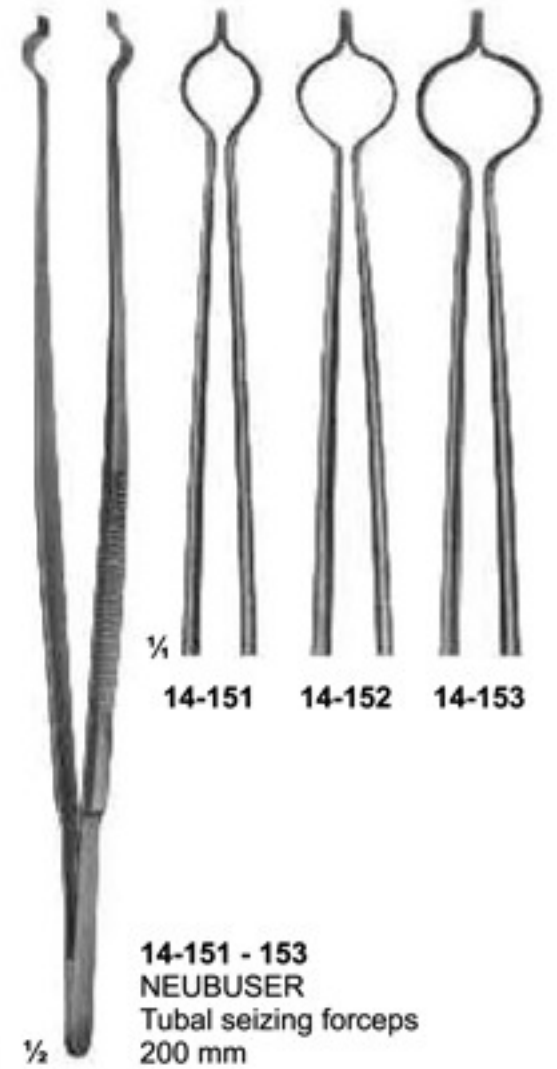

14-151 - 153
NEUBUSER
Tubal seizing forceps
200 mm



14-154
Splint guide
with thread



14-155
Splint guide with
round handle
180 mm



14-156
Angled glass rods
Set . 3 pieces



14-157
Silicon operating pad
pre-cut



14-158
Polyethylene splint material
soft-sterile
0.45 mm

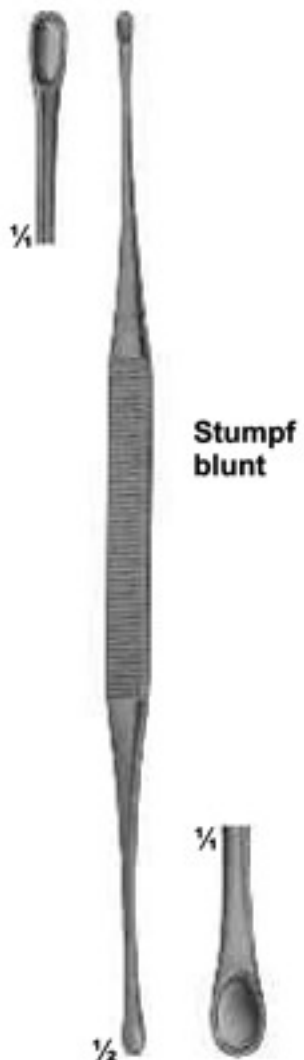

15-101
ASCH
Uterine
Secretion scoop
200 mm

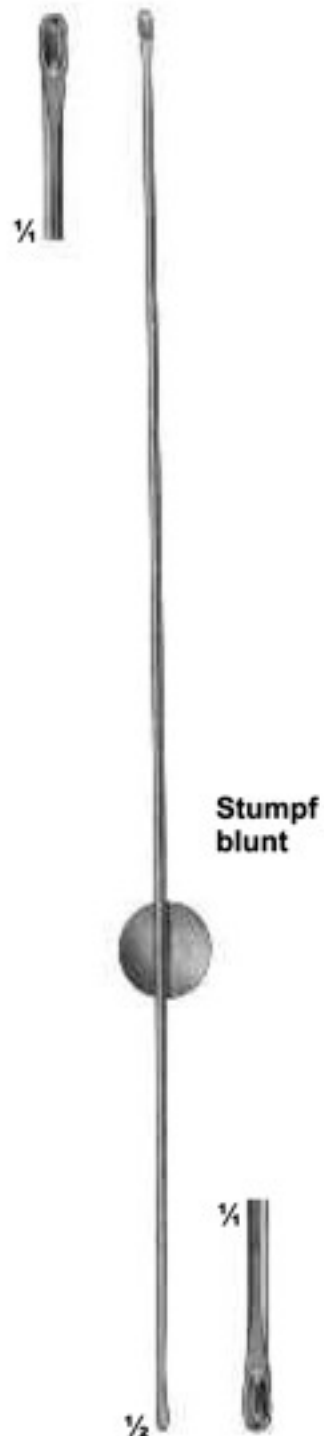

15-102
Uterine
Secretion scoop
270 mm



15-103
NOVAK-SCHOECKAERT
Endometrial biopsy
curette
240 mm



15-104
RANDALL
Endometrial biopsy
curette
240 mm

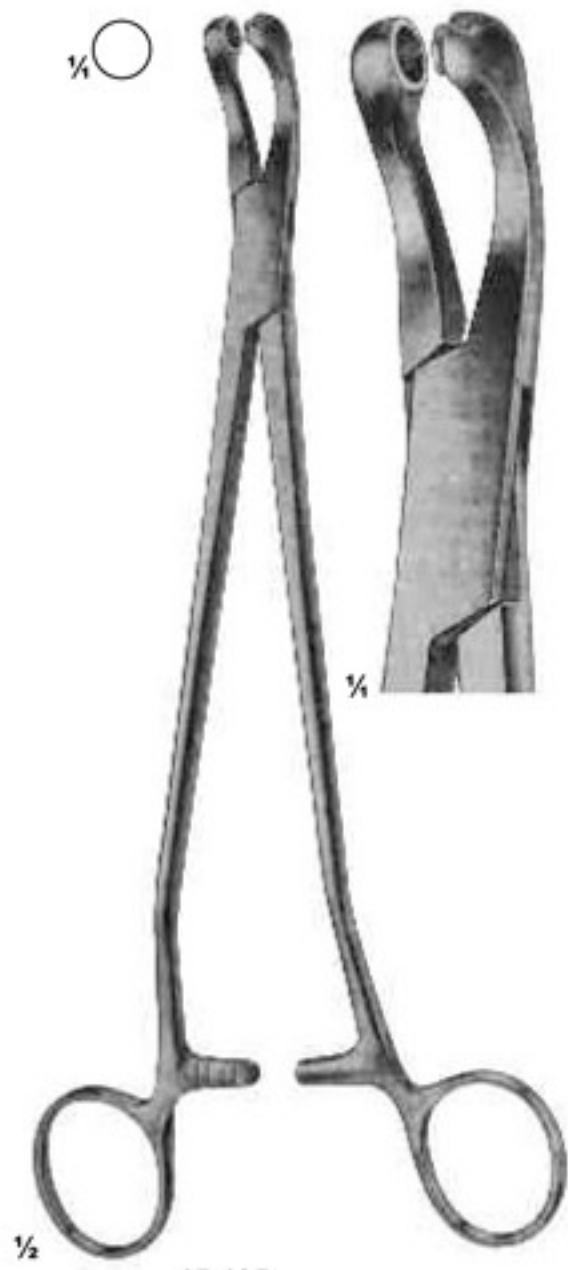

15-105
THOMS-GAYLOR
240 mm



15-106
SCHUBERT
260 mm

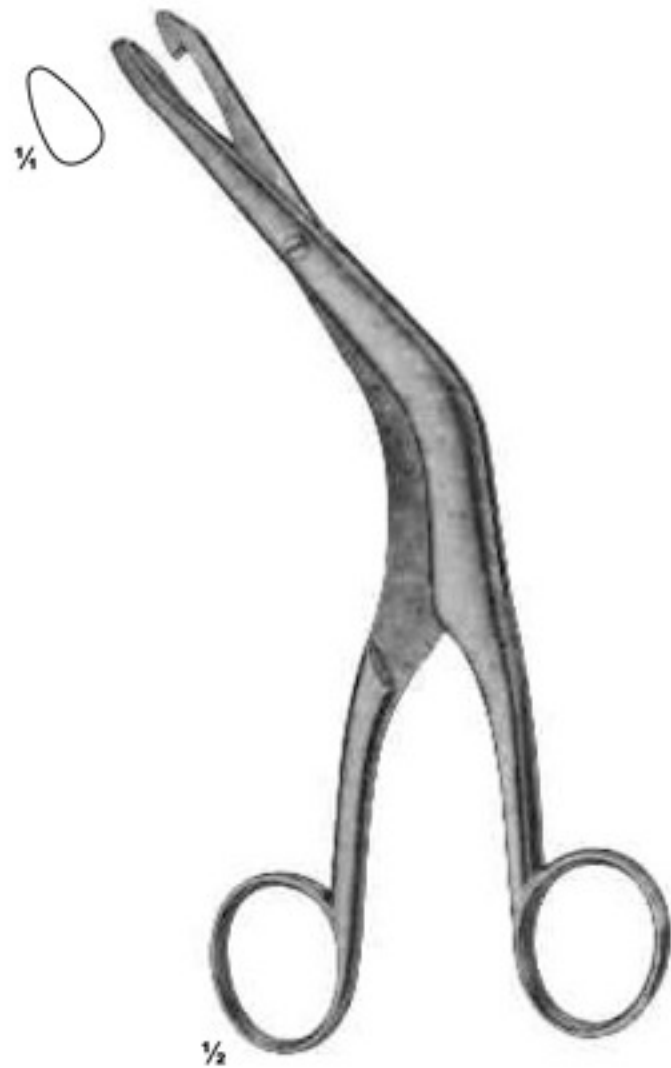

15-107
FAURE
210 mm

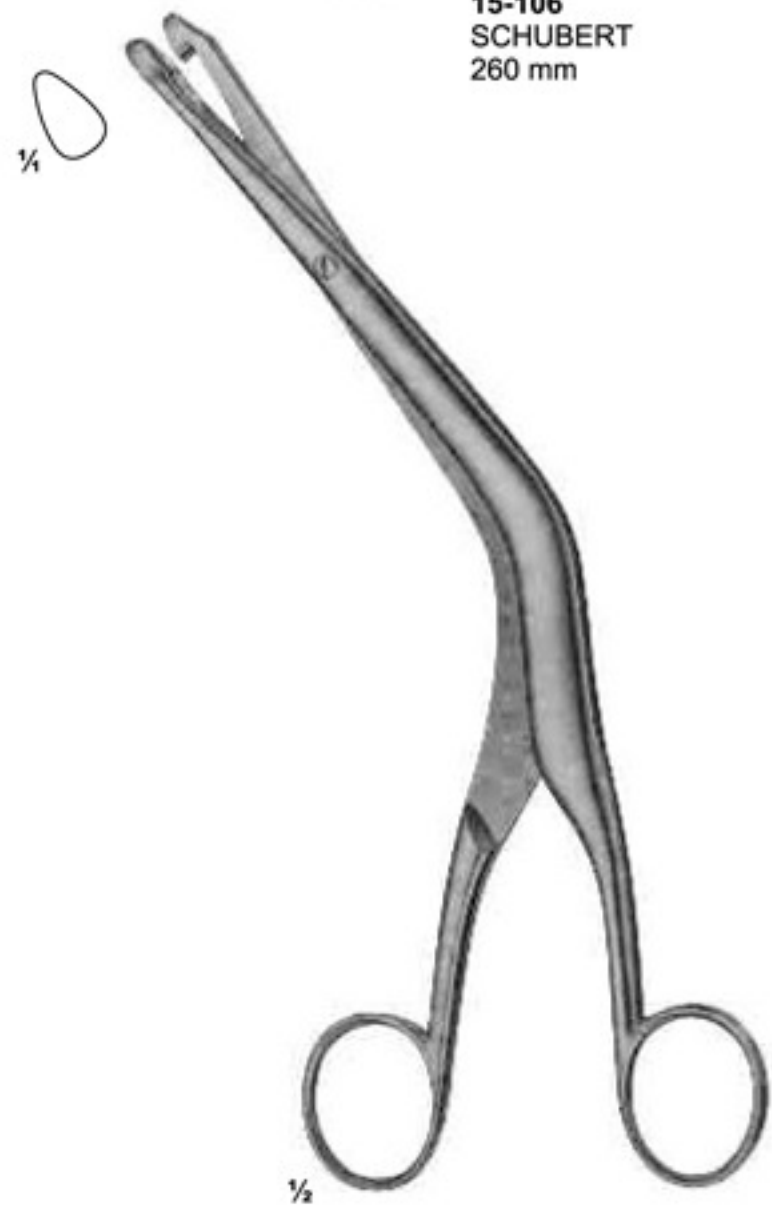

15-108
FAURE
240 mm

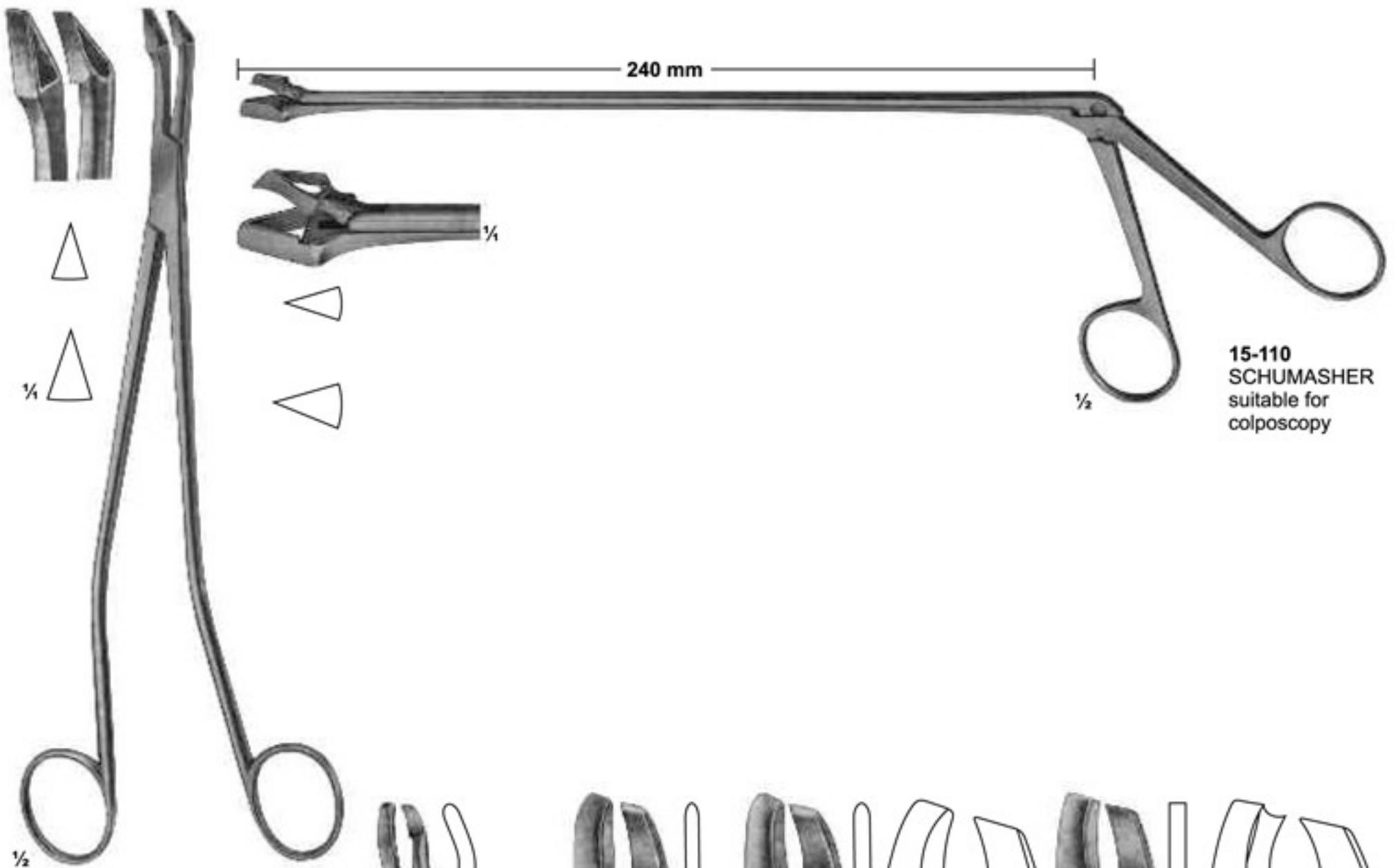

15-110
SCHUMASHER
suitable for
colposcopy

15-109
SCHUMASHER
240mm

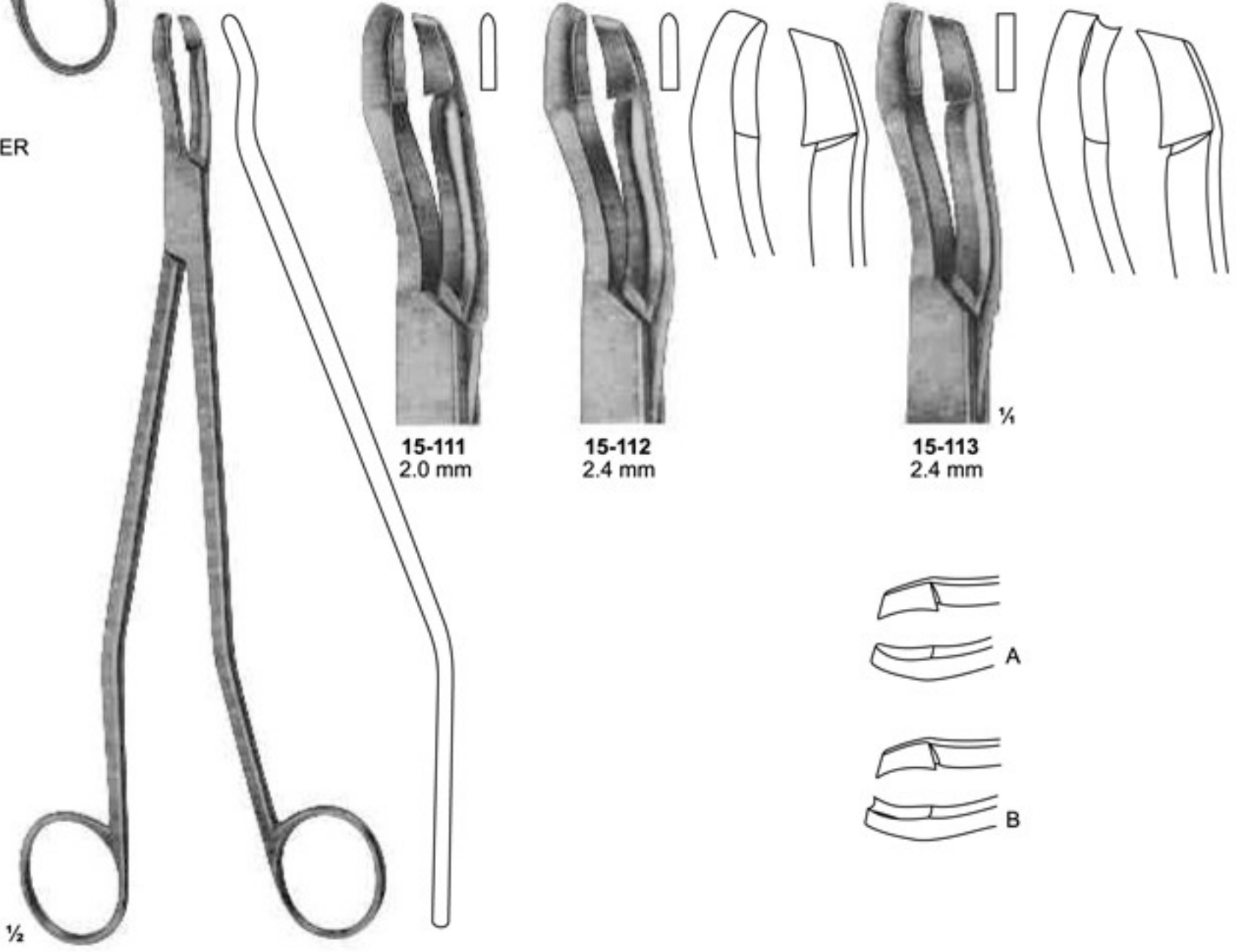

15-111 - 113
SEIDL DBP
Biopsy forceps, bayonet shaped
for portio, vagina and vulva
240mm

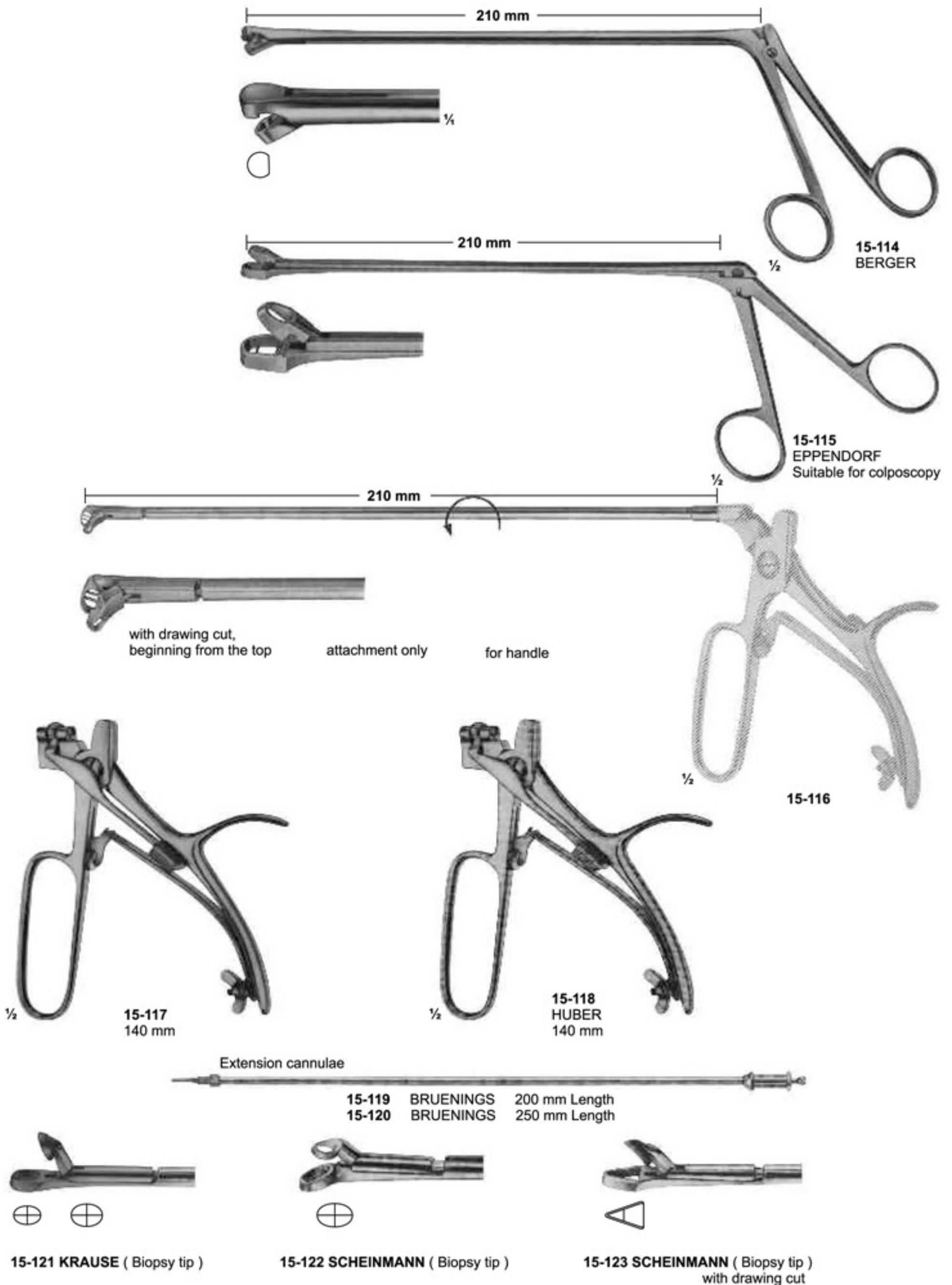

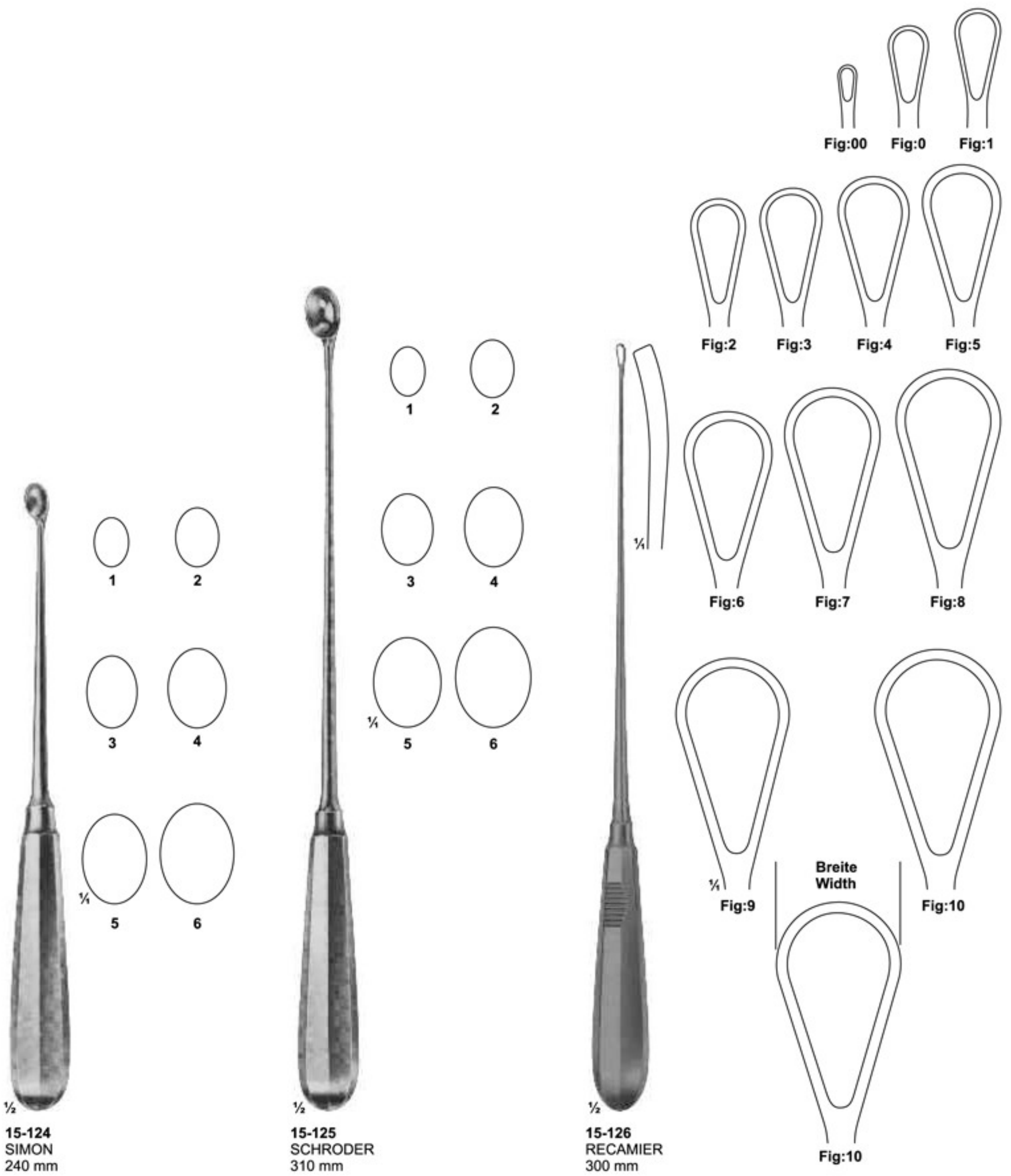

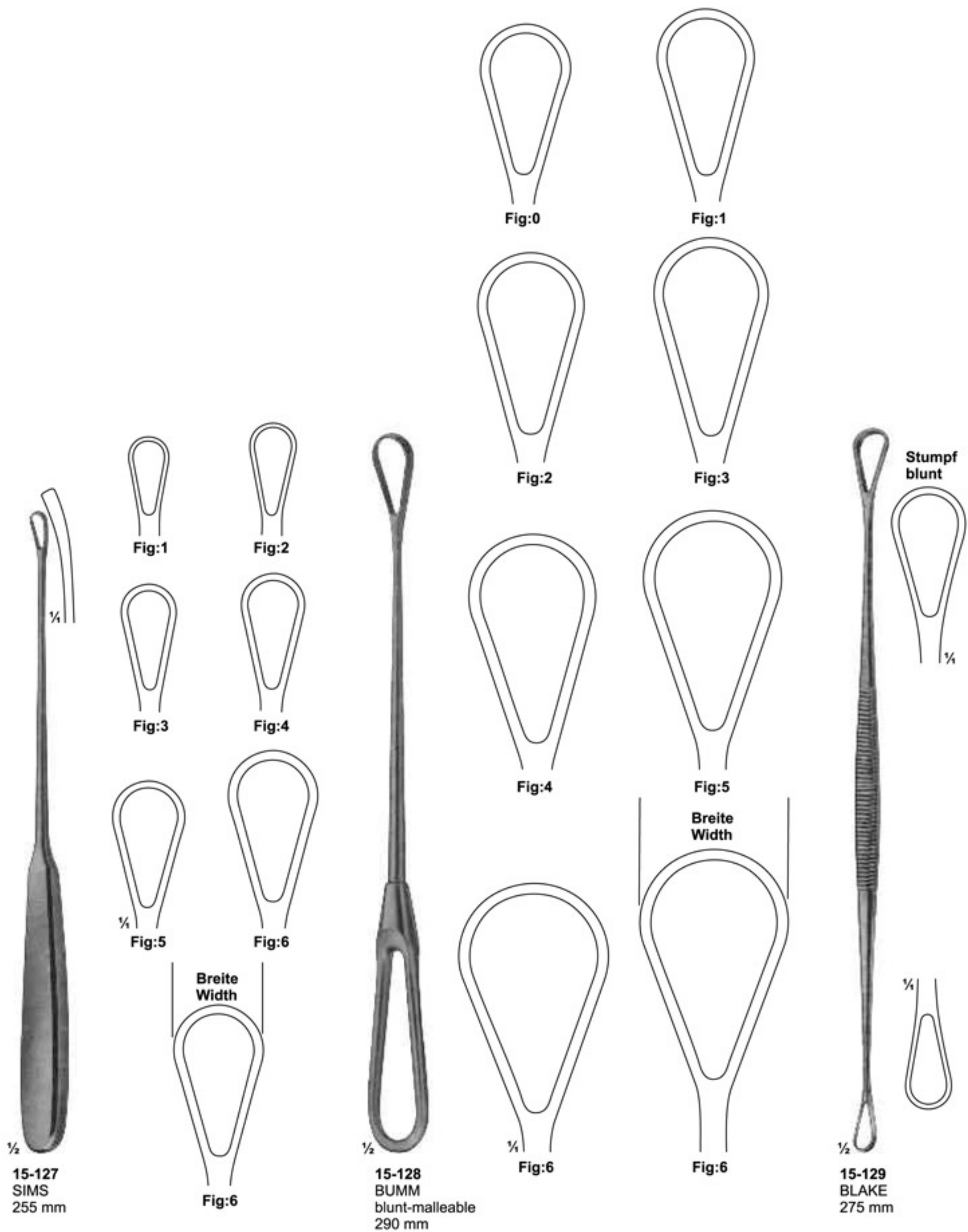

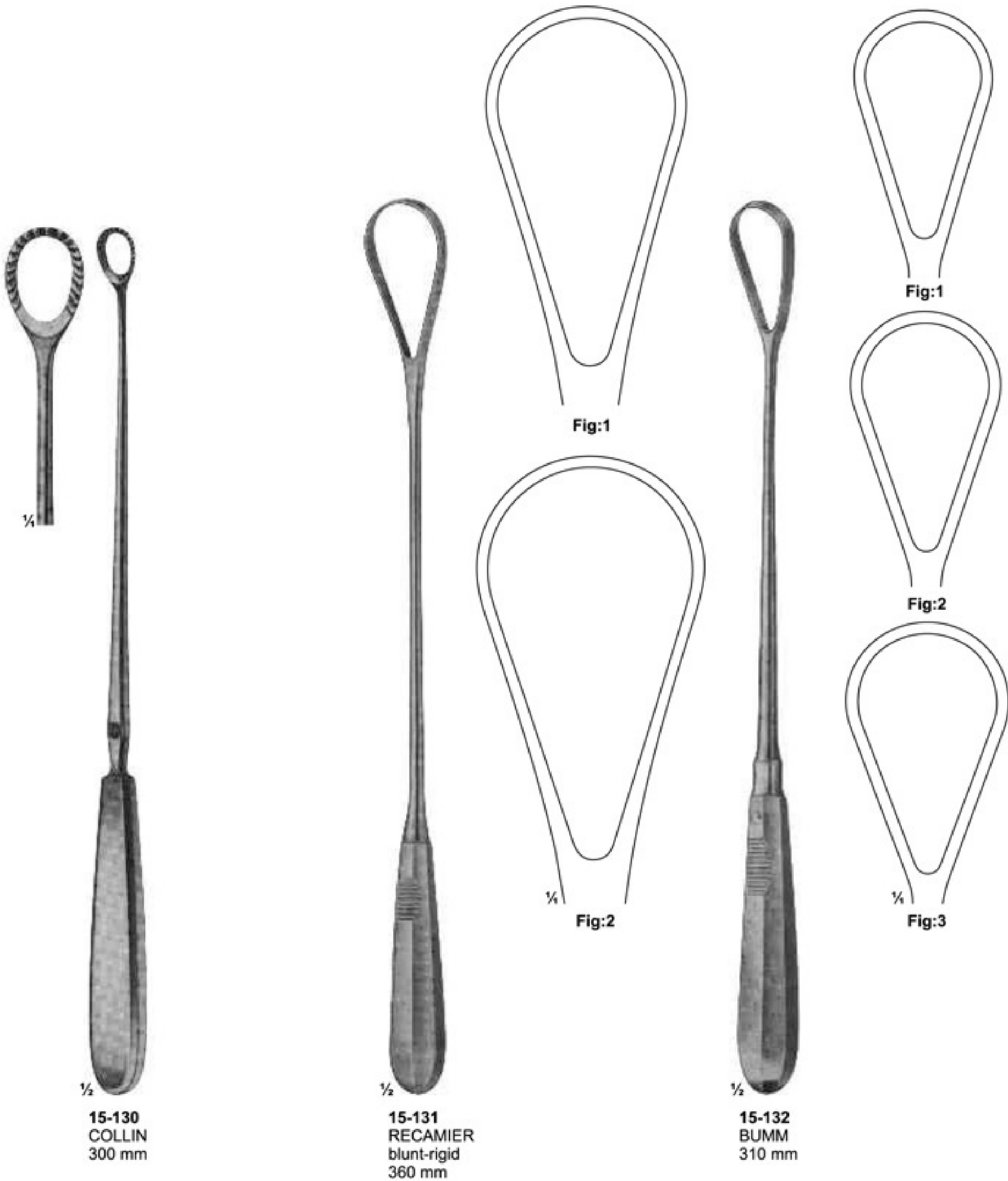

15-133 - 138

Suction currettes, stainless steel, fitting hose connection.

Working tips are smoothly rounded of, therefore no danger of perforation.

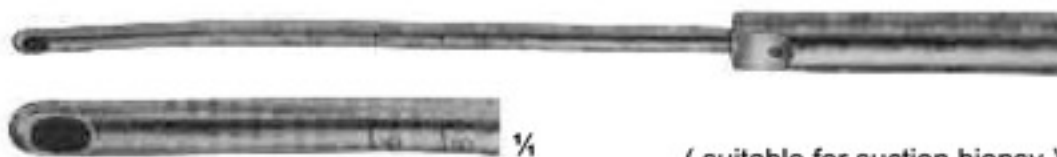

(suitable for suction biopsy)

- 15-133: diam 4 mm
- 15-134: diam 6 mm
- 15-135: diam 8 mm
- 15-136: diam 10 mm
- 15-137: diam 12 mm
- 15-138: diam 14 mm

15-139

Hose connection inside diam. 11 mm curved stainless steel.



15-140

The new connection between suction curette and hose connection, Guarantees quick changing and free turning of the suction currettes on the hose connection.

15-141

Transparent suction hose 1.8 m long, inside diam 11 mm, outside diam 16.5 mm can be sterilized in an autoclave at 1 bar overpressure (120 C)



15-142

Strainer for tissues, plastic, for single use only, to be used for histopathological examination.



15-143 diam 8 mm
15-144 diam 10 mm
BOZEMANN-FRITSCH
Uterine Flushing Tube
350 mm

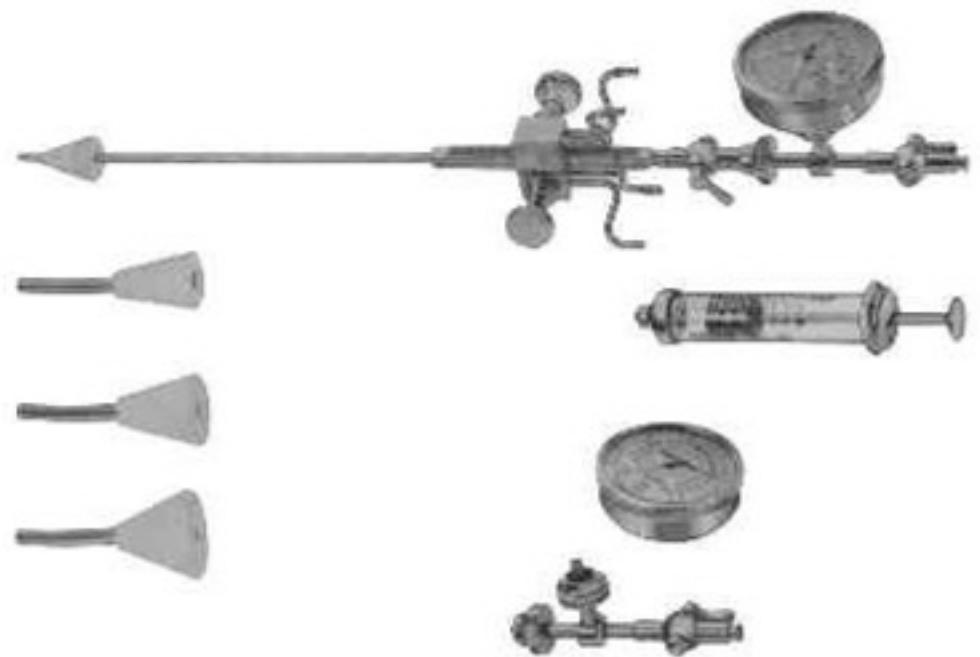

15-145
SCHULZE
Salpingograph, for utero-salpingography
in wooden case, consisting of:
Manometer, Connection, Uterine canulla
with tap, Cone S.M.L.,
Record Syringe 10 cc, Luer lock mount.



15-146
SCHULZE
Salpingograph, equipment
without manometer.



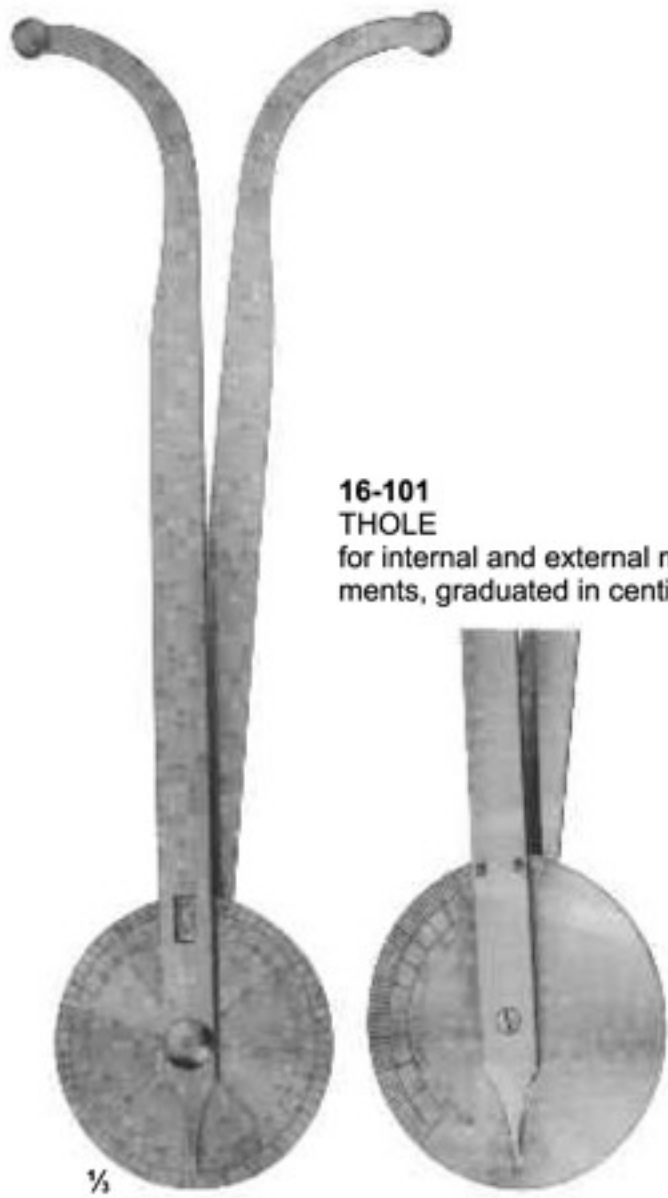

16-101
THOLE
for internal and external measurements, graduated in centimeters



16-102
DE LEE
graduated in centimeters and inches



16-103
COLLIN
graduated in centimeters



16-104
MARTIN
graduated in centimeters



16-105
COLLIN
graduated in centimeters

The additional straight arm can be replaced. The pelvimeter with straight arm is used for localisation of the portio vaginalis uteri and of vaginal metastasis.



16-106
BREISKY
graduated in centimeters

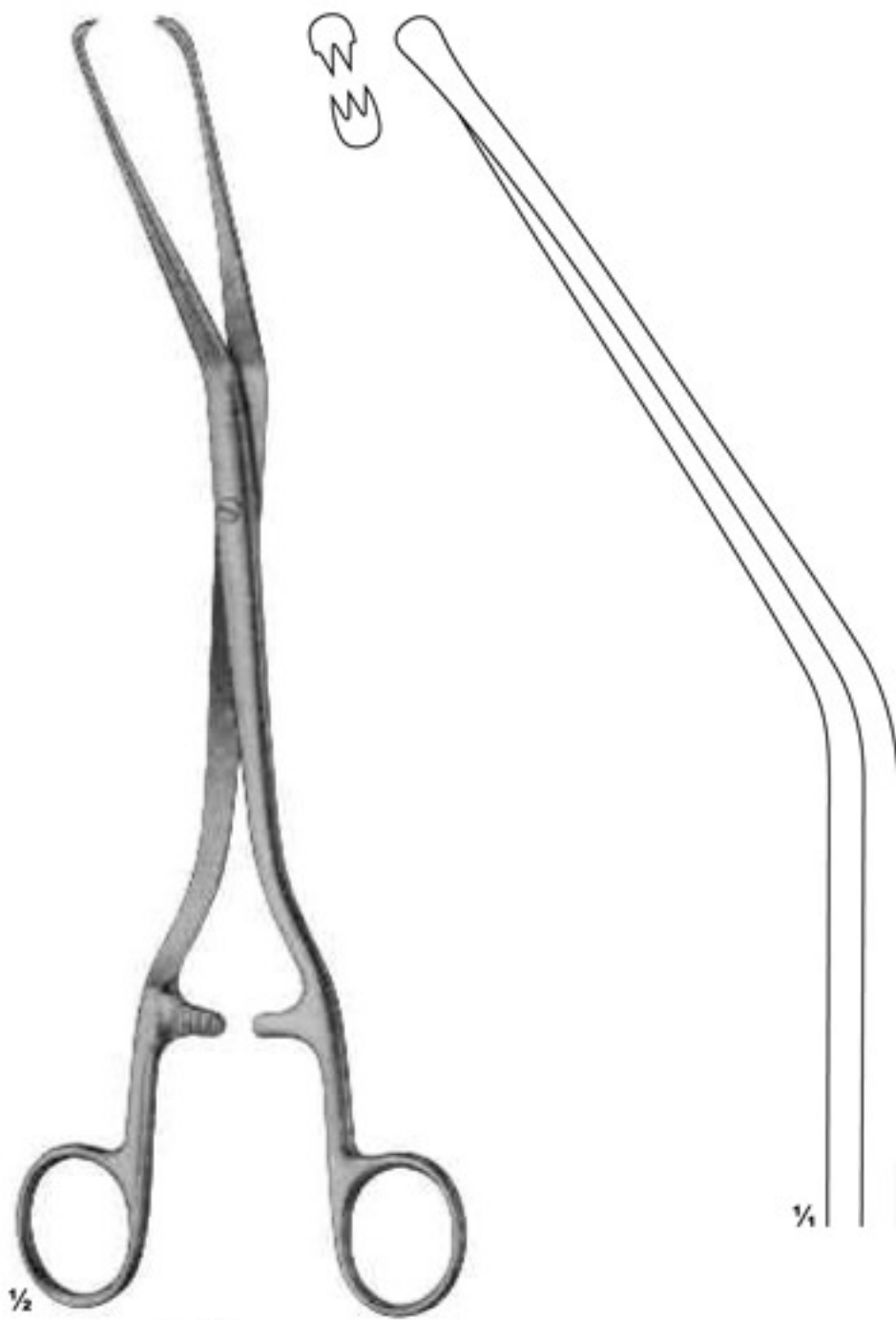

16-107
HERFF
puncturing forceps
225 mm



16-108
IOWA
puncturing forceps
260 mm



1/2
16-109
SCHUMACHER
Umbilical cord
scissors
155 mm



1/2
16-110
Umbilical cord
scissors
105 mm

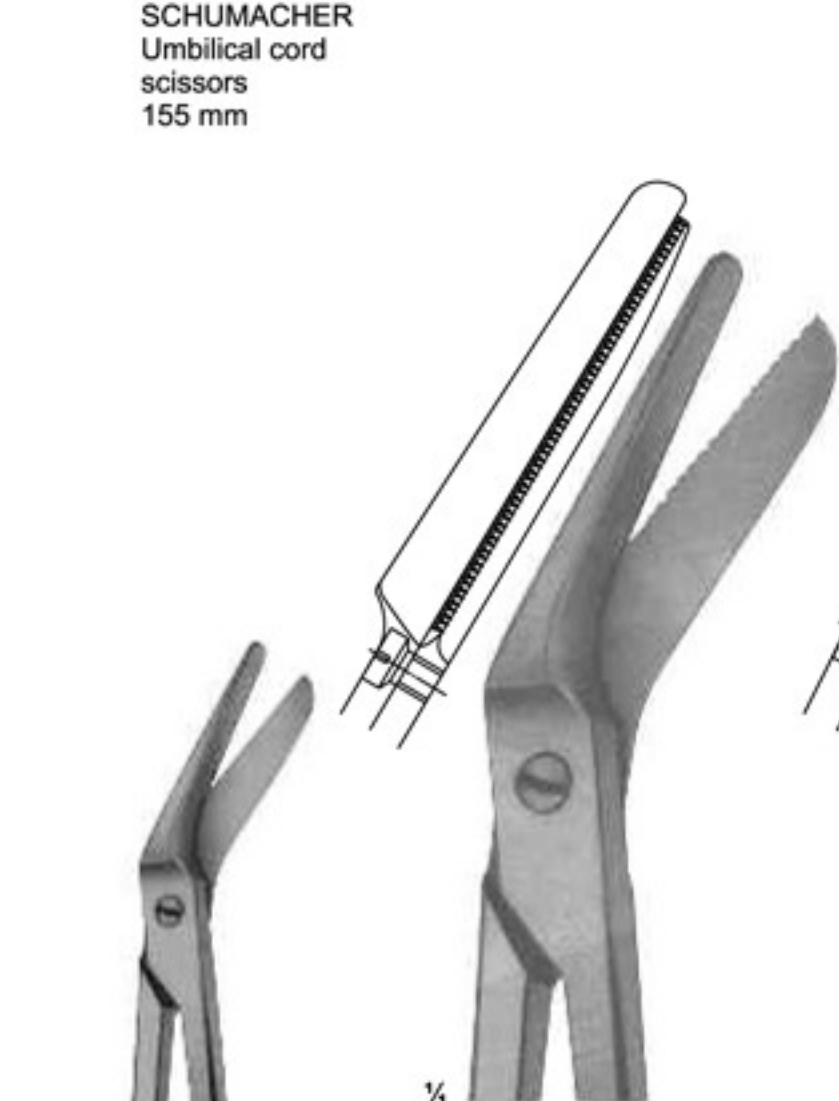

1/2
16-111 - 112
BRAUN-STADLER
Episiotomy Scissors

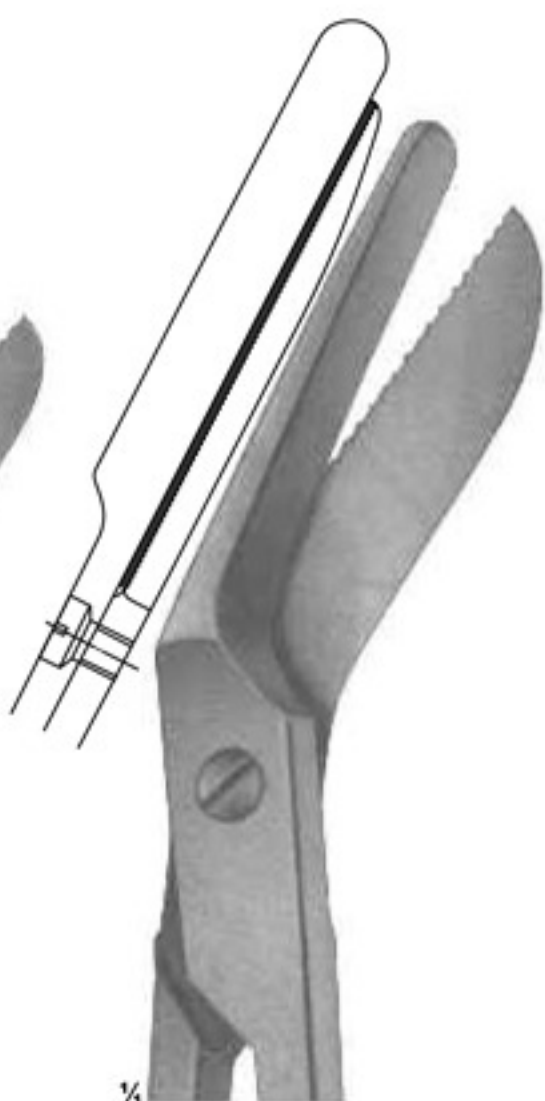

1/4
16-112
200 mm

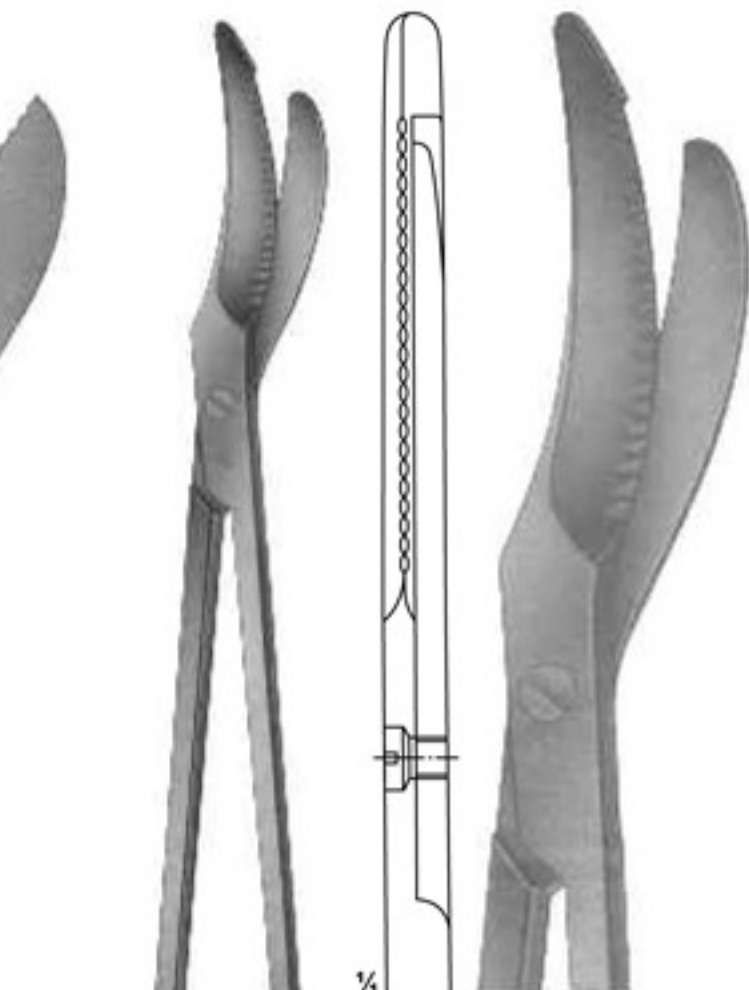

1/2
16-113
Episiotomy Scissors
240 mm



16-114
355 mm



16-115
400 mm



16-116
SIMPSON-BRAUN
305mm



16-117
SIMPSON-BRAUN
305mm



16-118
SIMPSON
235mm



16-119
WRIGLEY
250 mm



16-120
GREEN-ARMYTAGE
 Caesarean section haemostatic
 forceps, for edges of the transverse
 incision in the lower segment
 220 mm



16-121
WILLETT
 Scalpel Flap forceps
 185 mm

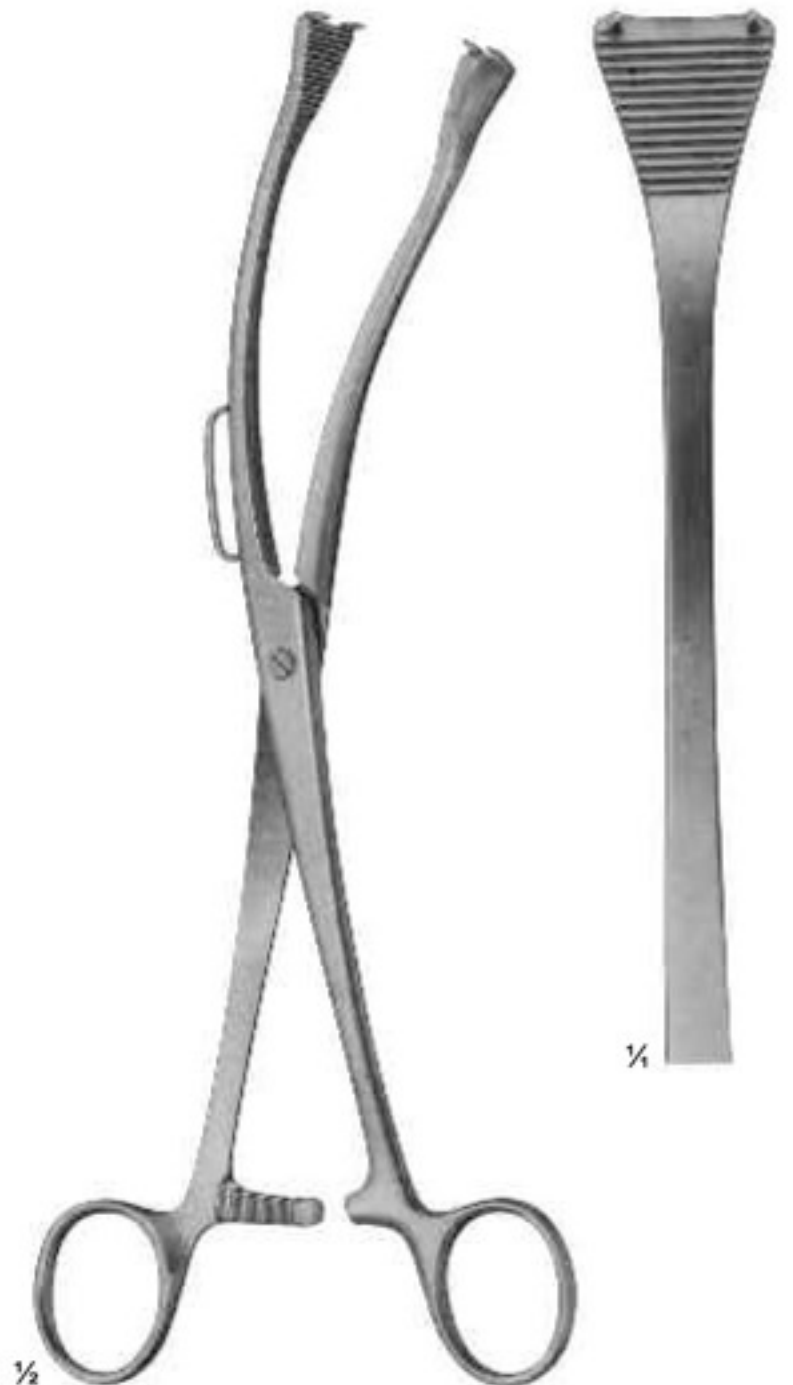

16-122
GAUSS
 Scalpel Flap forceps
 260 mm

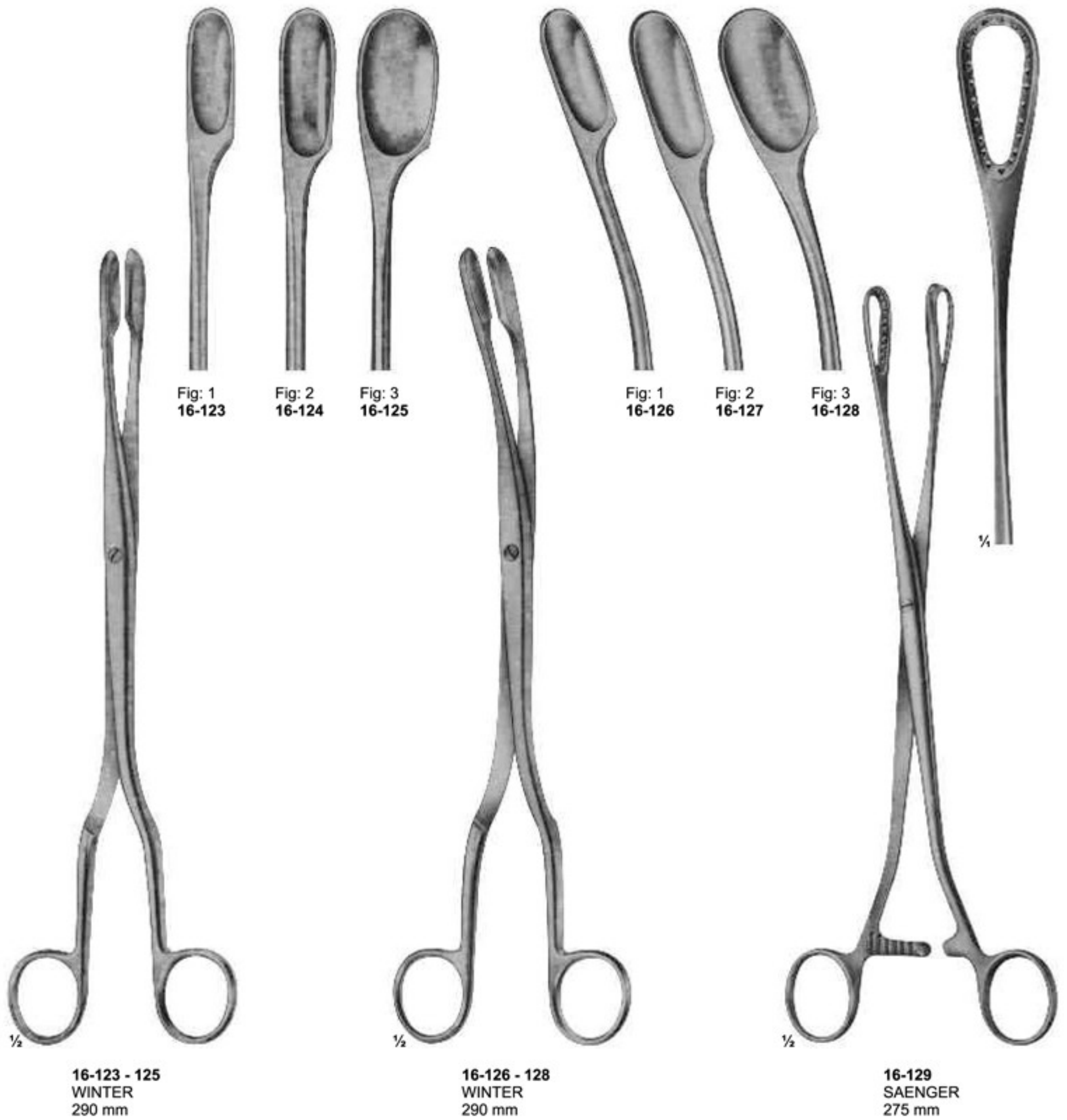

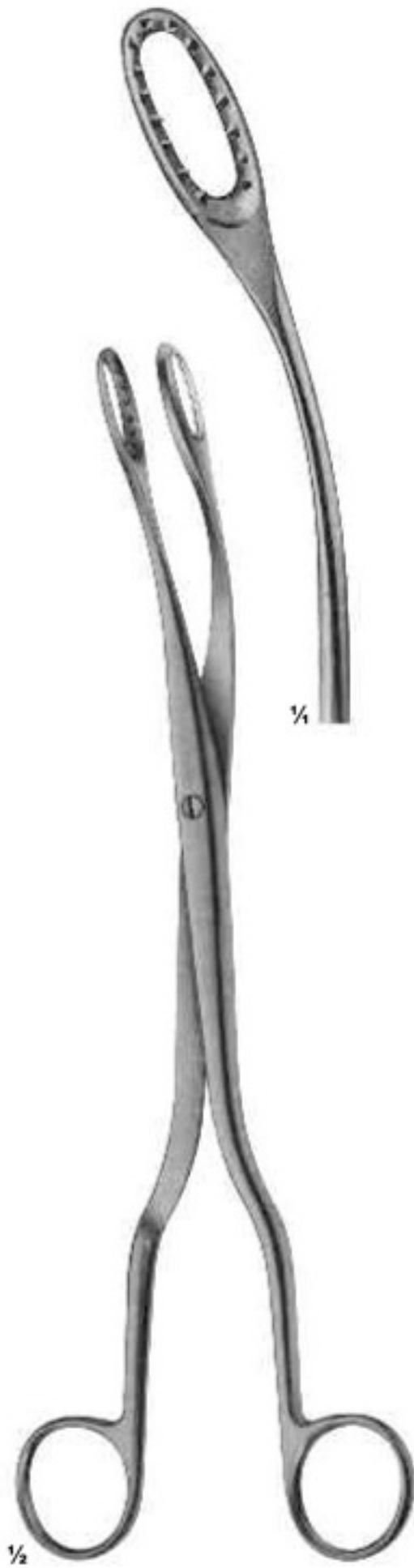

16-130
SAENGER
285 mm

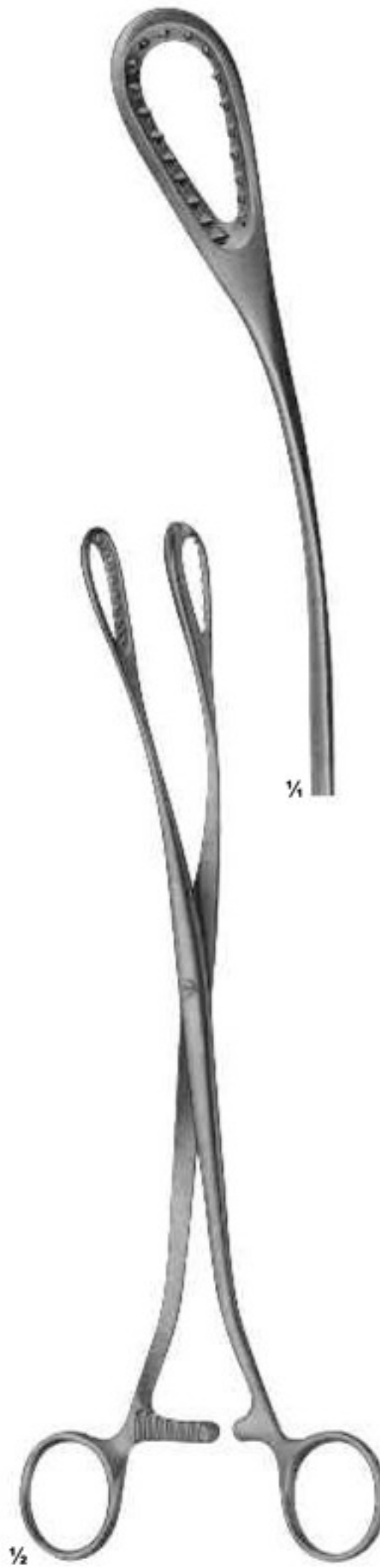

16-131
SAENGER
285 mm



16-132 - 133
LEWKOWIZ
245 mm

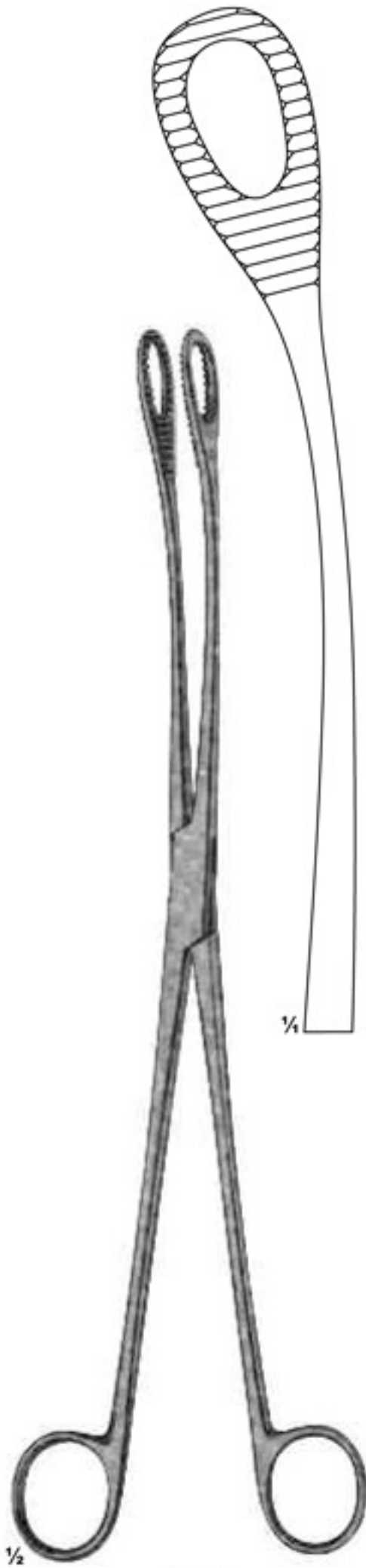

16-134
KELLY
320mm



16-135
SMELLIE
Perforator
270mm



16-136
BRAUN
Cranioclast
420mm



1/2

16-137
UECKERMANN-DENKER
 Cryothyrotomy trocar
 with silver cannula
 130mm

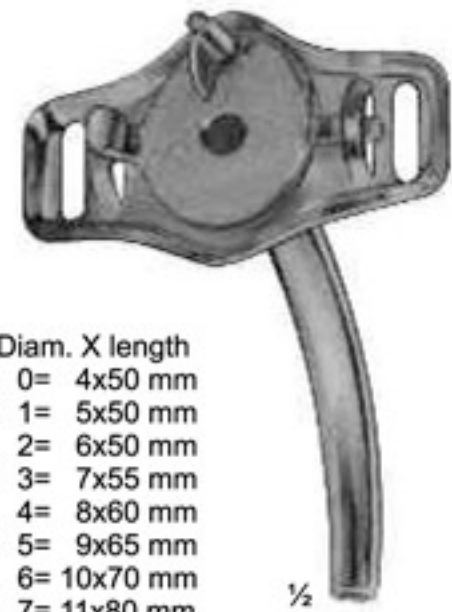

1/2

Diam. X length
16-138 Fig. 0= 4x50 mm
16-139 Fig. 1= 5x50 mm
16-140 Fig. 2= 6x50 mm
16-141 Fig. 3= 7x55 mm
16-142 Fig. 4= 8x60 mm
16-143 Fig. 5= 9x65 mm
16-144 Fig. 6= 10x70 mm
16-145 Fig. 7= 11x80 mm
16-146 Fig. 8= 12x85 mm
16-147 Fig. 9= 13x90 mm
16-148 Fig. 10=14x90 mm

16-138 - 148
LUER
 German silver



1/2

16-149 - 158
JACKSON
 German Silver

Diam. X length
16-149 Fig. 0= 4x50 mm
16-150 Fig. 1= 5x58 mm
16-151 Fig. 2= 6x58 mm
16-152 Fig. 3= 7x70 mm
16-153 Fig. 4= 8x78 mm
16-154 Fig. 5= 9x84 mm
16-155 Fig. 6= 10x84 mm
16-156 Fig. 7= 11x86 mm
16-157 Fig. 8= 12x88 mm
16-158 Fig. 9= 13x90 mm



1/2

Diam. X length
16-159 Fig. 1= 5x48 mm
16-160 Fig. 2= 6x58 mm
16-161 Fig. 3= 7x70 mm
16-162 Fig. 4= 8x78 mm
16-163 Fig. 5= 9x84 mm
16-164 Fig. 6= 10x84 mm
16-165 Fig. 7= 11x86 mm
16-166 Fig. 8= 12x88 mm
16-167 Fig. 9= 13x90 mm
16-168 Fig.10= 14x90 mm

16-159 - 168
JACKSON
 German Silver



16-169
BOSE
165 mm



16-170
BOSE
165 mm



16-171 - 173
180 mm



16-171
sharp



16-172
blunt



16-173
stumpf/blunt

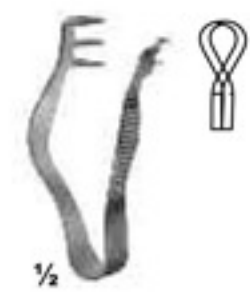

16-174
FINSEN
50 mm



16-175
FINSEN
70 mm



16-176
TROUSSEAU
120 mm



16-177
LABORDE
125 mm



16-178
LABORDE
strong pattern
135 mm



16-179
Cleaning Brush
for tracheal tubes
285 mm

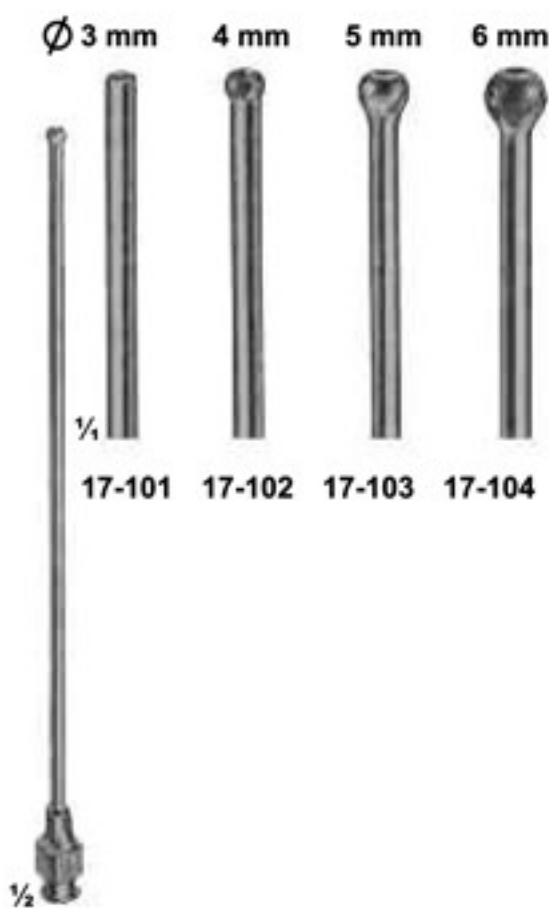

17-101 - 104
SCHMID
 Vessel irrigating cannulae,
 malleable, silver plated
 150 mm



17-105
BLAKE
 Embolus grasping
 forceps
 205 mm

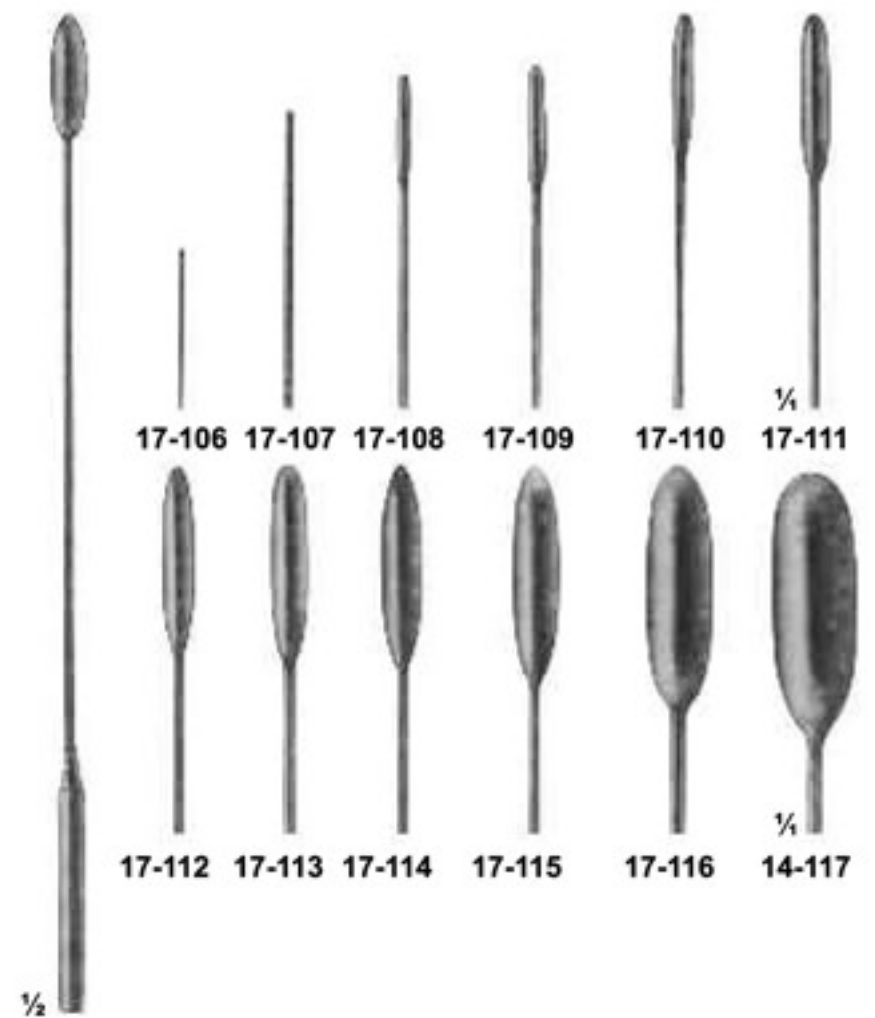

17-106 - 117
DE BAKEY
 Vascular dilators,
 malleable
 190 mm

17-106 0,5 mm Ø	17-112 3,5 mm Ø
17-107 1,0 mm Ø	17-113 4,0 mm Ø
17-108 1,5 mm Ø	17-114 4,5 mm Ø
17-109 2,0 mm Ø	17-115 5,0 mm Ø
17-110 2,5 mm Ø	17-116 7,0 mm Ø
17-111 3,0 mm Ø	17-117 9,0 mm Ø

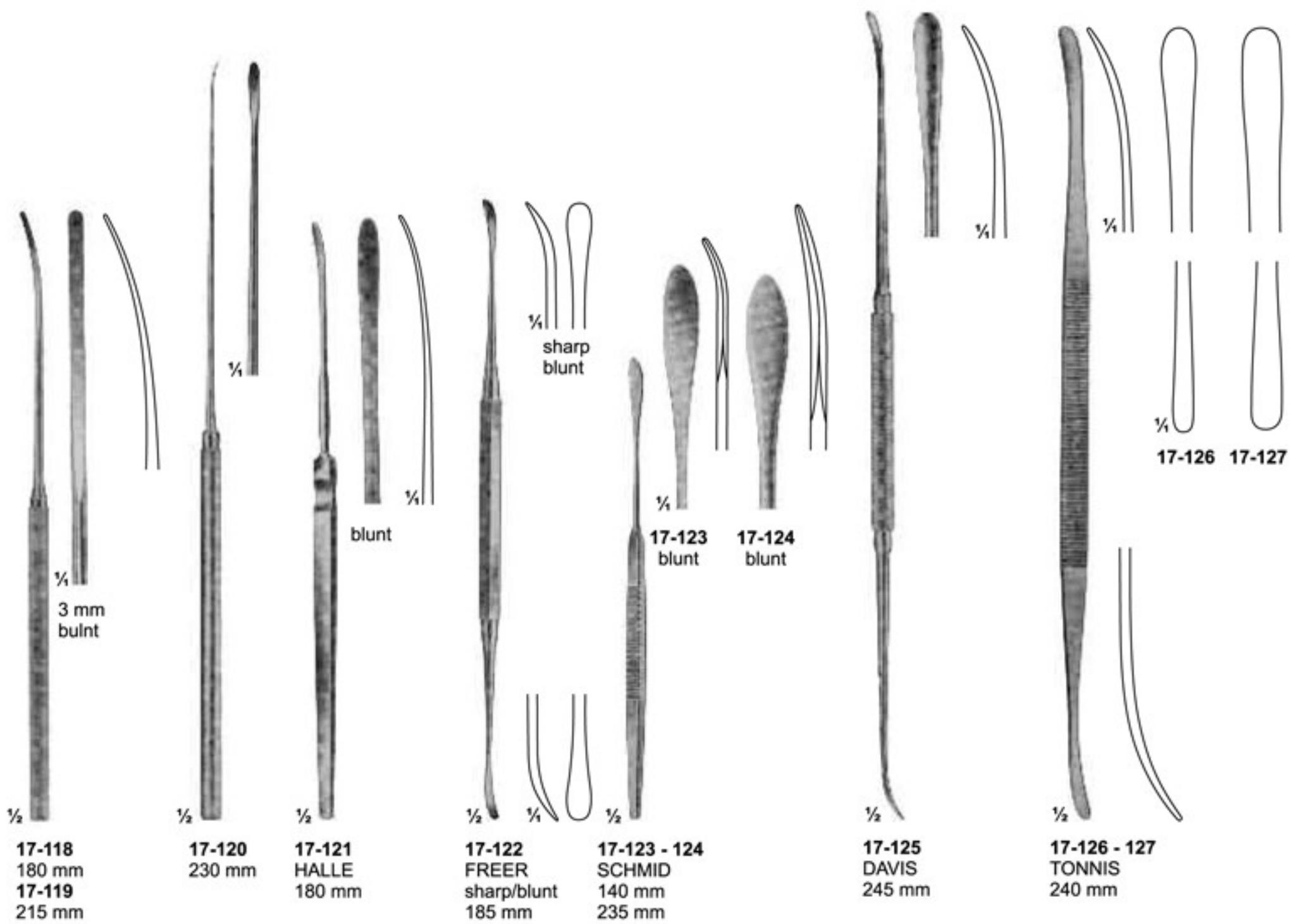

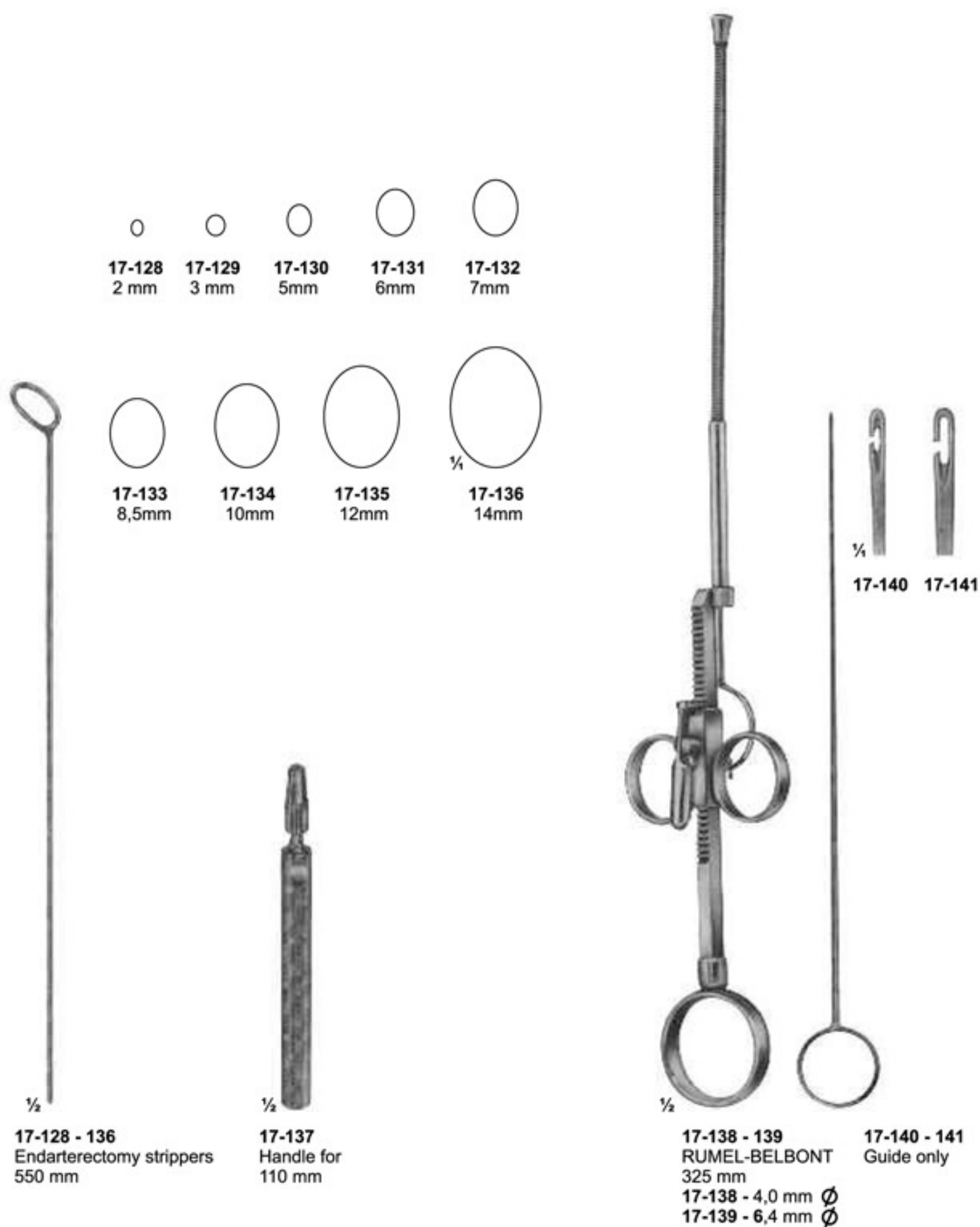

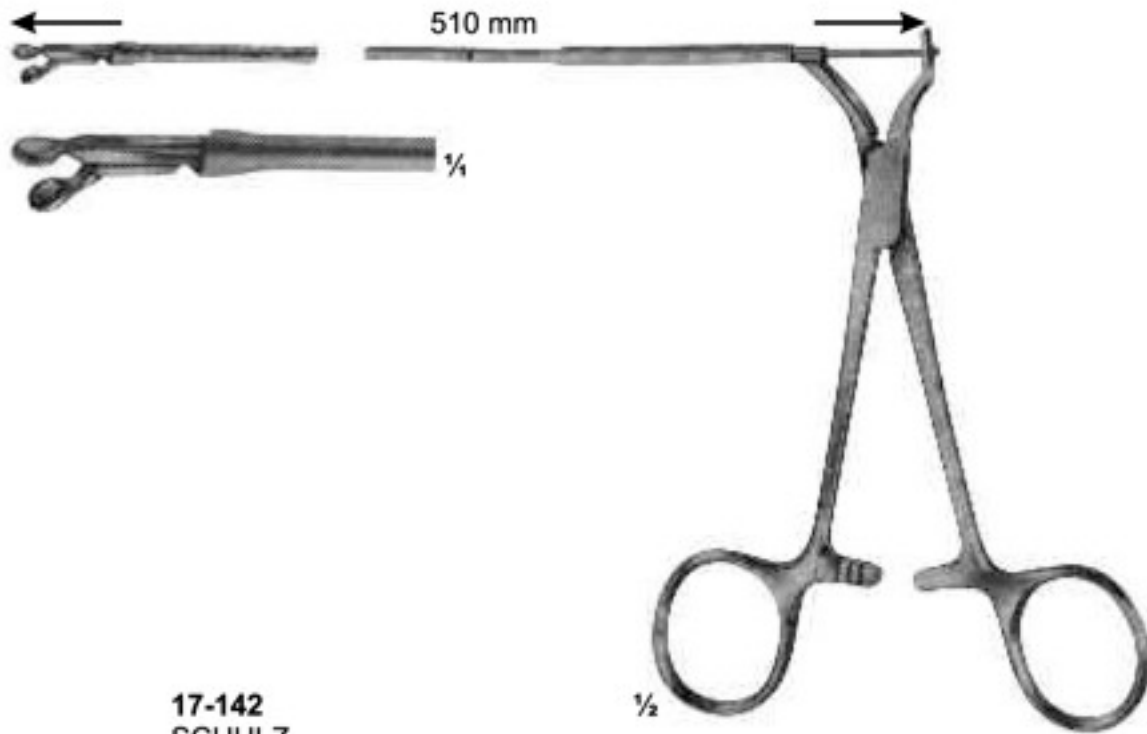

17-142 SCHULZ
 Biopotome, mit flexiblem Schaft, 510 mm lang, with round jaws 3 mm diam.
 Biopsy forceps, for biopsy from the right atrium through cava juglaris, prior to heart implantations.

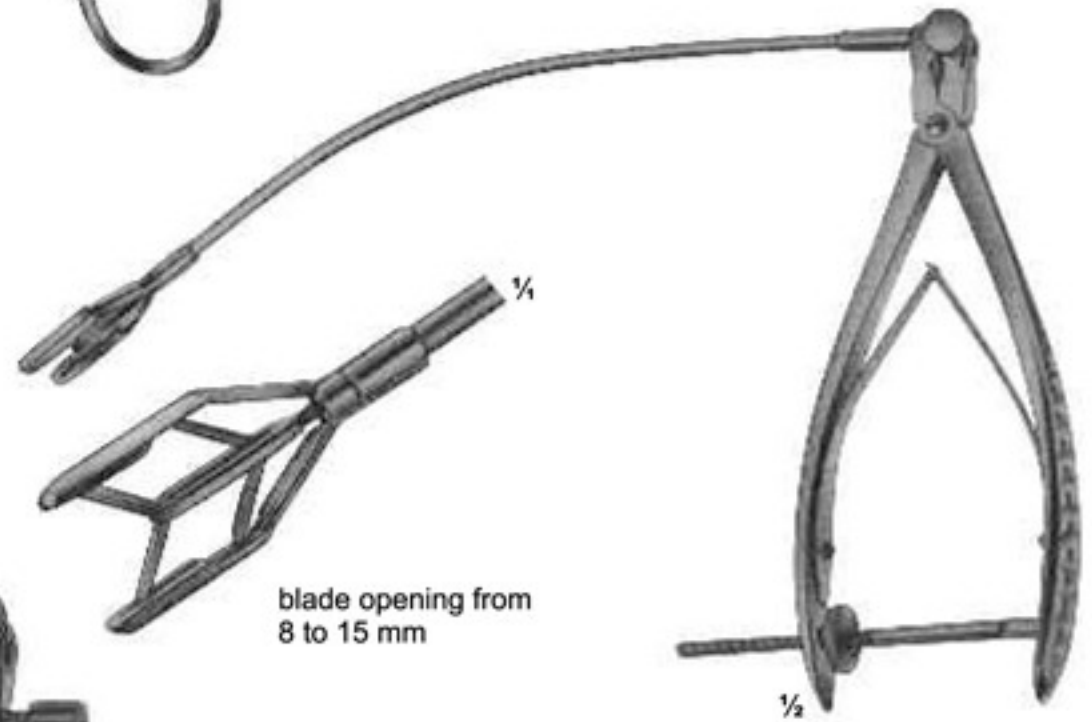

17-144 COOLEY
 Dilator for mitral valve for children

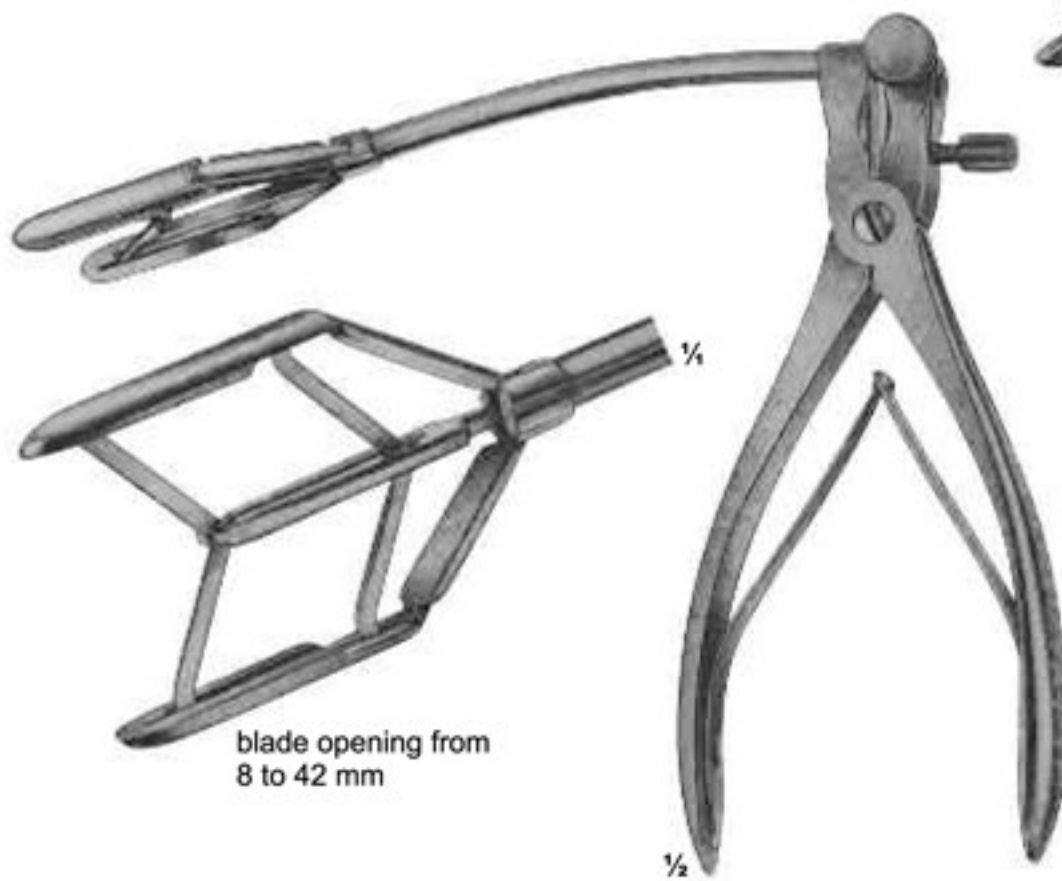

blade opening from 8 to 42 mm

17-143 TUBBS
 Dilator for mitral valve

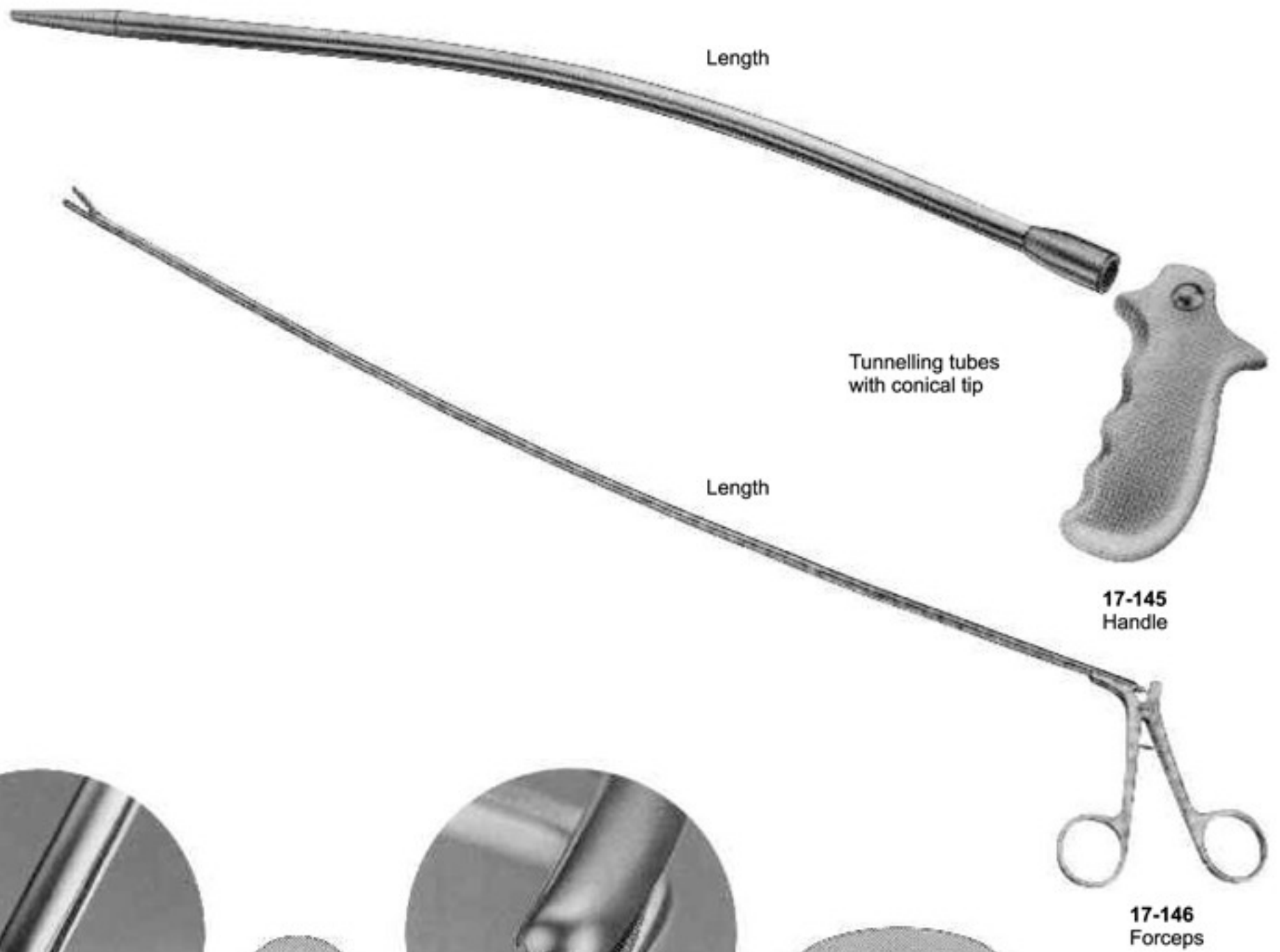

DE BAKEY
17-147
1 : 2 rows of teeth

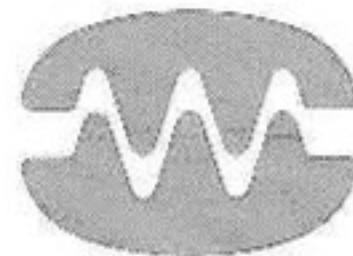

DE BAKEY
17-148
2 : 3 rows of teeth

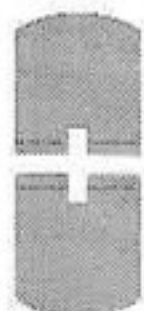
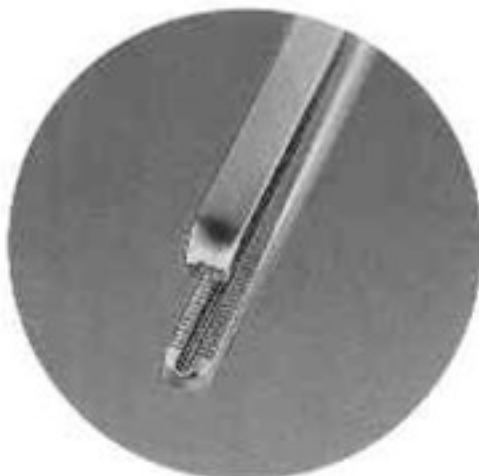

COOLEY
17-149
2 : 2 rows of teeth

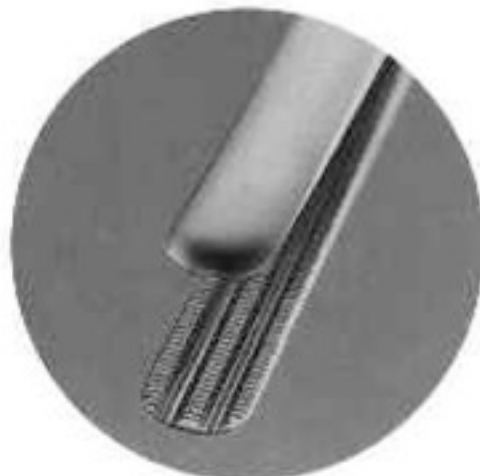

DARDIK
17-150
2 : 3 rows of teeth

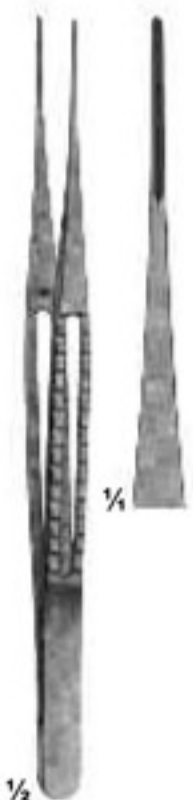

17-151
Width of jaws
1,5 mm
Length
150mm

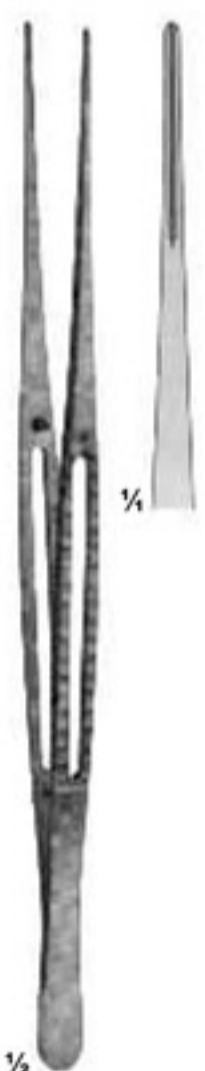

17-152
1,5 mm
200 mm



17-153
1,5 mm
240 mm



17-154
1,5 mm
300 mm

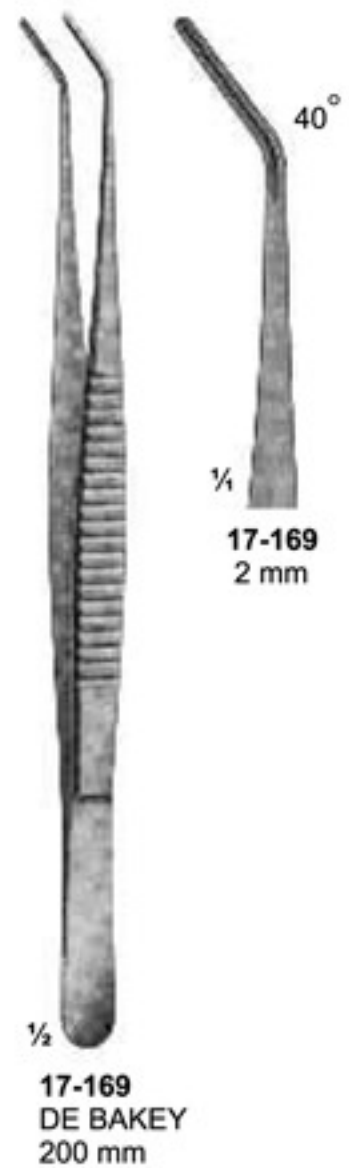
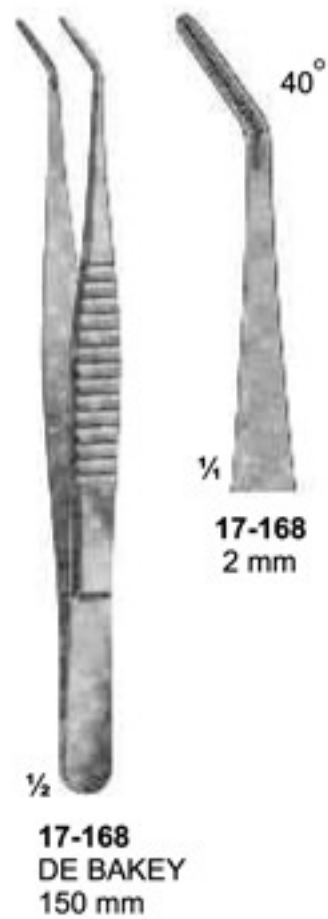
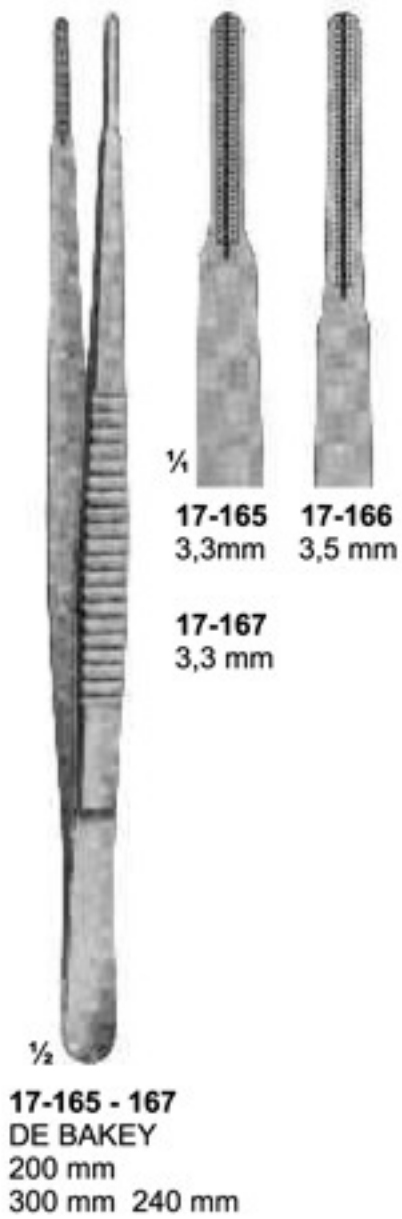
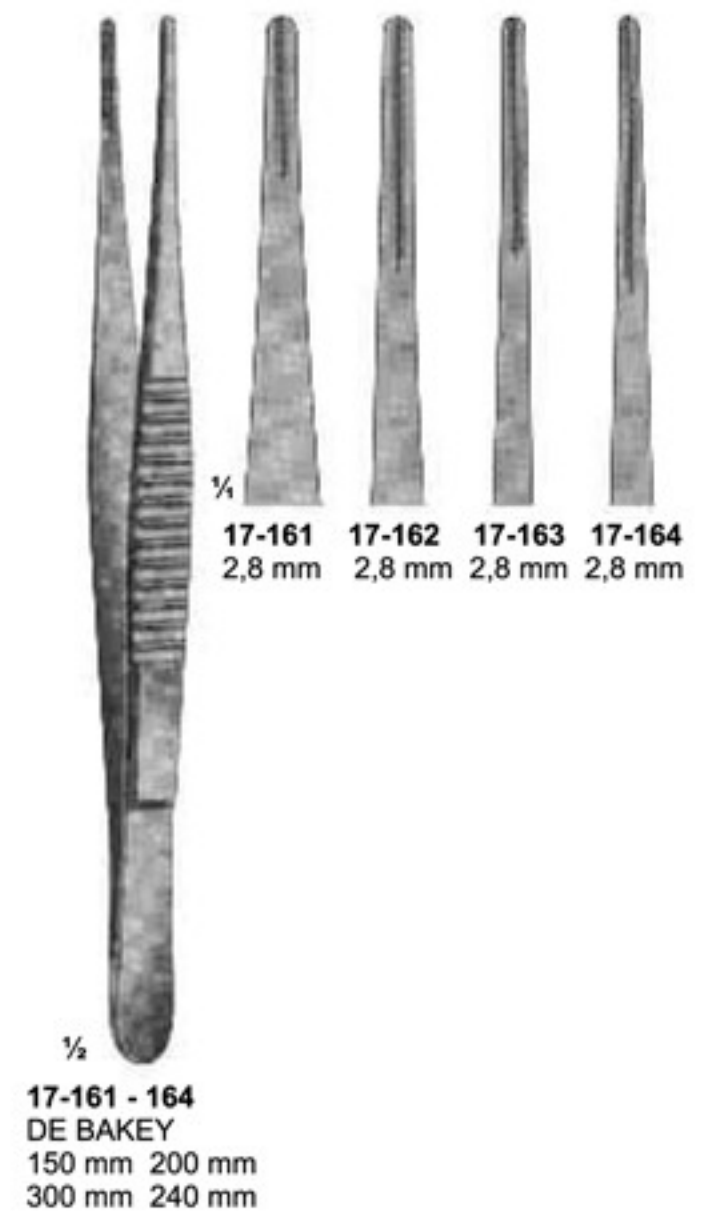
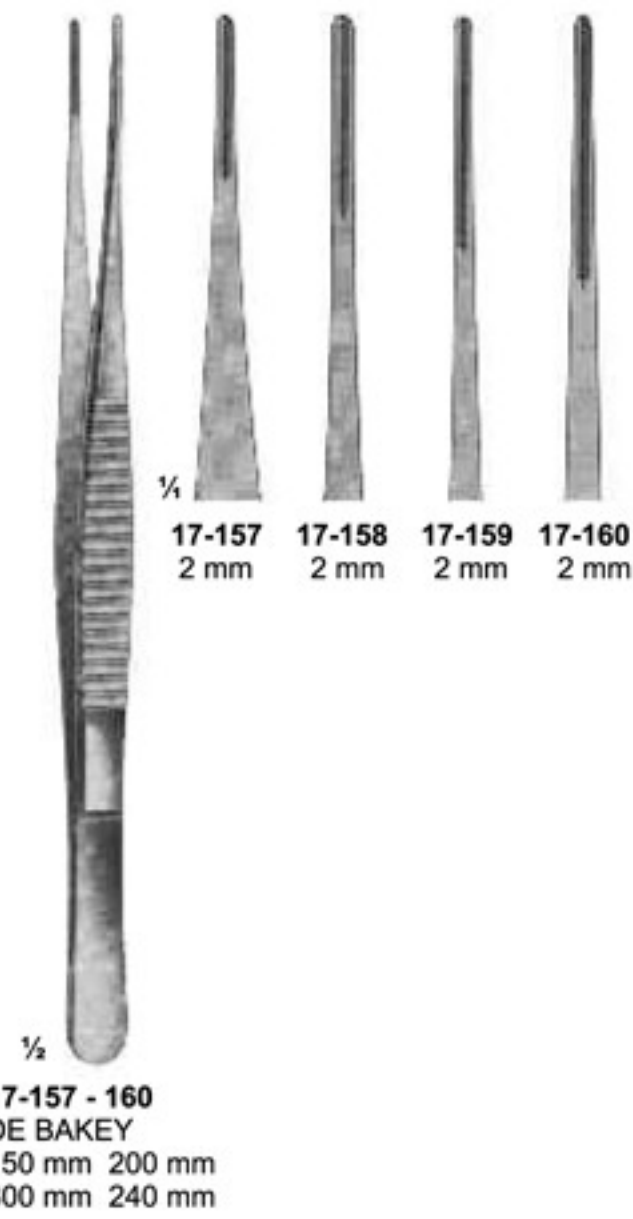
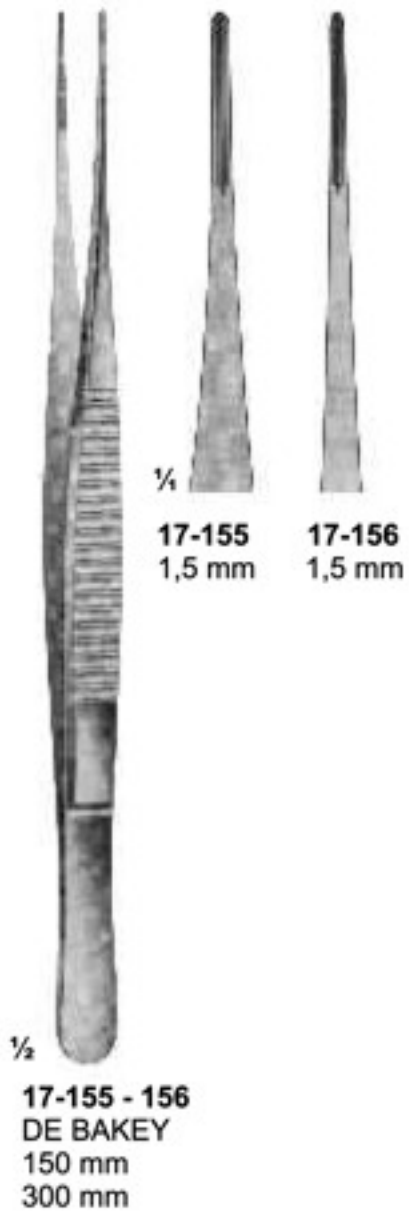

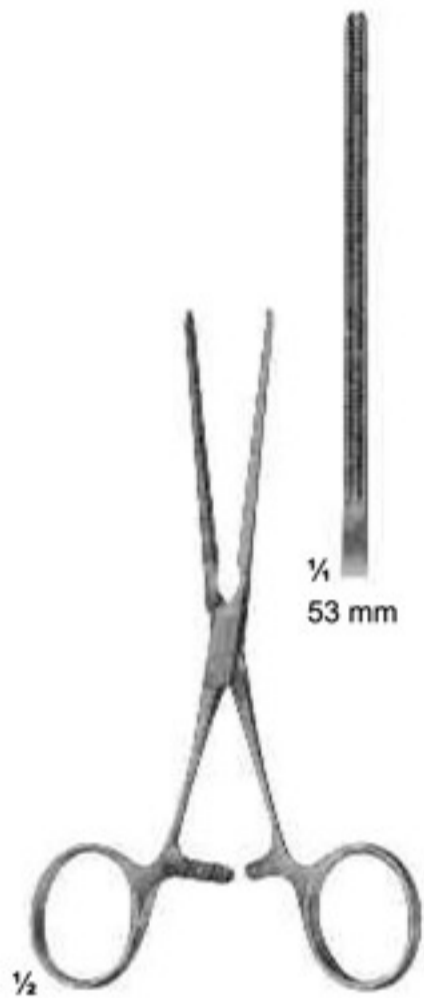

17-170
DE-BAKEY
gerade straight
130 mm

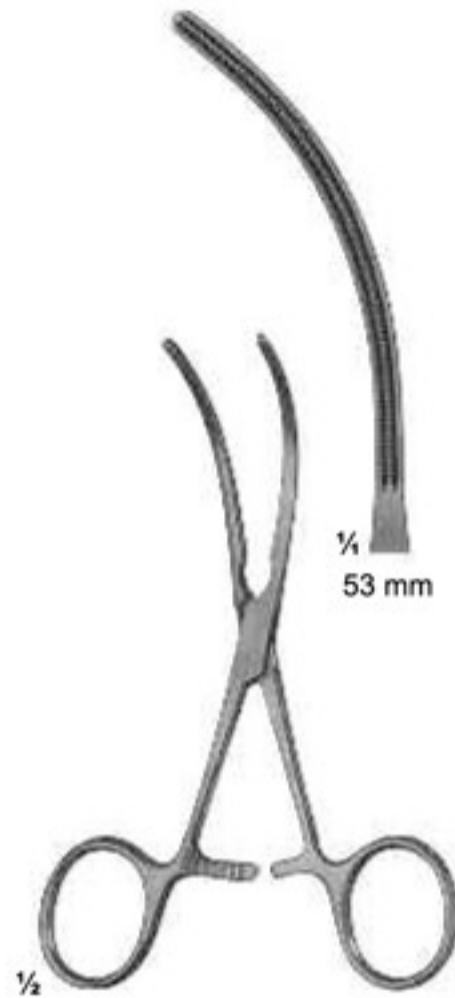

17-171
DE-BAKEY
Maul gebogen
curved jaws
125 mm

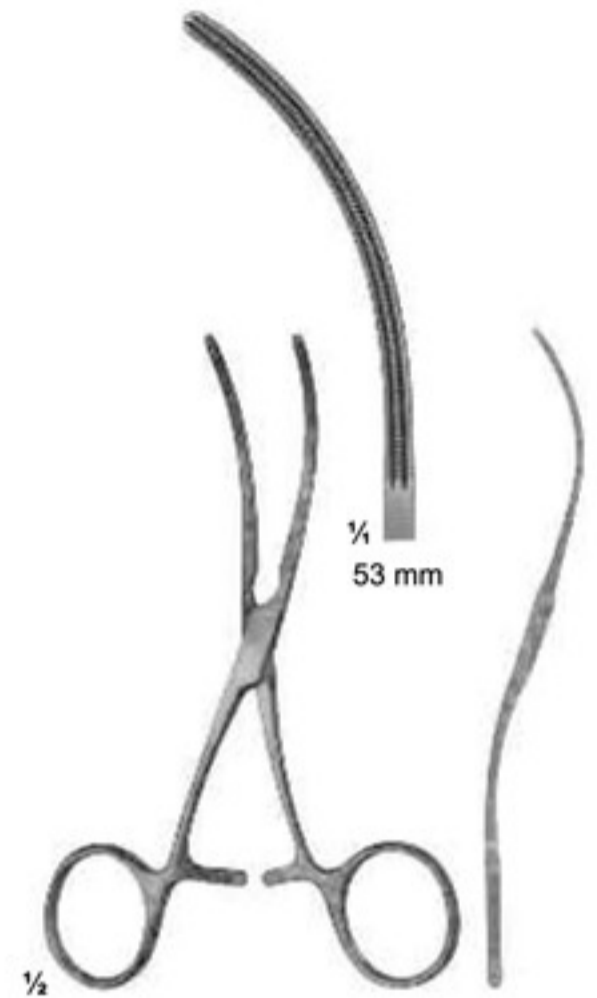

17-172
DE-BAKEY
S-shaped curved
125 mm

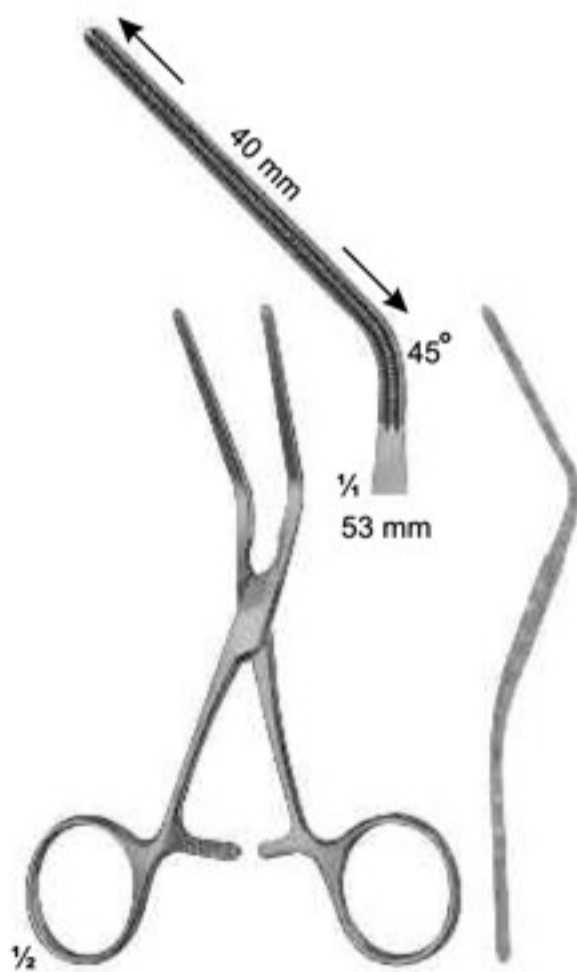

17-173
DE-BAKEY
45° winklig gebogen
angled 45°
125 mm

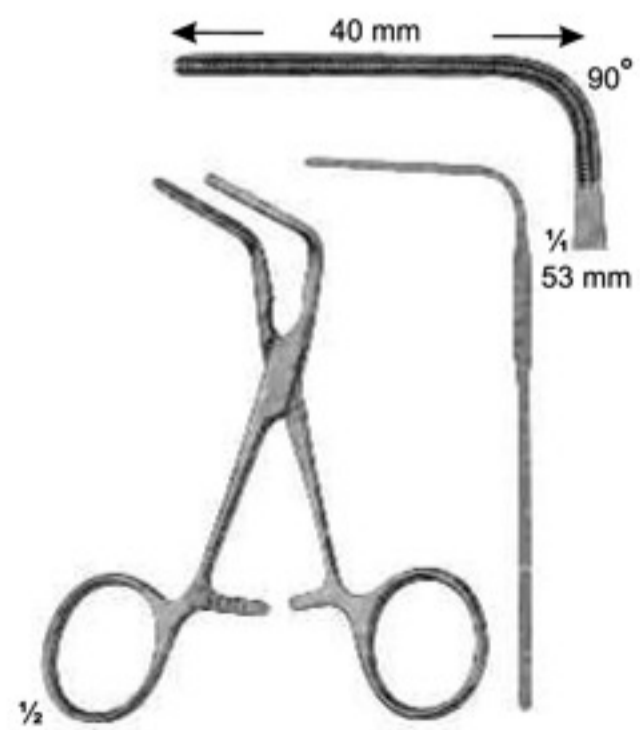

17-174
DE-BAKEY
90° winklig gebogen
angled 90°
105 mm

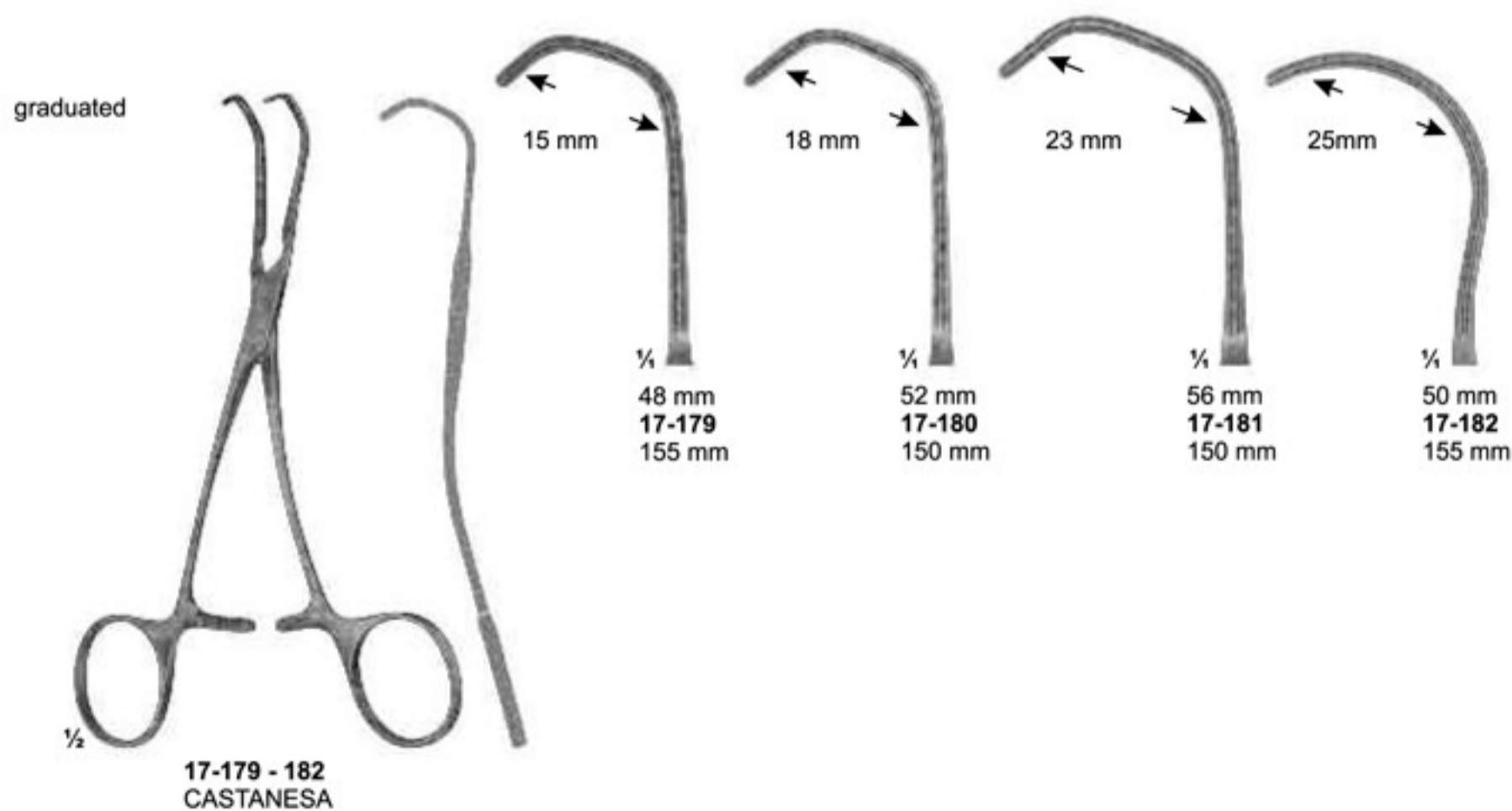
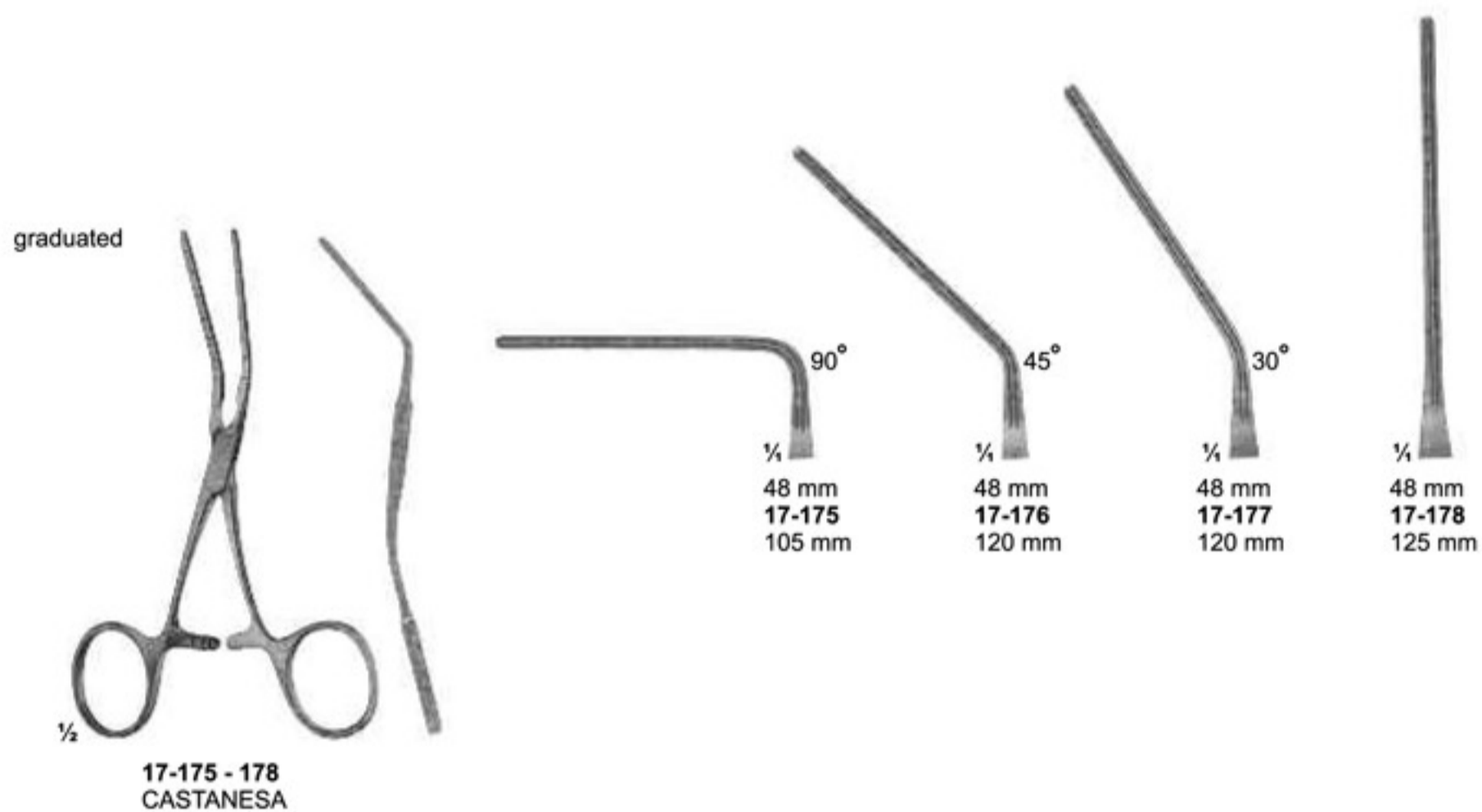

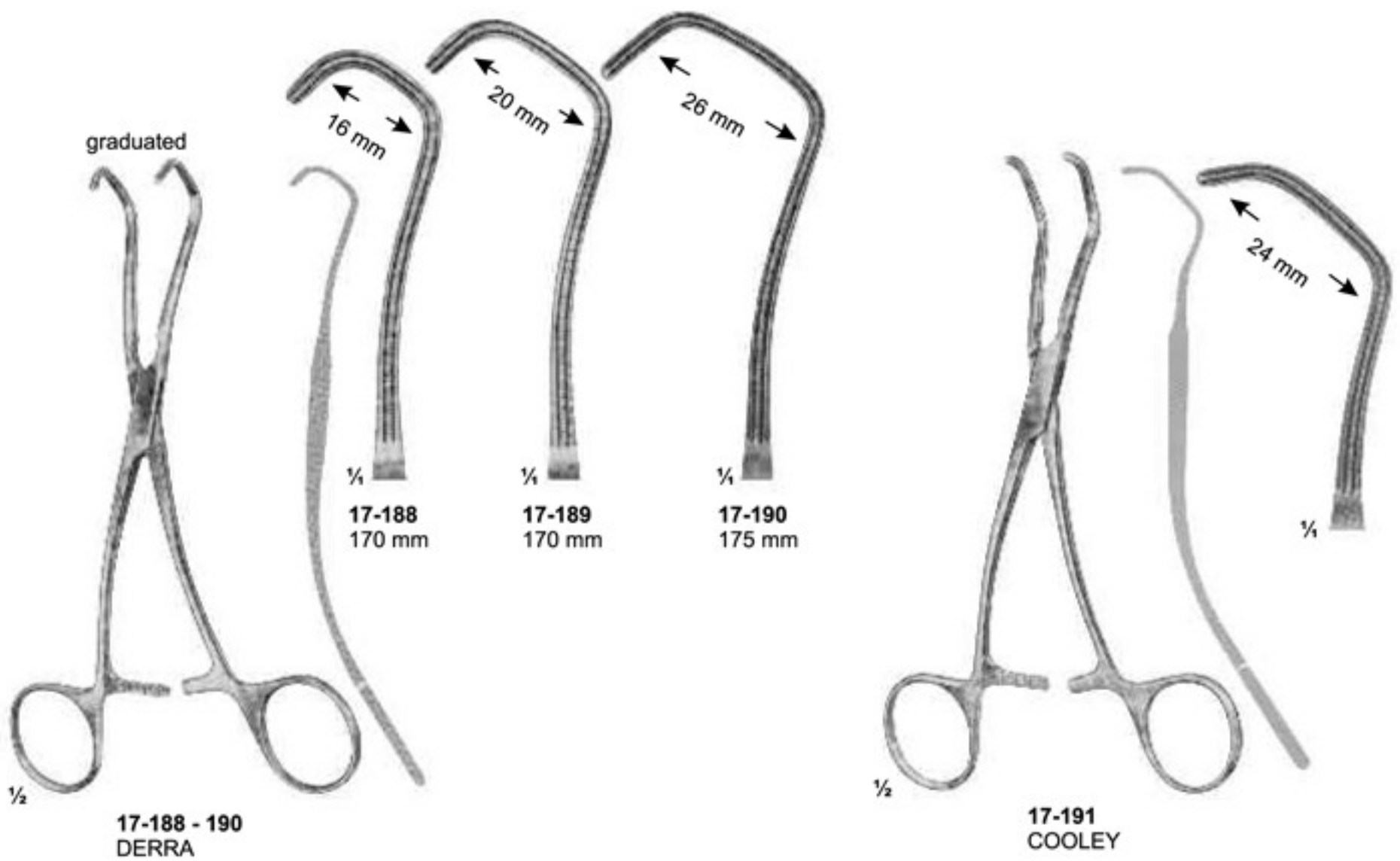
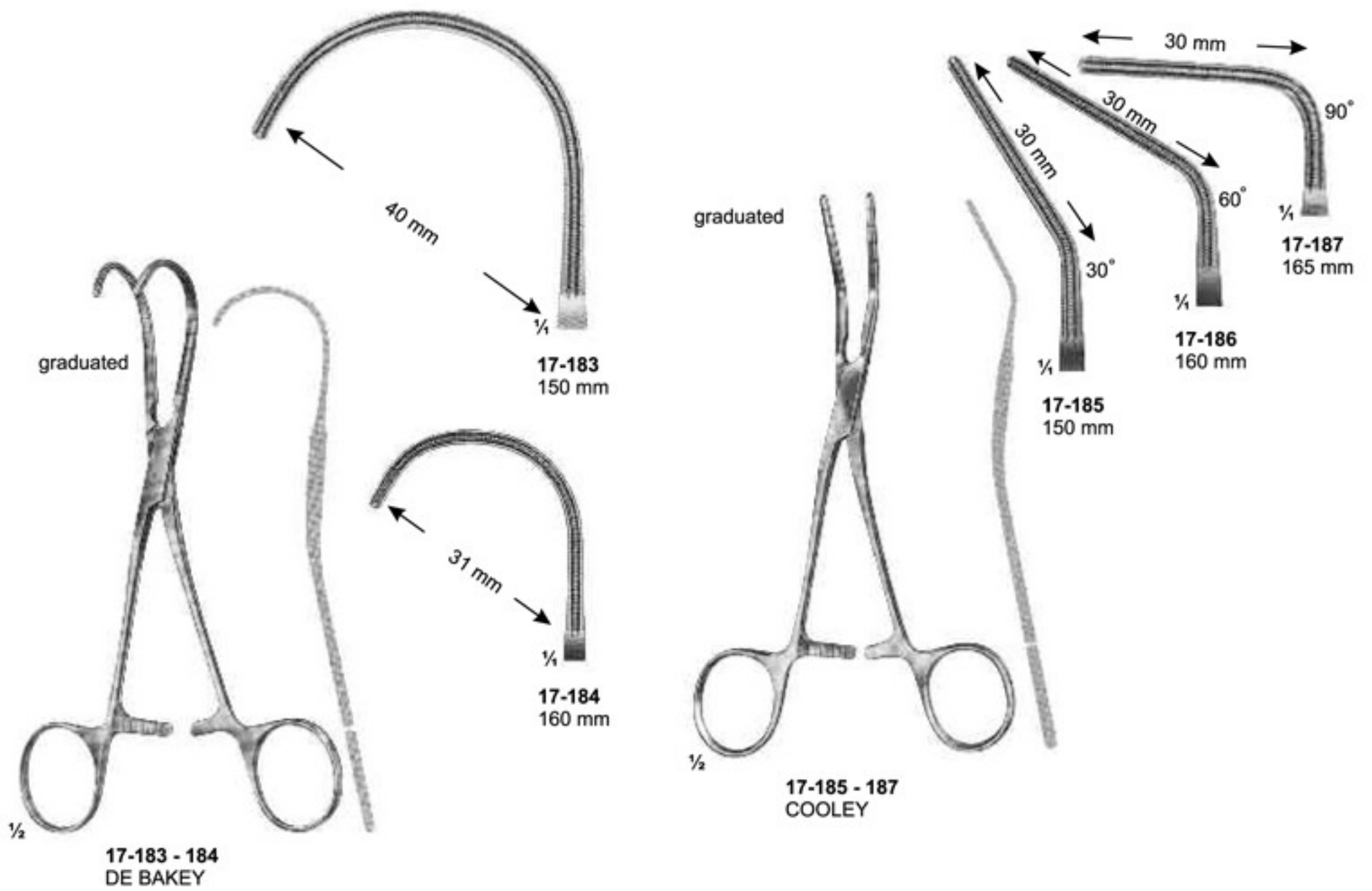

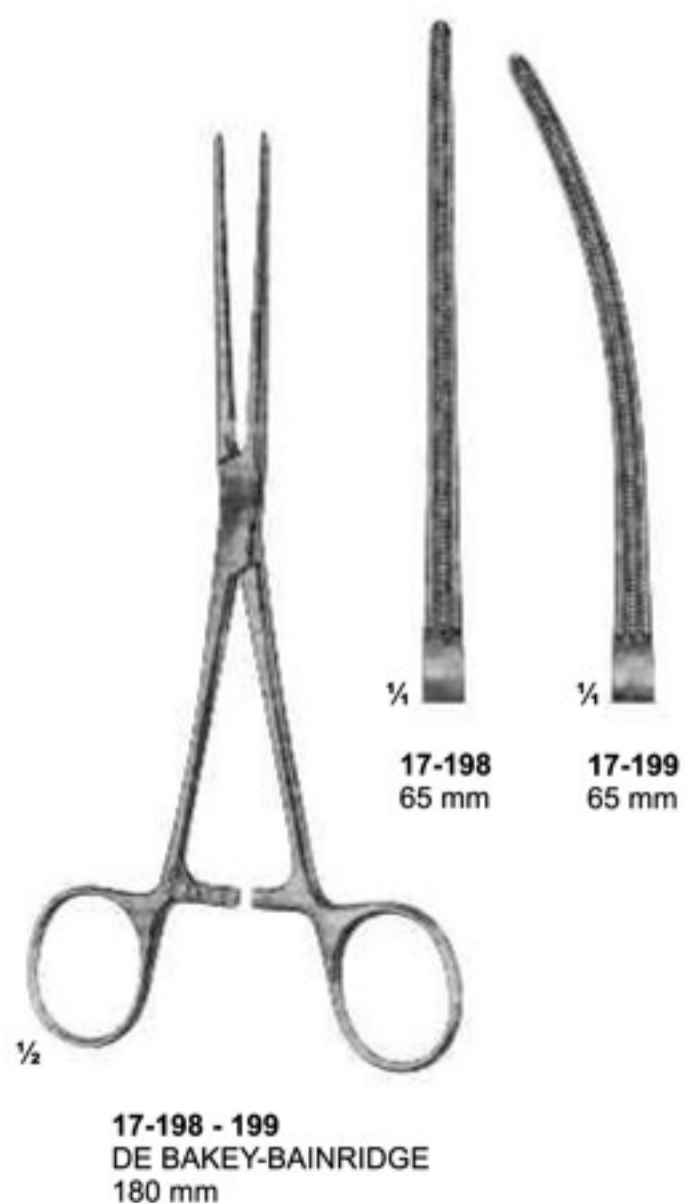
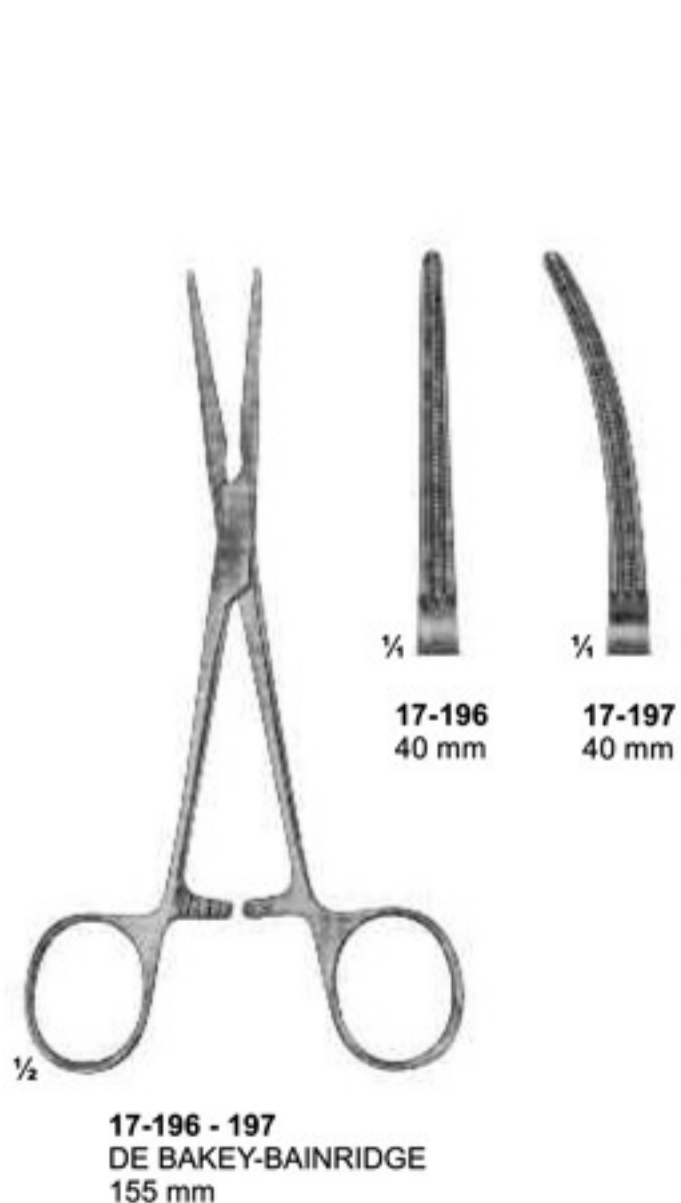
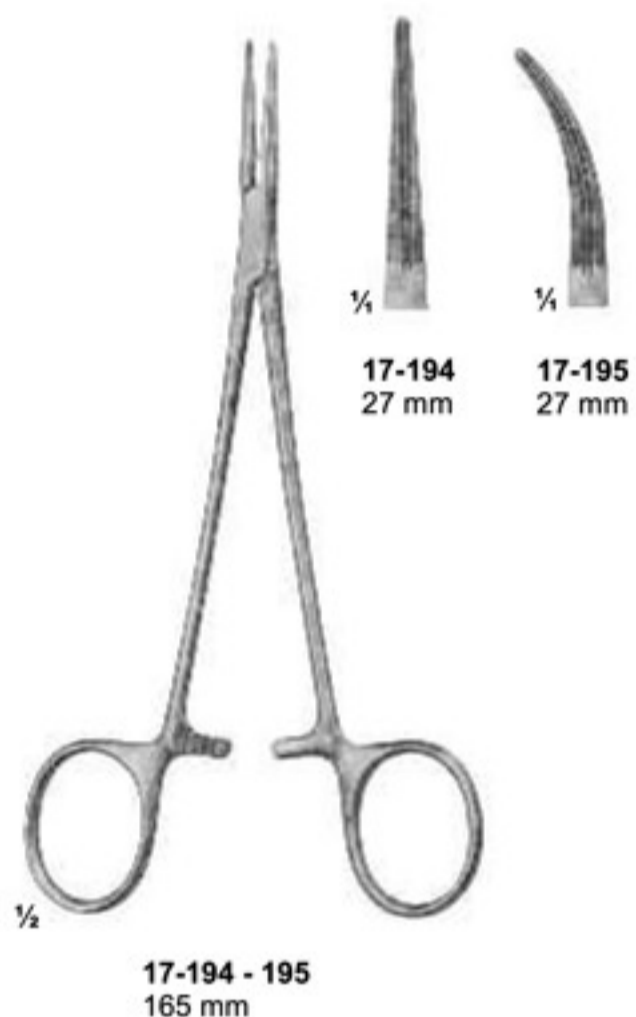
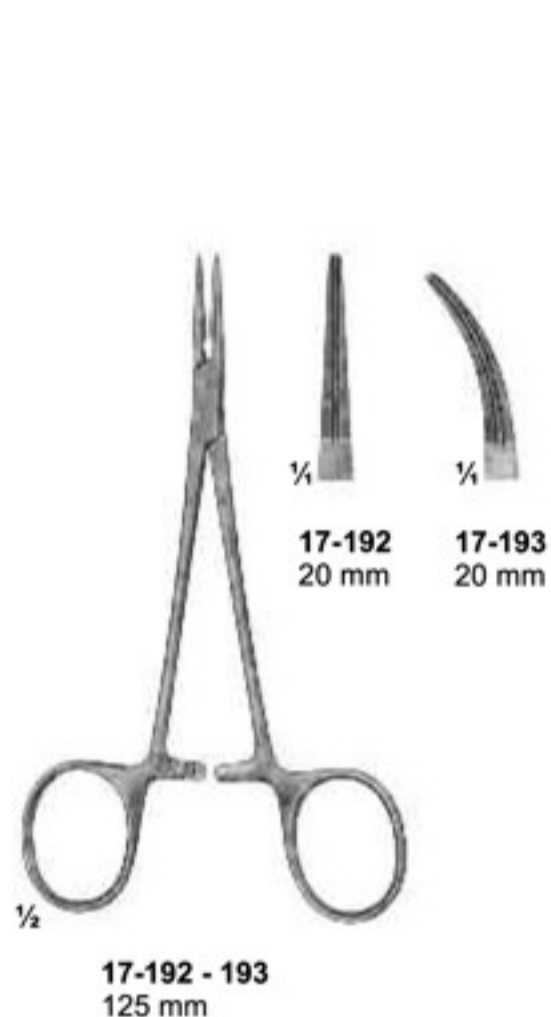

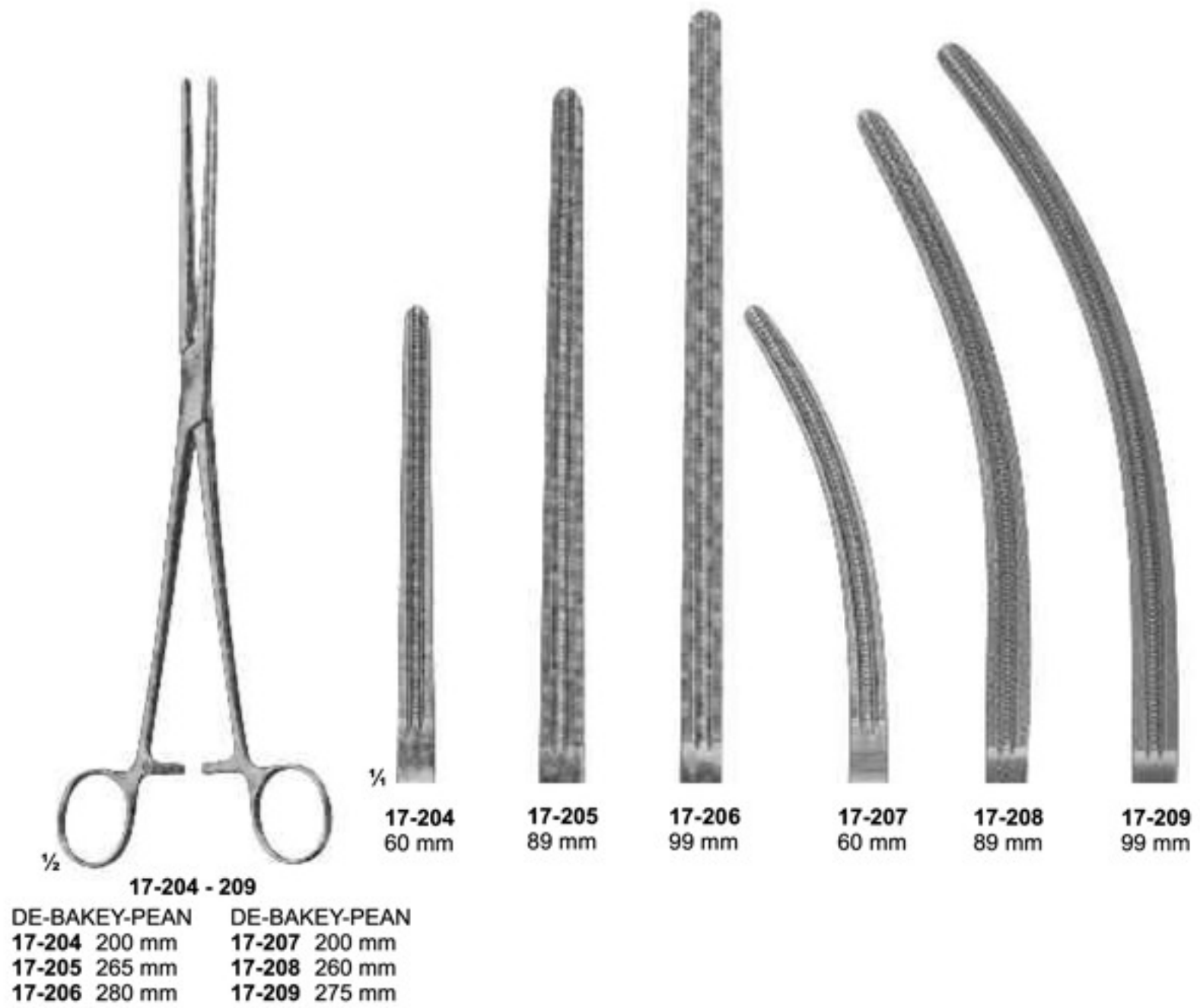
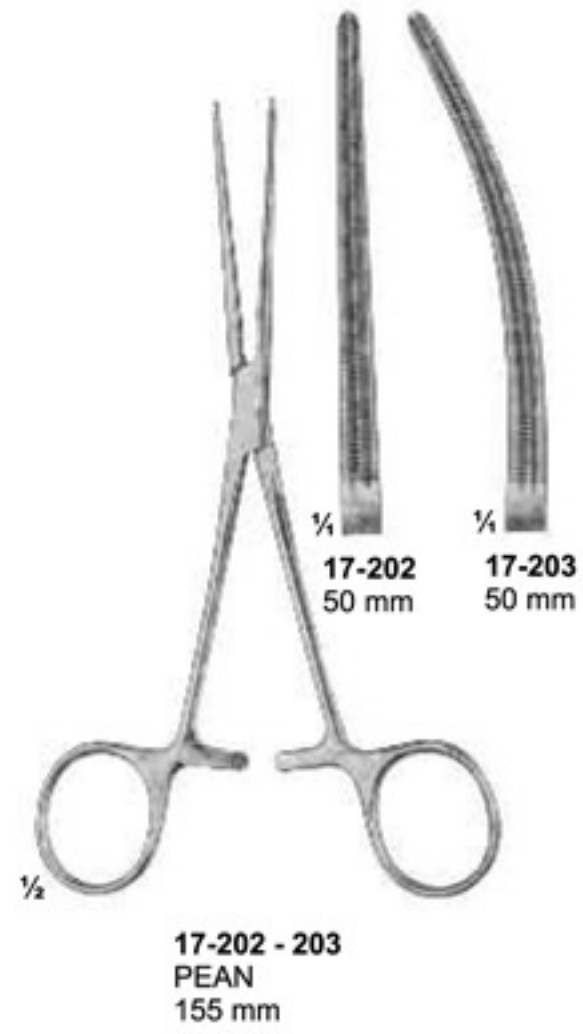

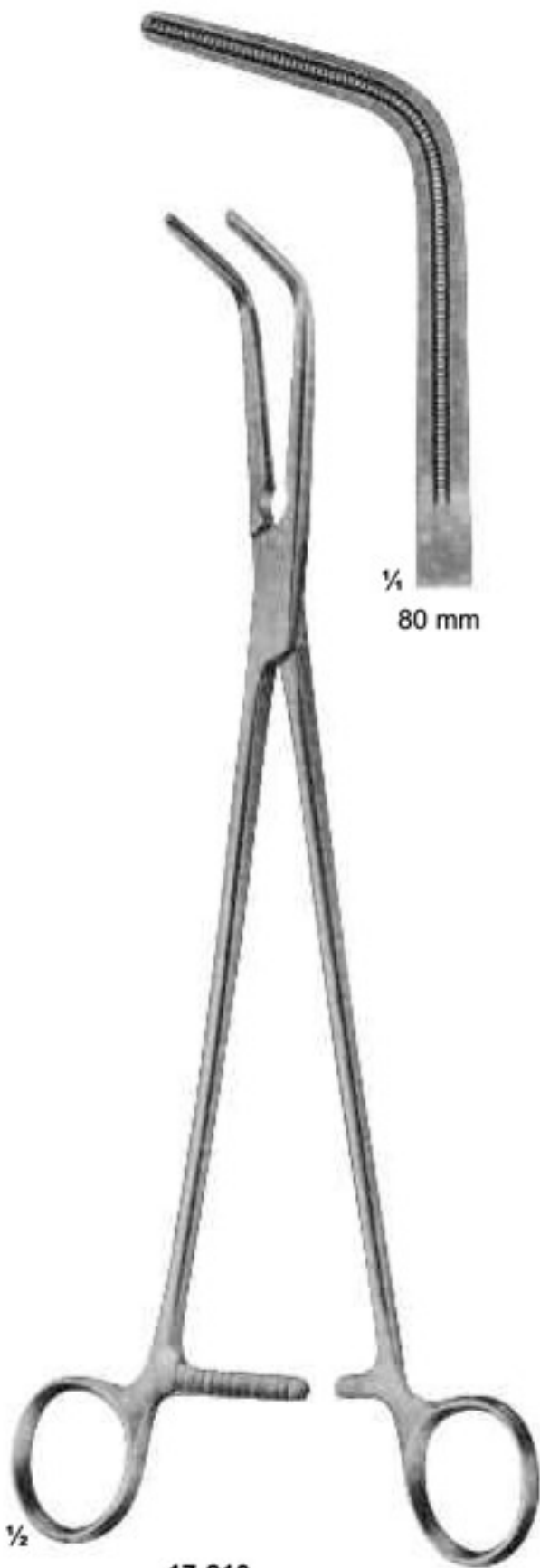

17-210
DE-BAKEY-MIXTER
285 mm

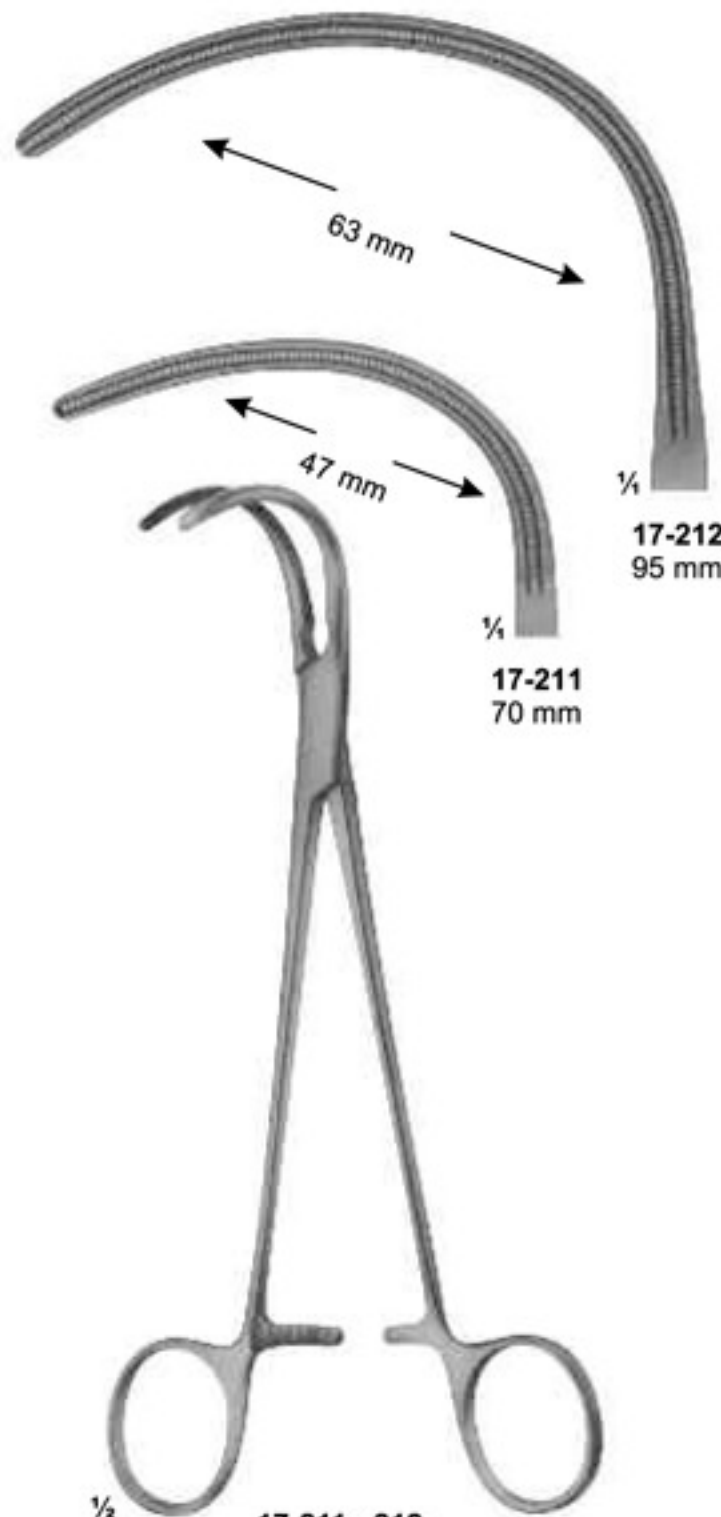

17-211 - 212
GLOVER
245 mm

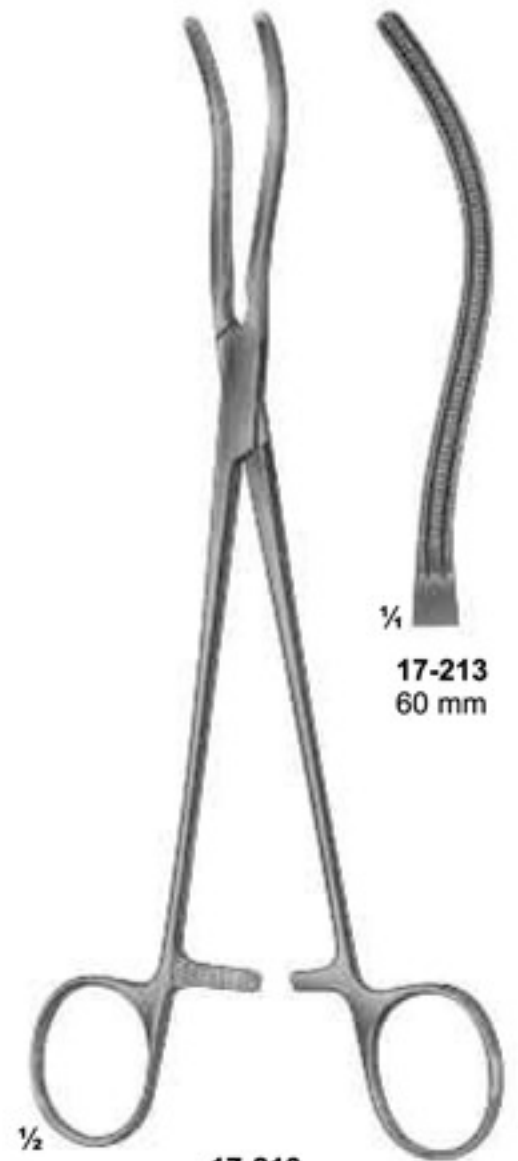

17-213
GLOVER
220 mm

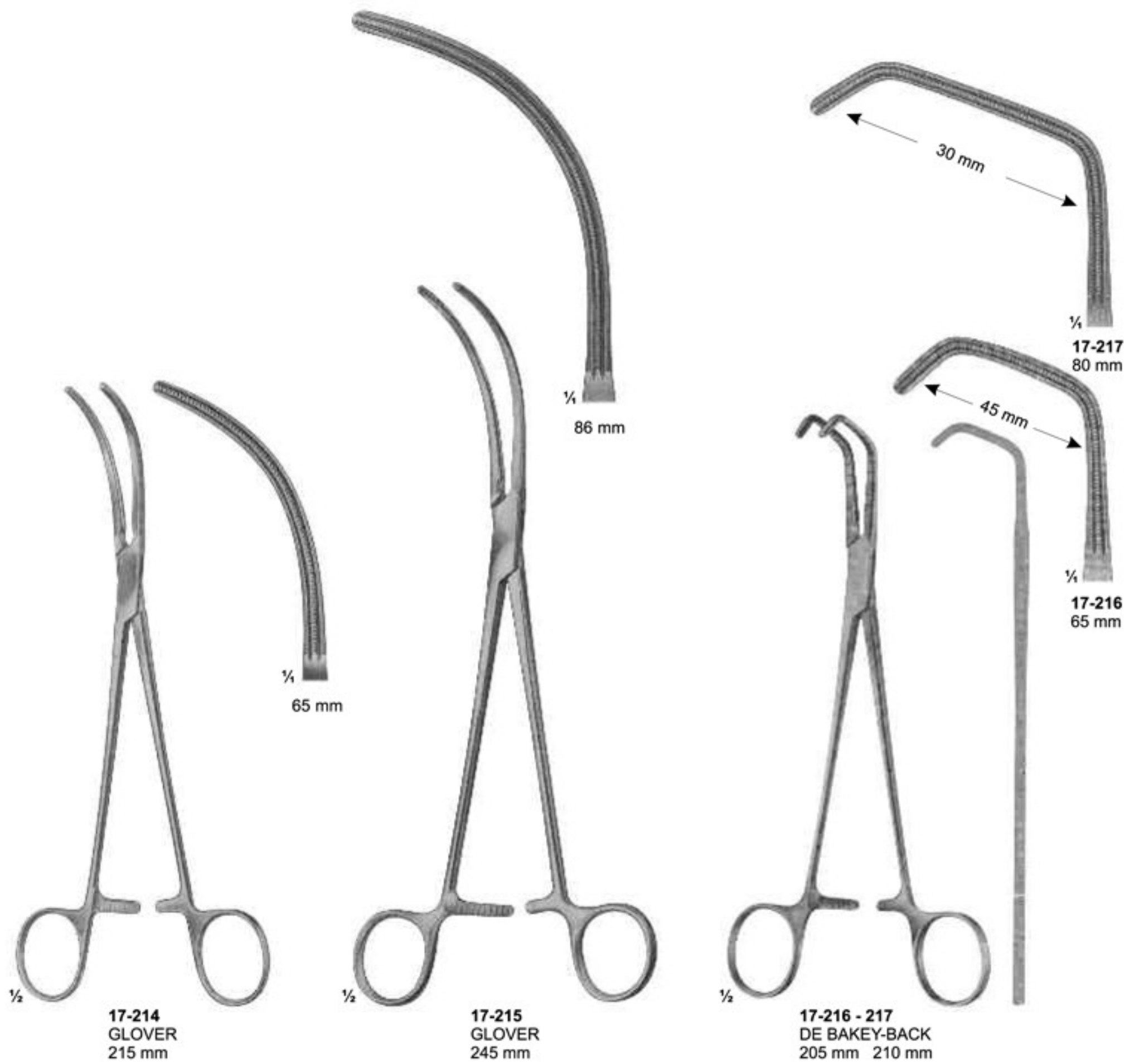

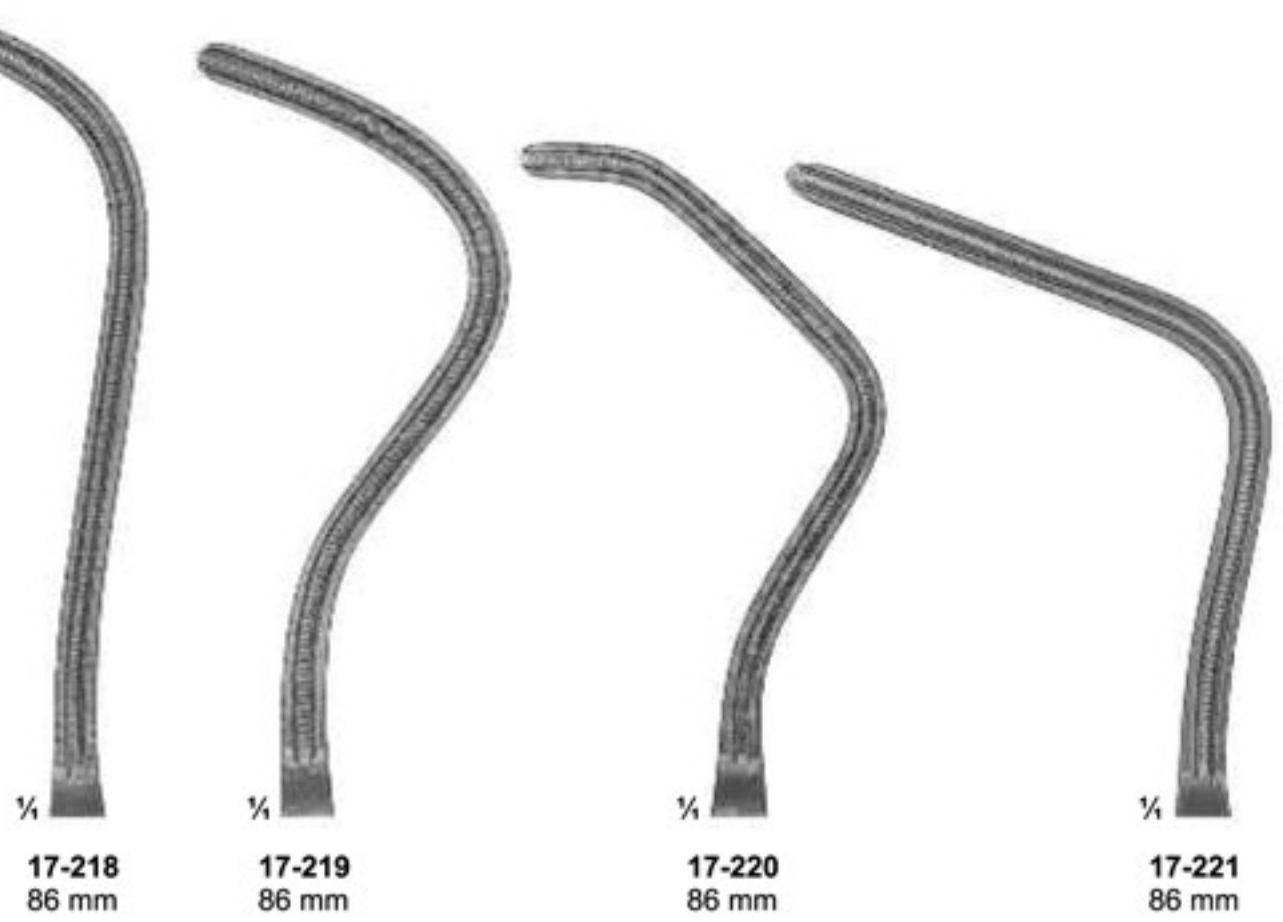
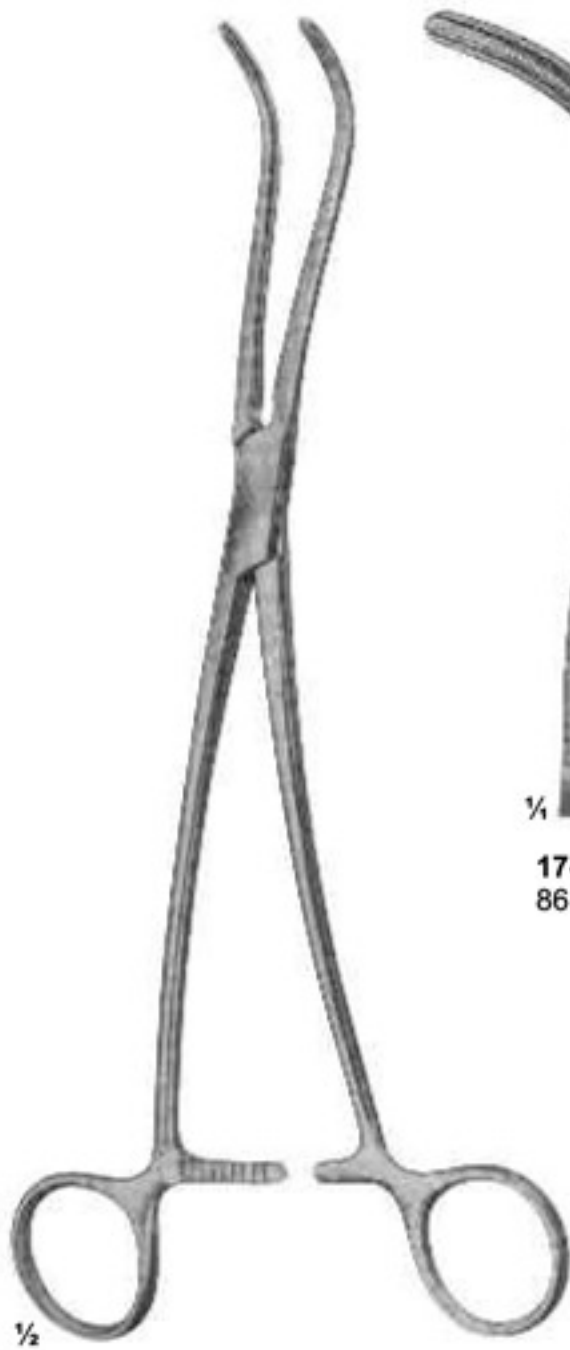

17-218 - 221
DE BAKEY-HARKEN
 17-218 - 255 mm
 17-219 - 245 mm
 17-220 - 245 mm
 17-221 - 245 mm

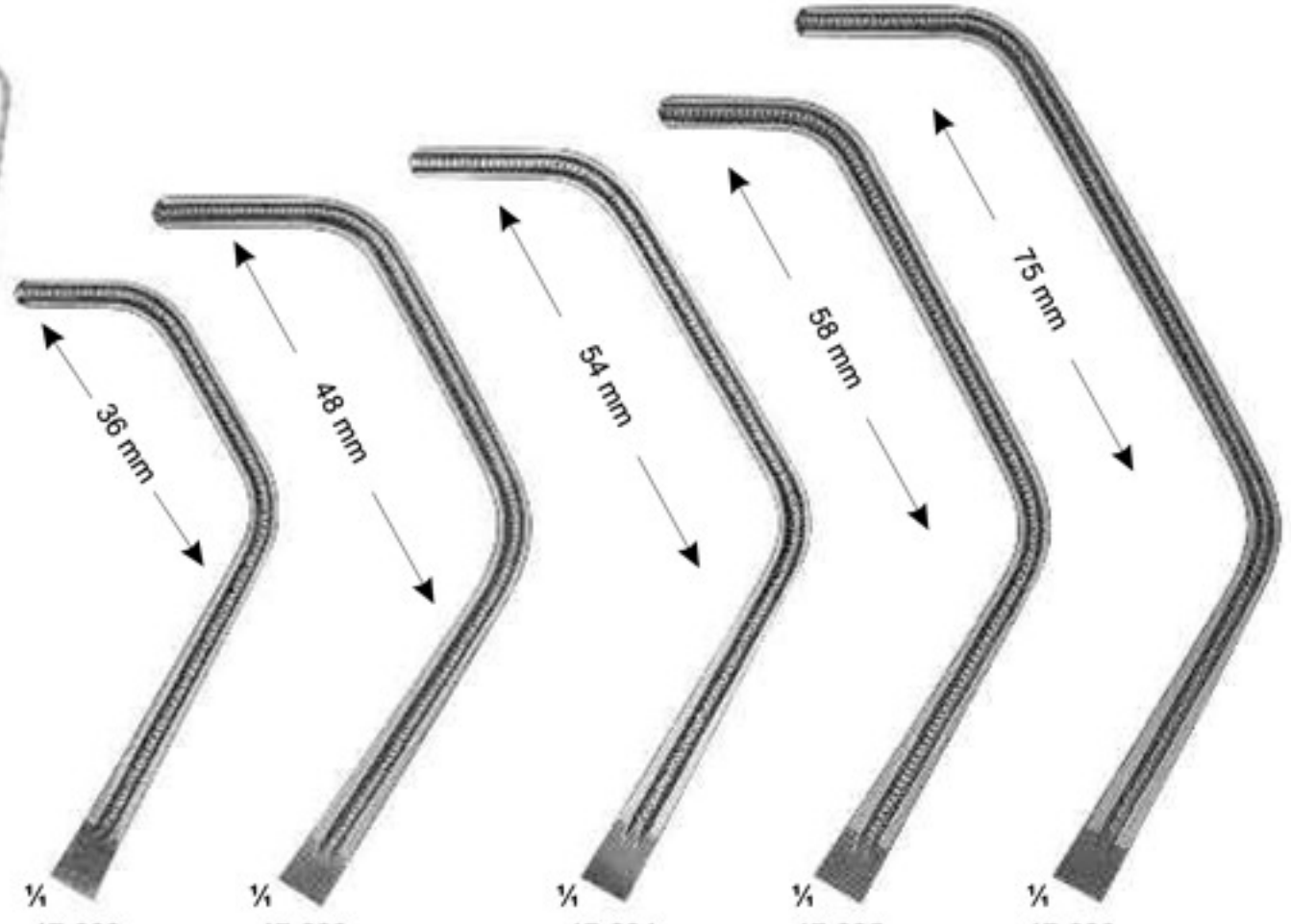

17-222 - 226
DE BAKEY

Total Length:	220 mm	256 mm	270 mm	270 mm	280 mm
Length of jaws:	85 mm	95 mm	99 mm	103 mm	119 mm

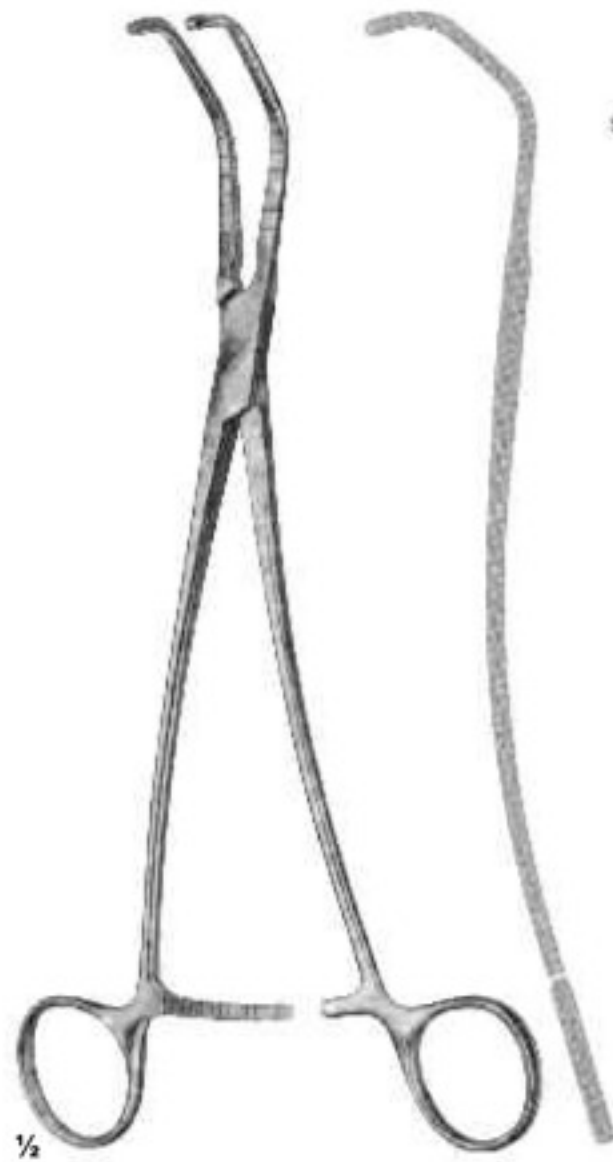

1/2

17-227 - 229
DE BAKEY-SATINSKY
235 mm, 240 mm, 245 mm

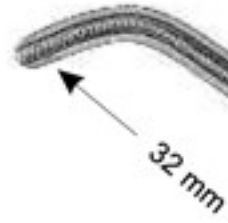

1/4

17-227
68 mm

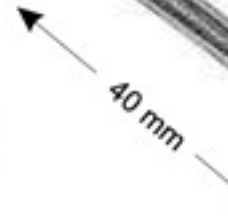

1/4

17-228
76 mm

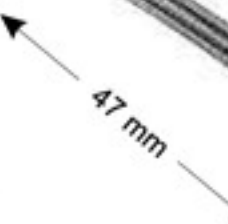

1/4

17-229
84 mm

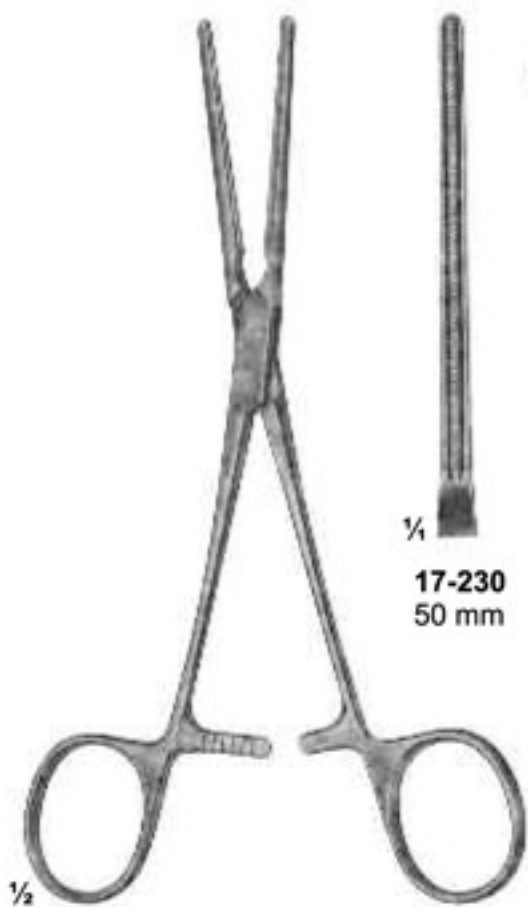

1/2

17-230 - 231
DE BAKEY
170 mm, 165 mm

1/4

17-230
50 mm

1/4

17-231
50 mm



1/2

17-232
DE BAKEY
165 mm

1/4

50 mm

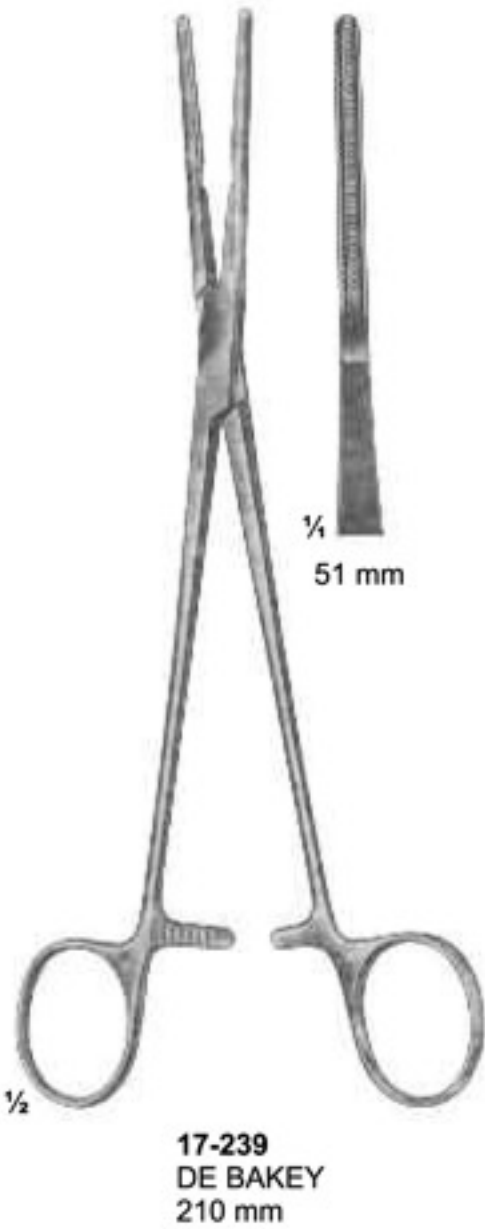
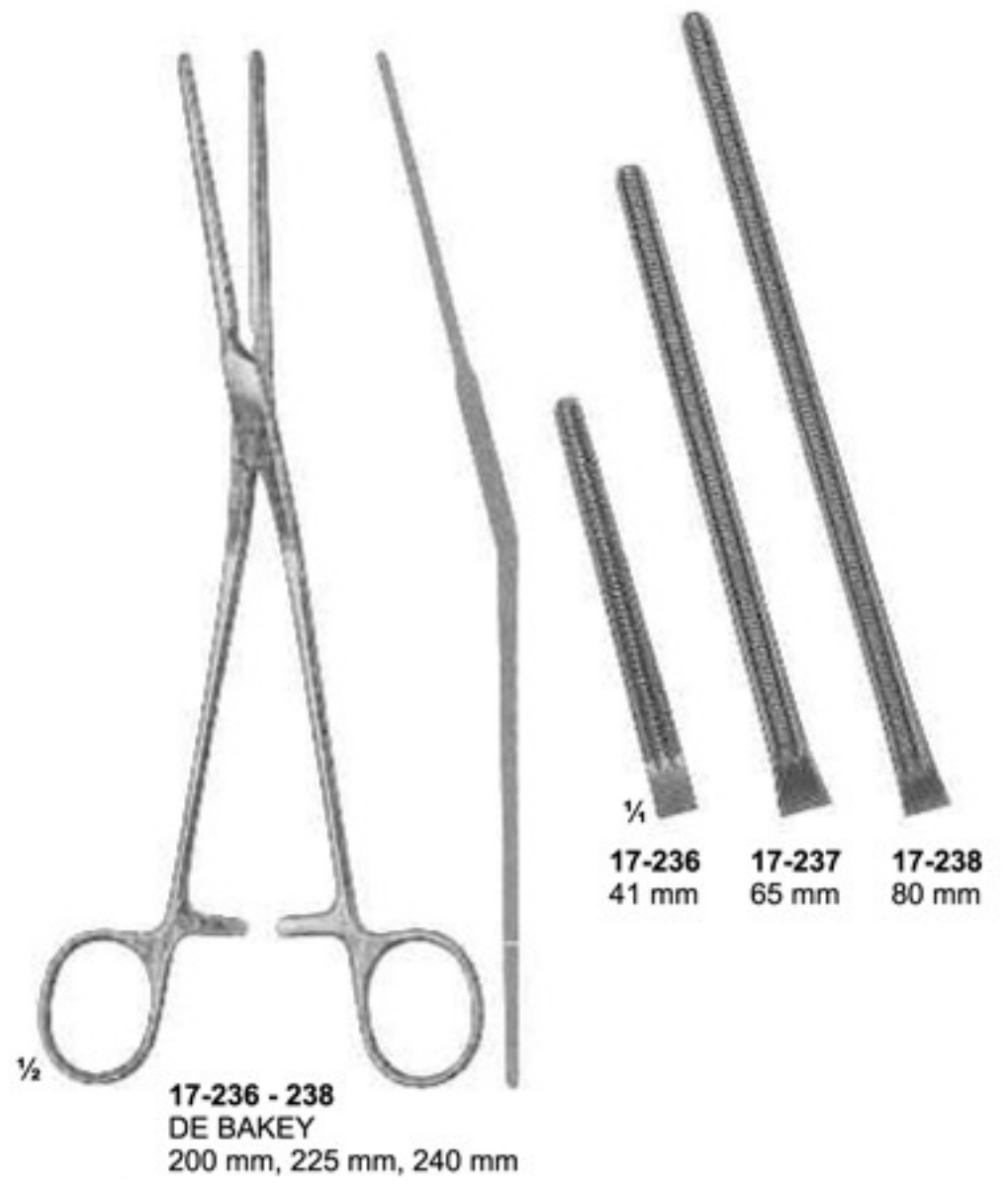
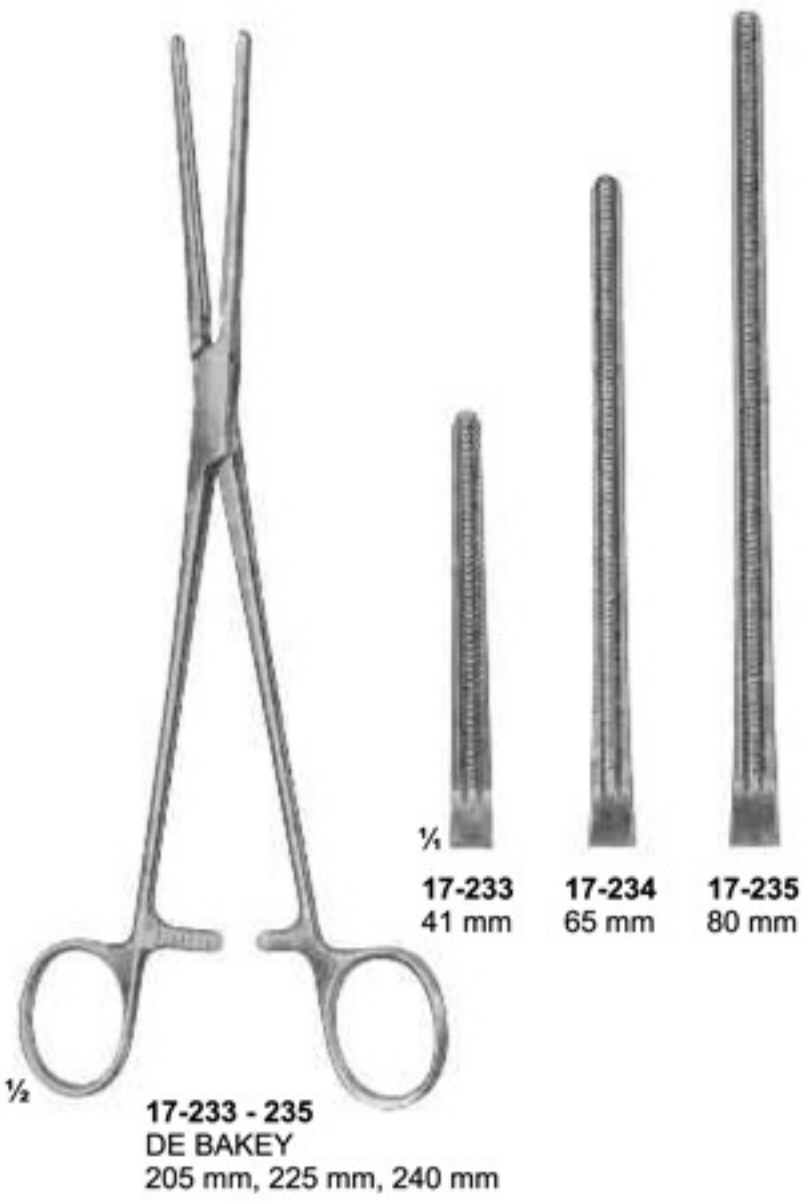

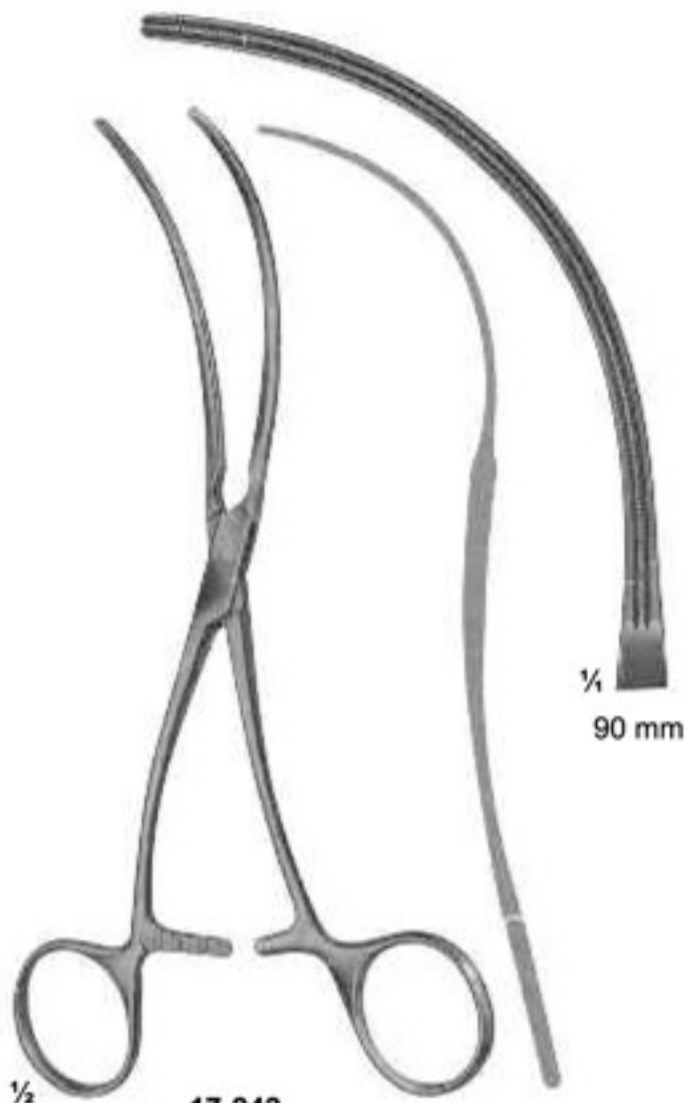

17-242
DE BAKEY
190 mm

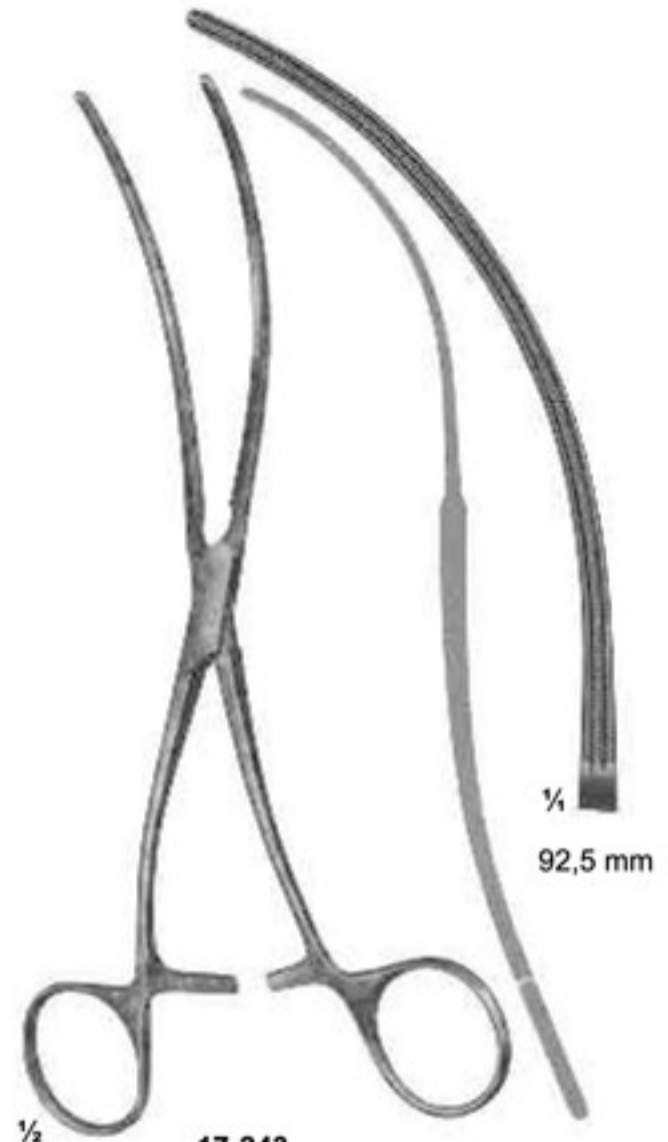

17-243
DE BAKEY
200 mm

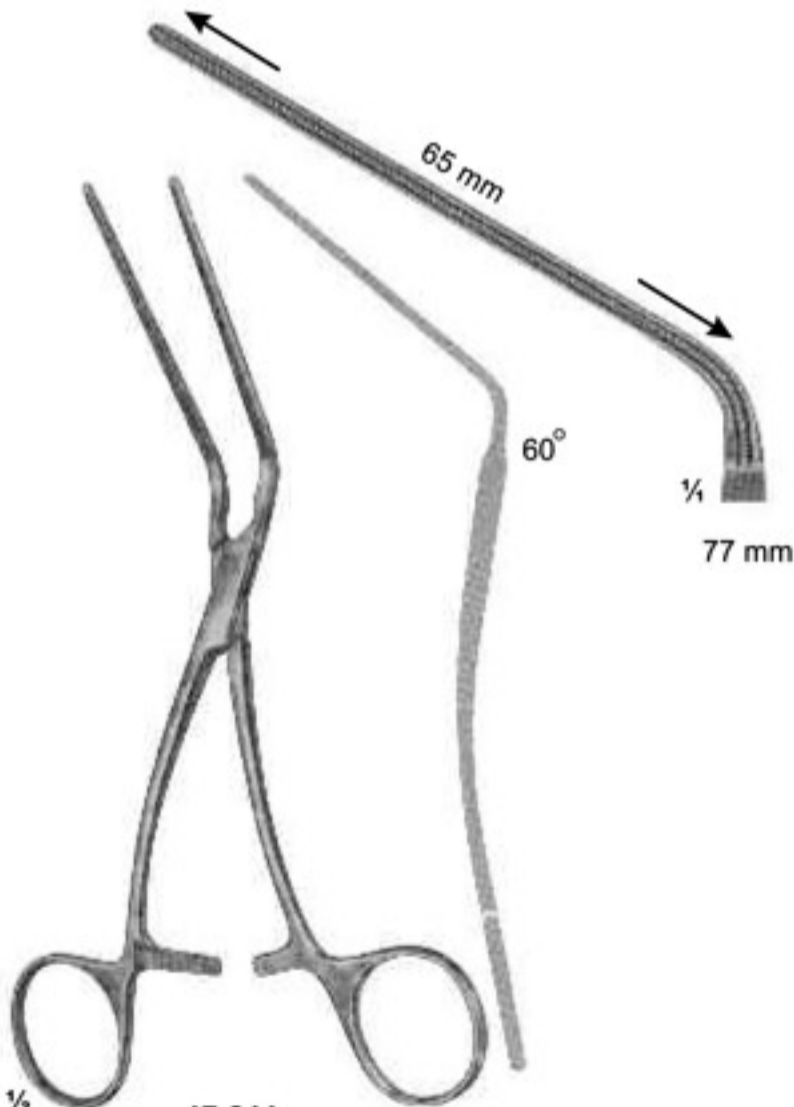

17-244
DE BAKEY
180 mm

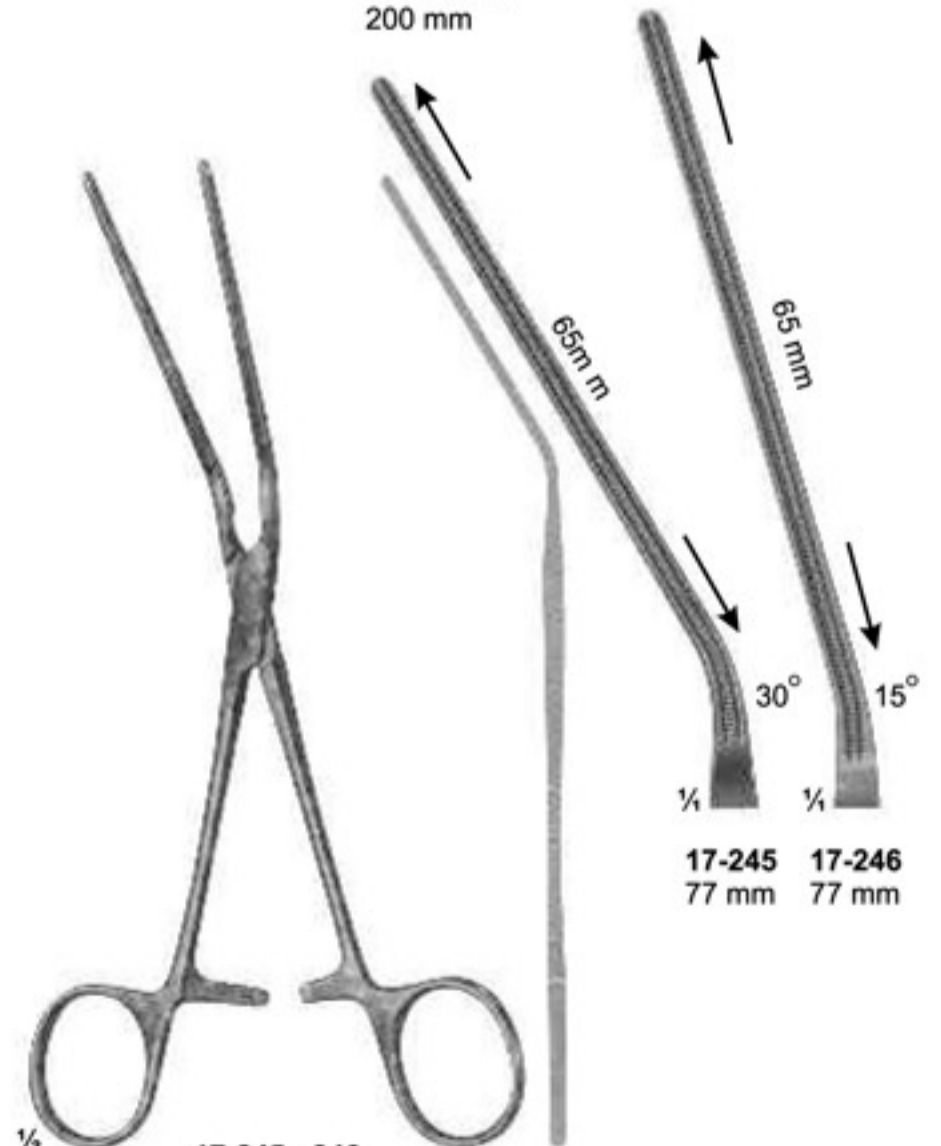

17-245 - 246
DE BAKEY
190 mm

17-245 77 mm
17-246 77 mm



17-247
LELAND-JONES
195 mm



17-248
DE BAKEY
200 mm

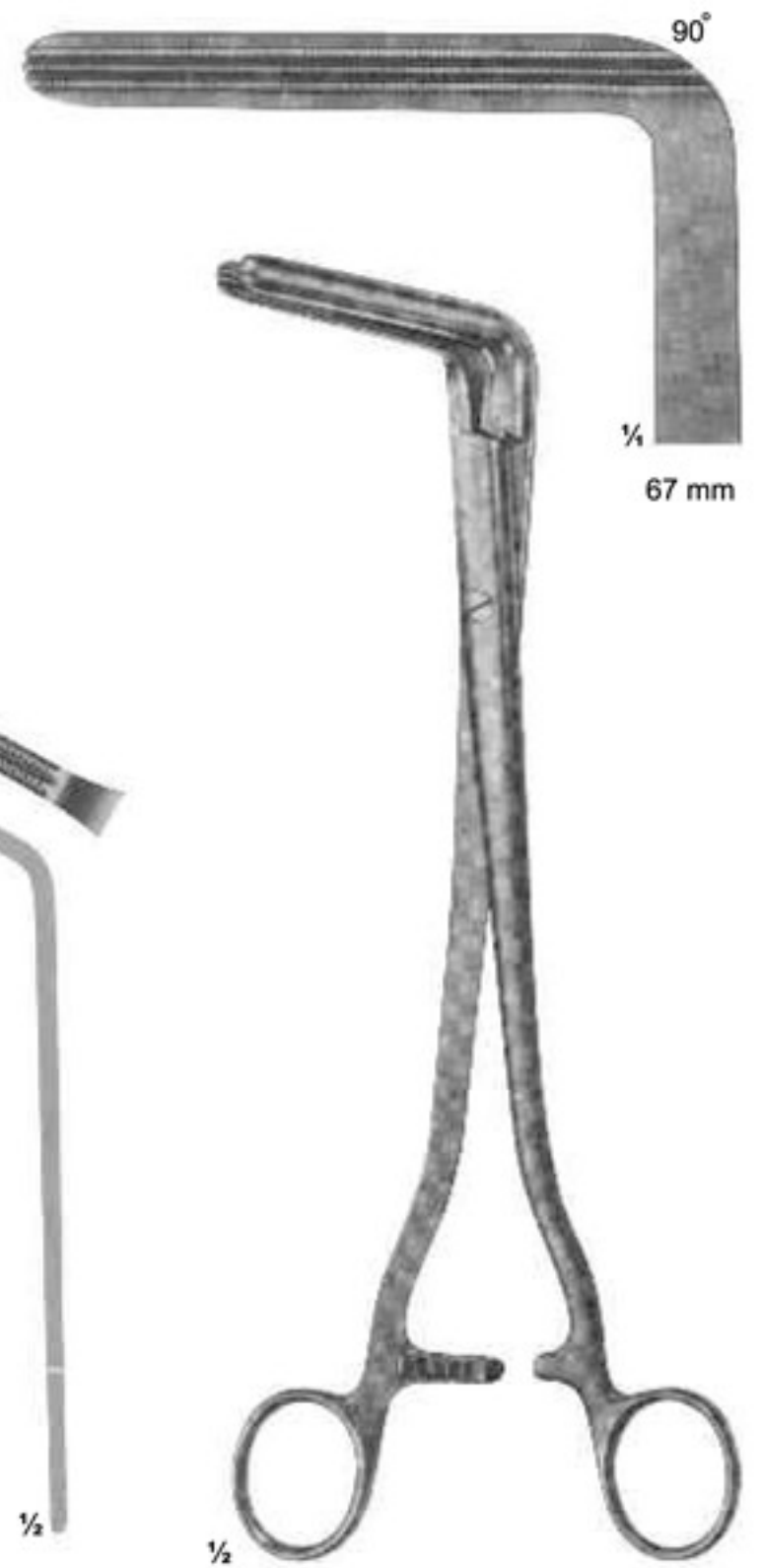

17-249
WERTHEIM
250 mm

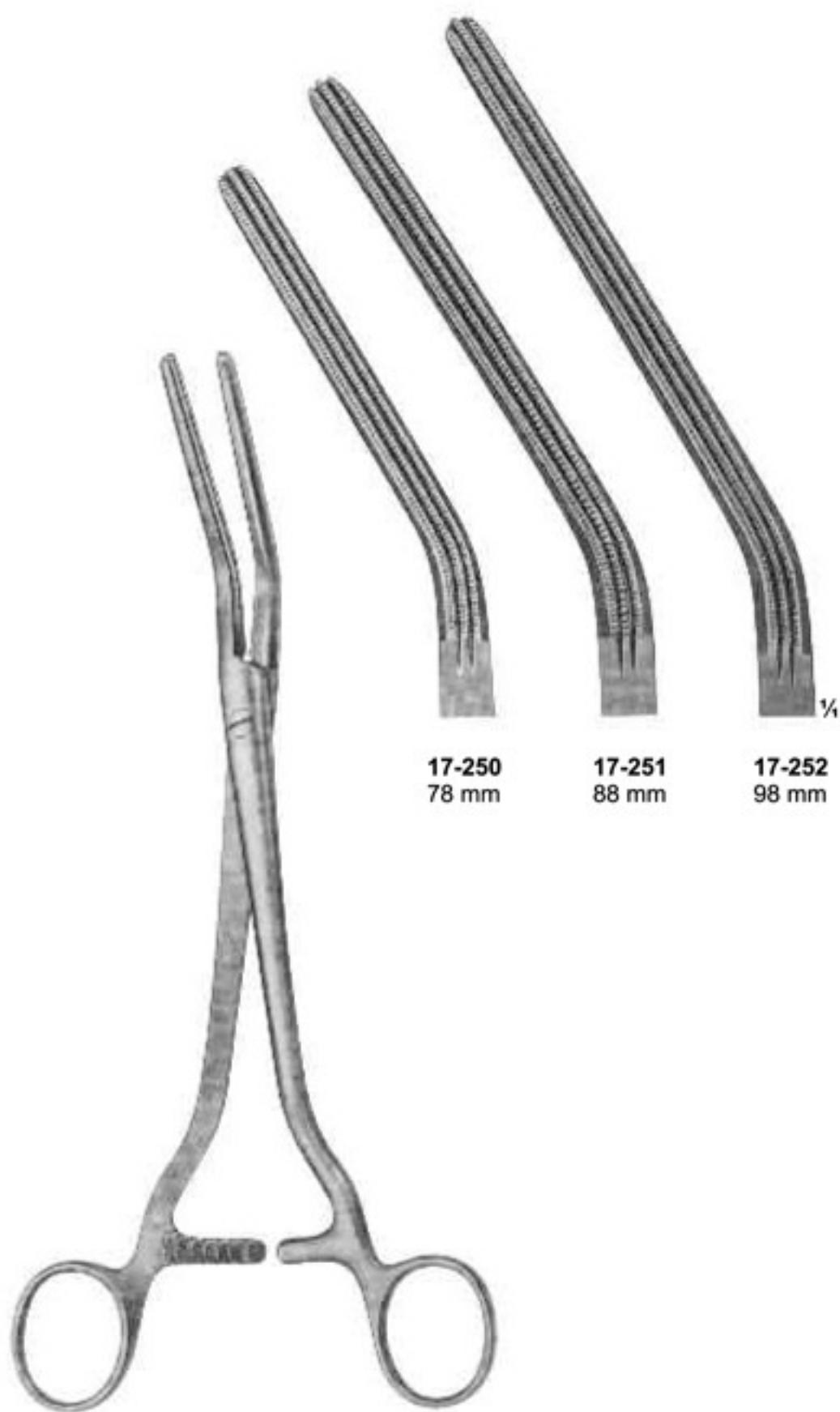

17-250
78 mm

17-251
88 mm

17-252
98 mm

17-250 - 252
DICK
255 mm, 265 mm, 275 mm

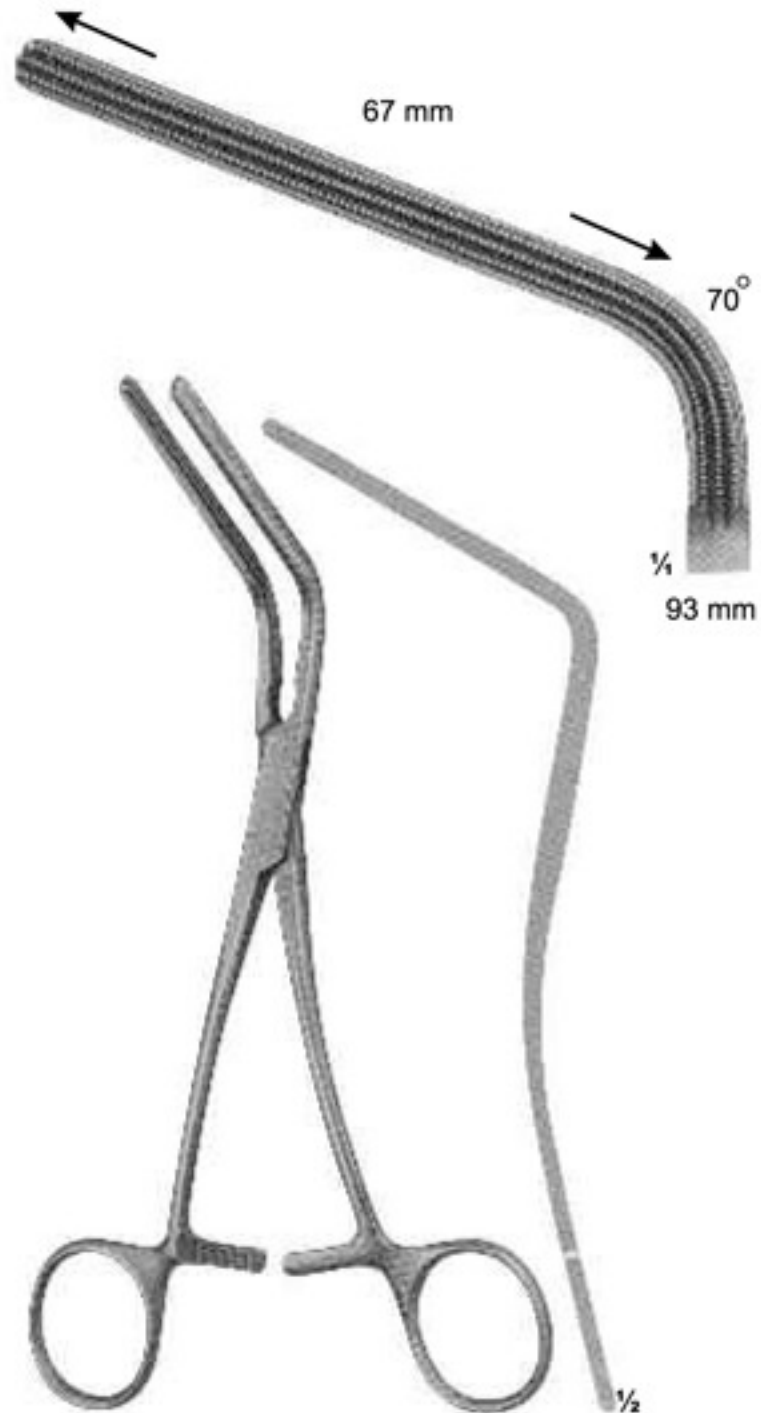

17-253
MORRIS
175 mm

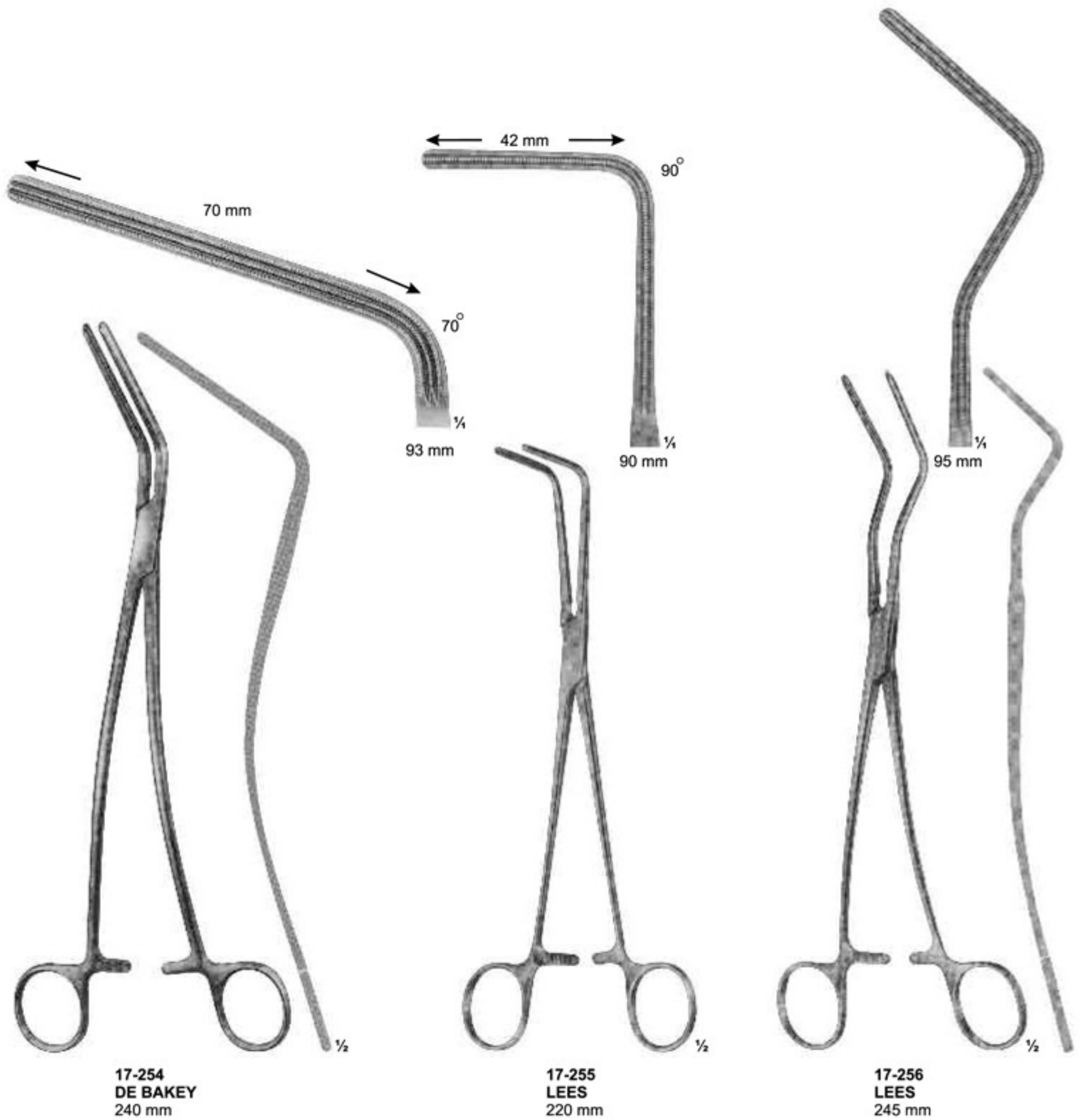

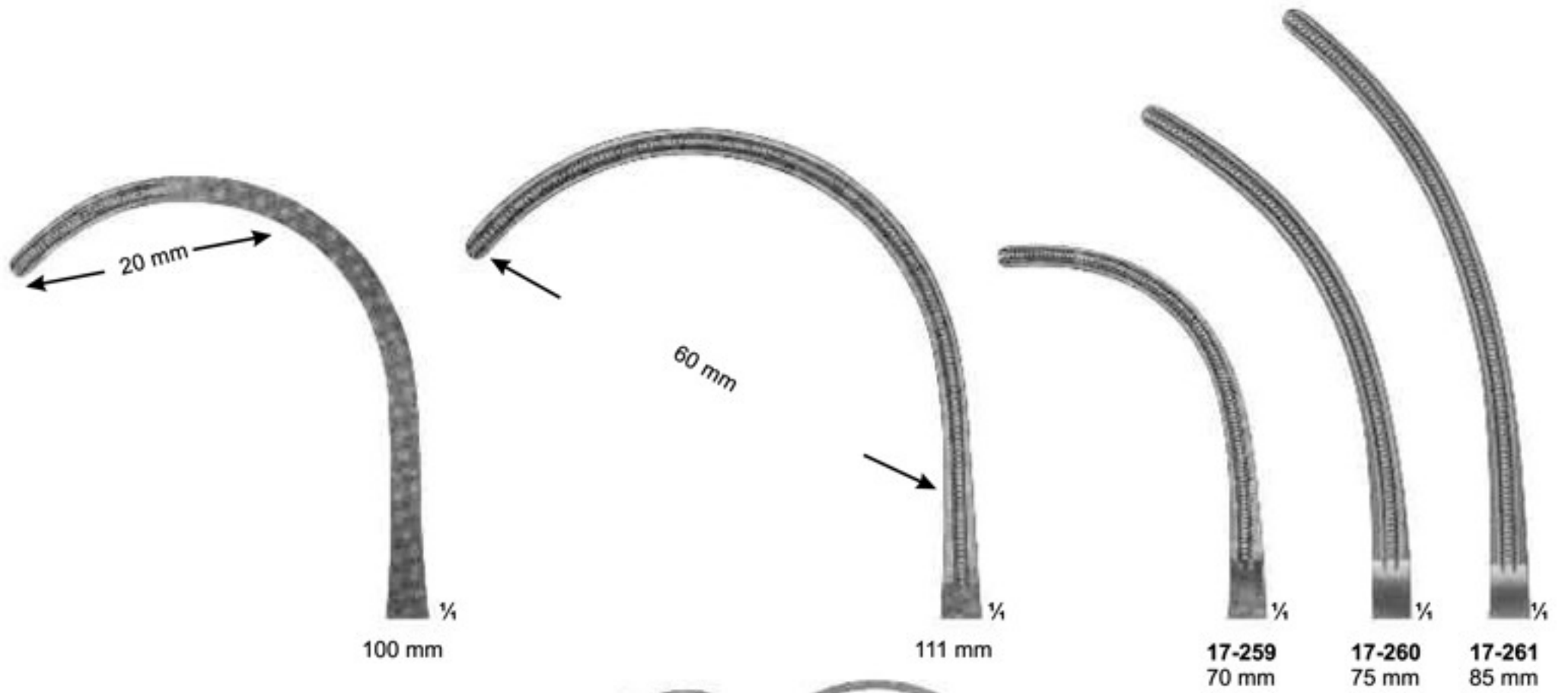

**17-257
DE BAKY**
265 mm



**17-258
DE BAKY**
270 mm

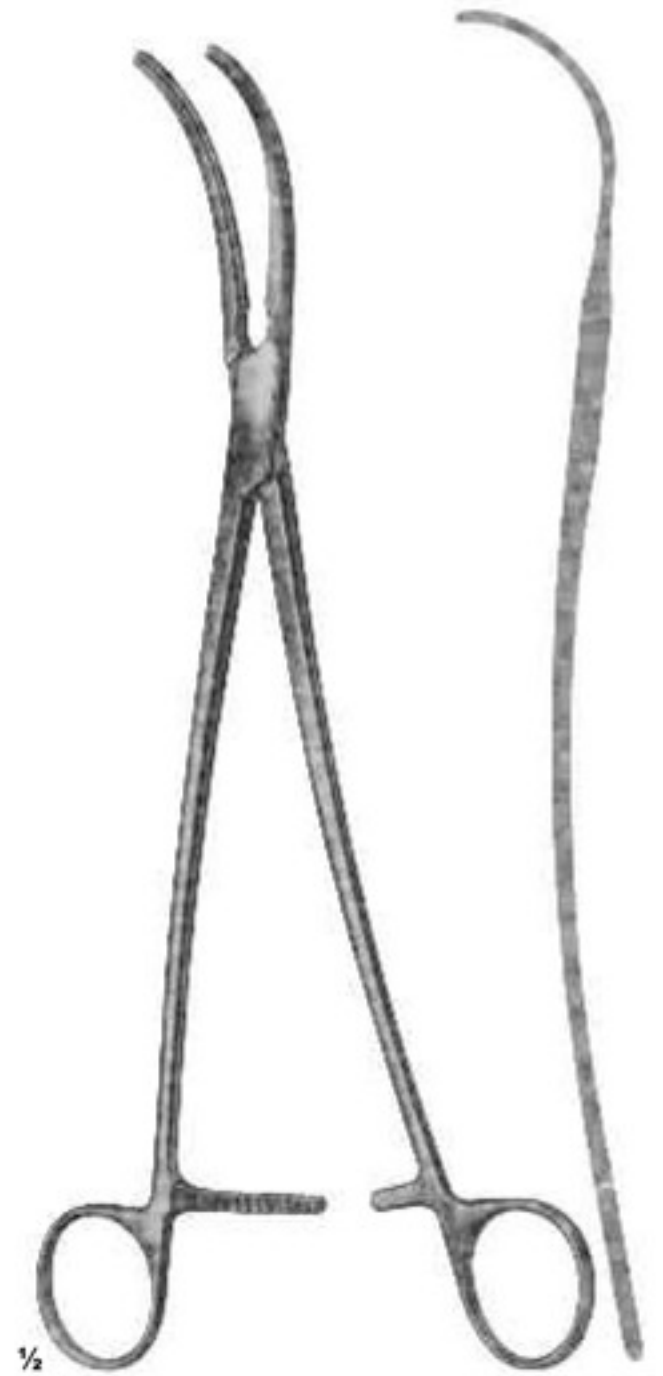

**17-259 - 261
DE BAKY**
255 mm, 265 mm, 280 mm

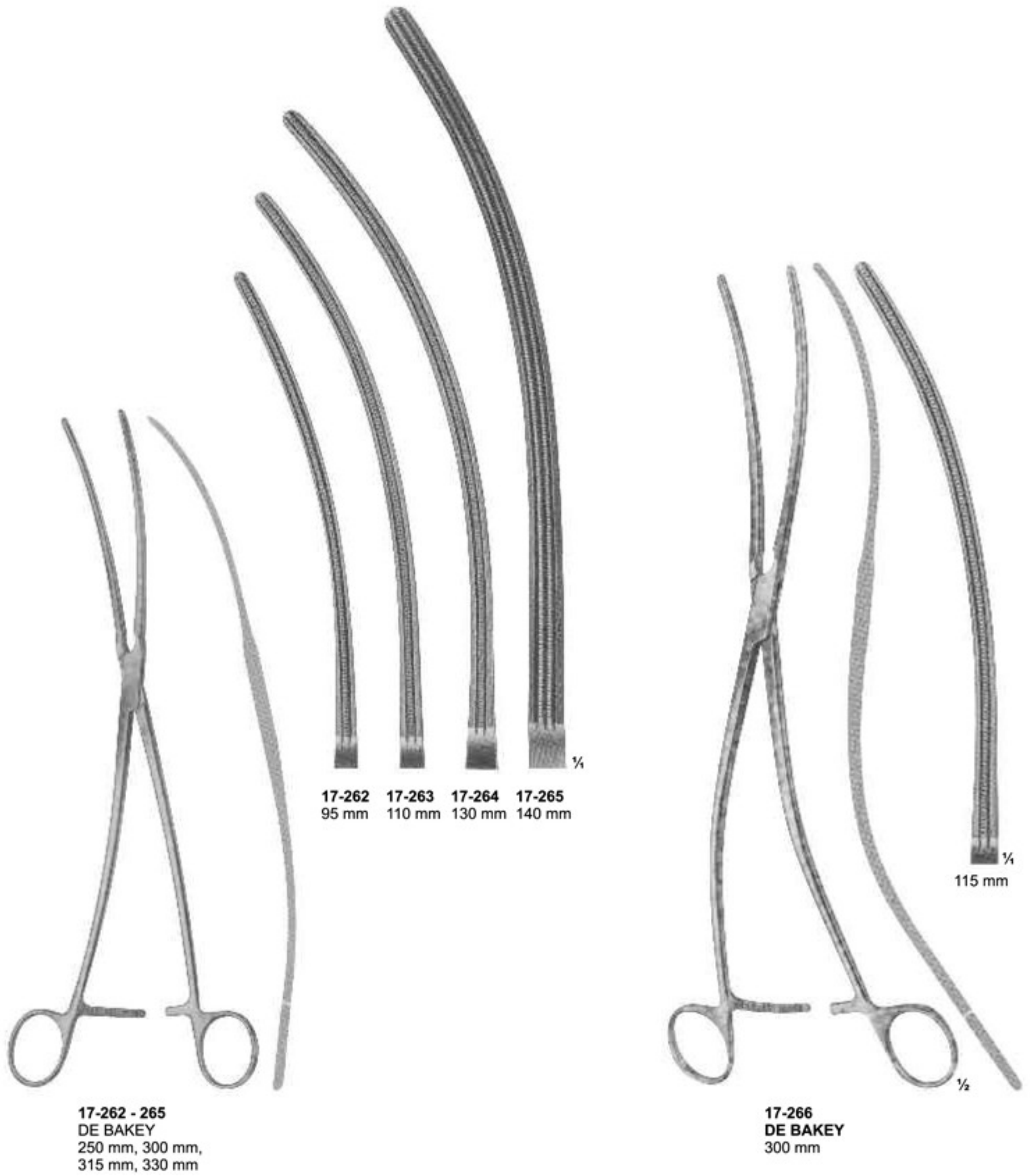

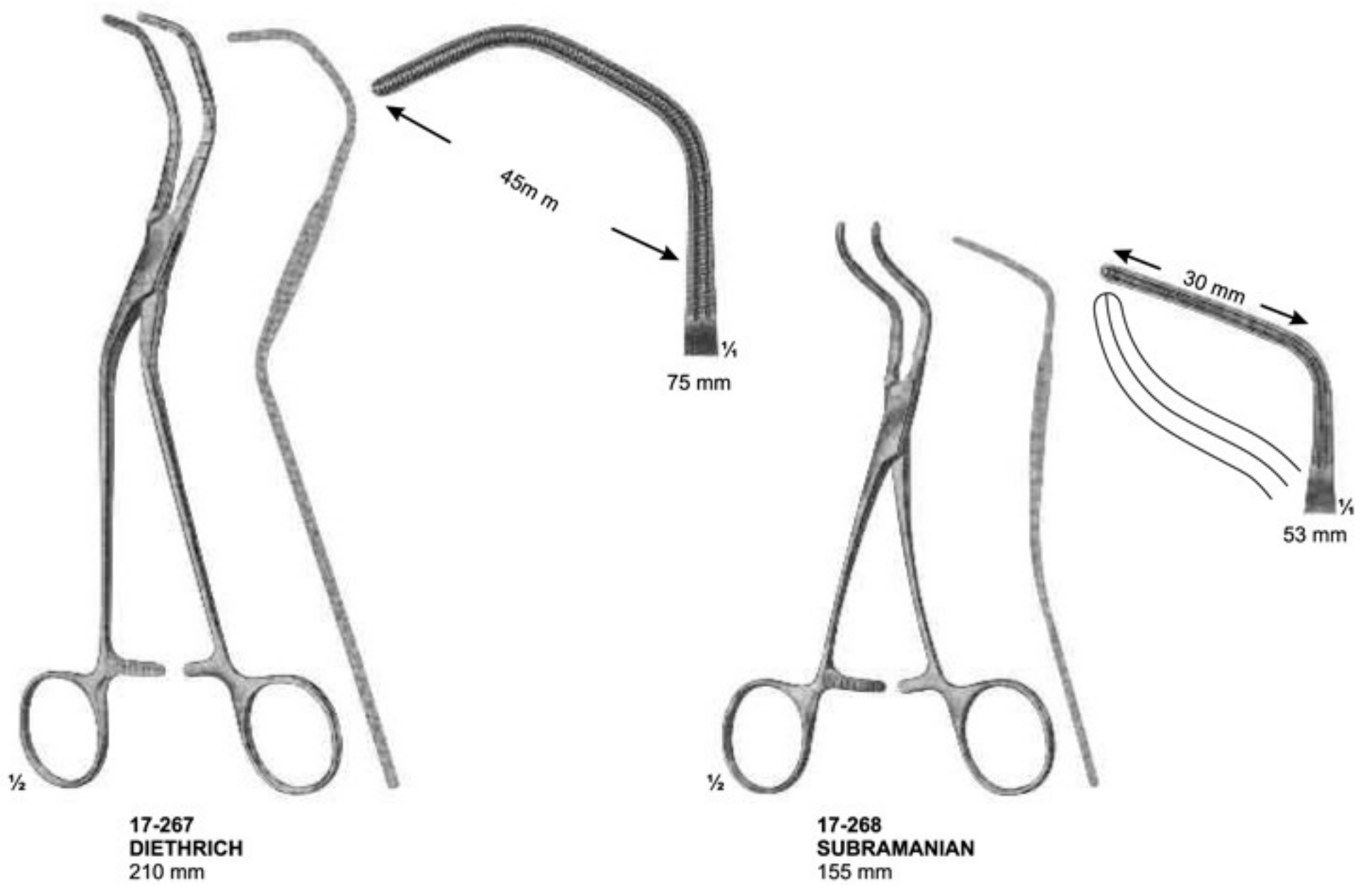

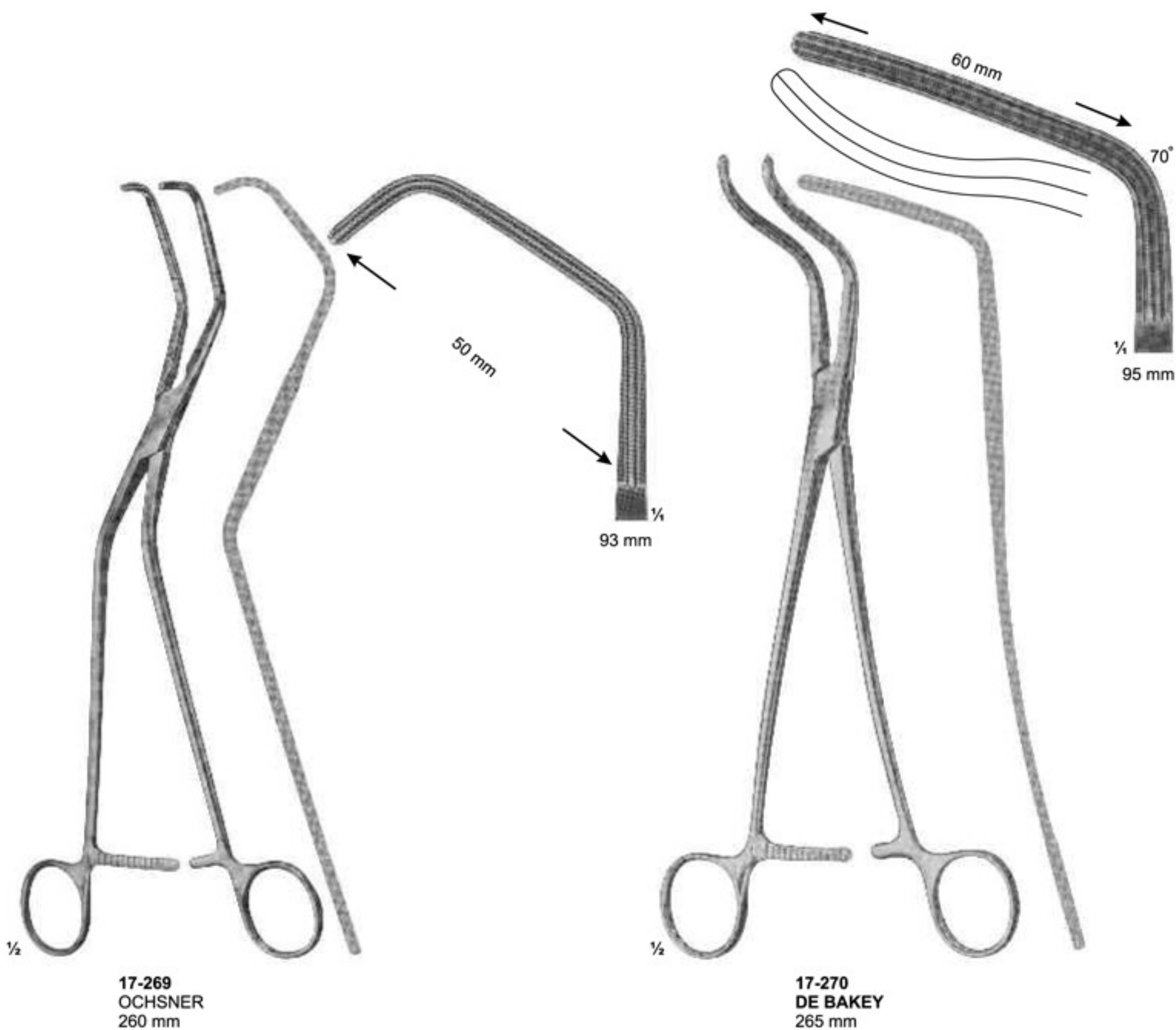

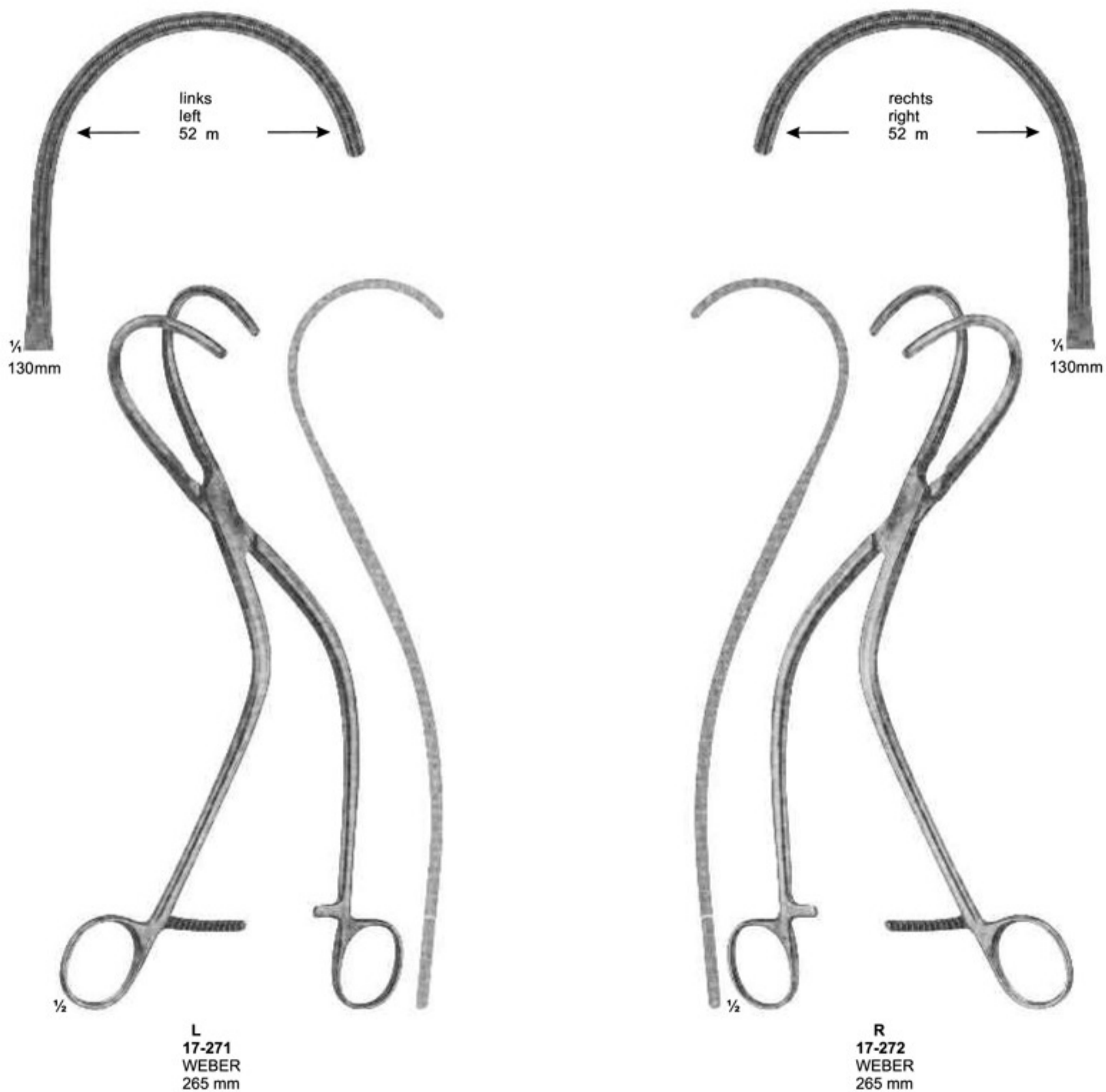



17-273 - 276
DE BAKEY

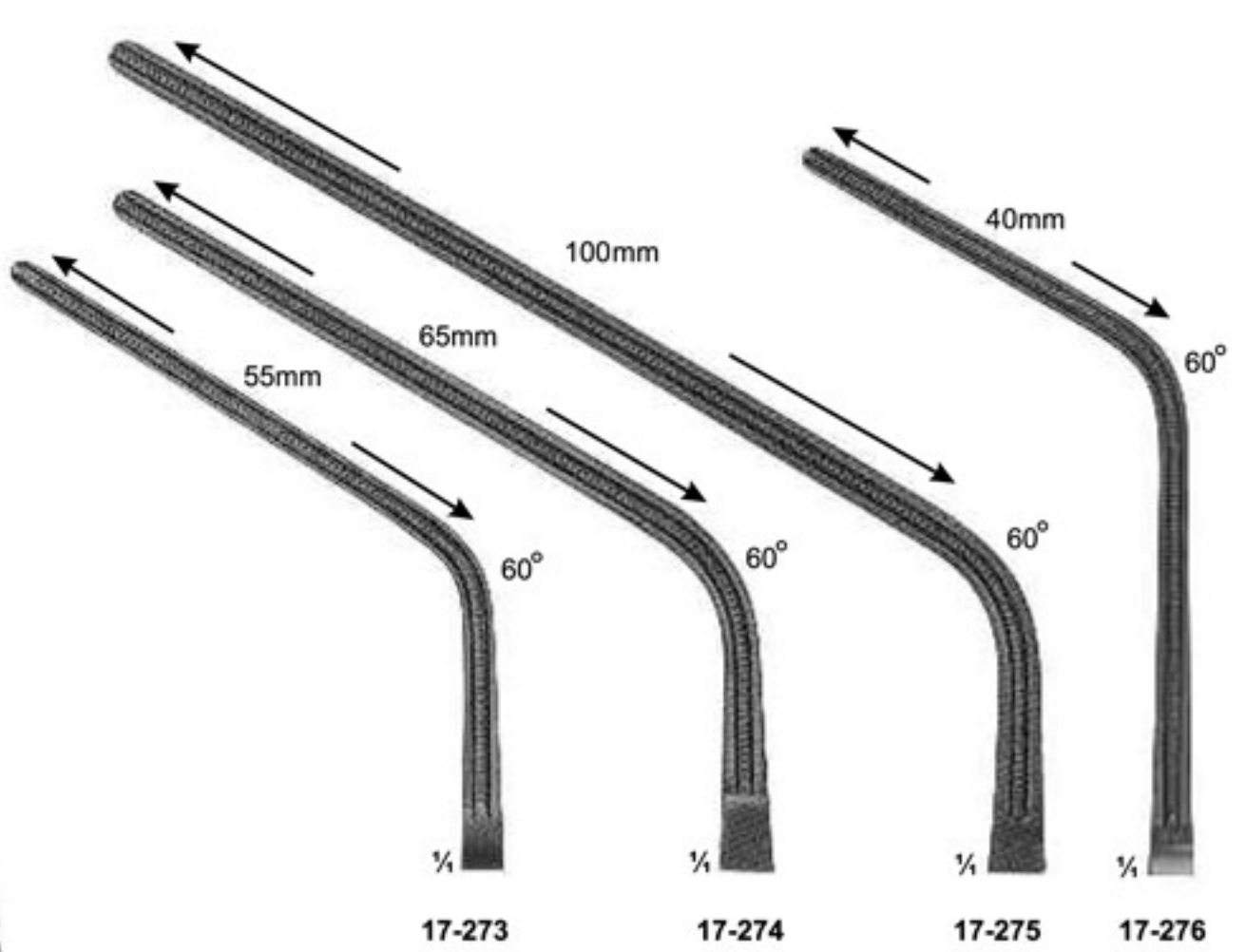

Total Length:	230 mm	280 mm	305 mm	240 mm
Length of jaws:	85 mm	100 mm	135 mm	93 mm



17-277 - 280
DE BAKEY

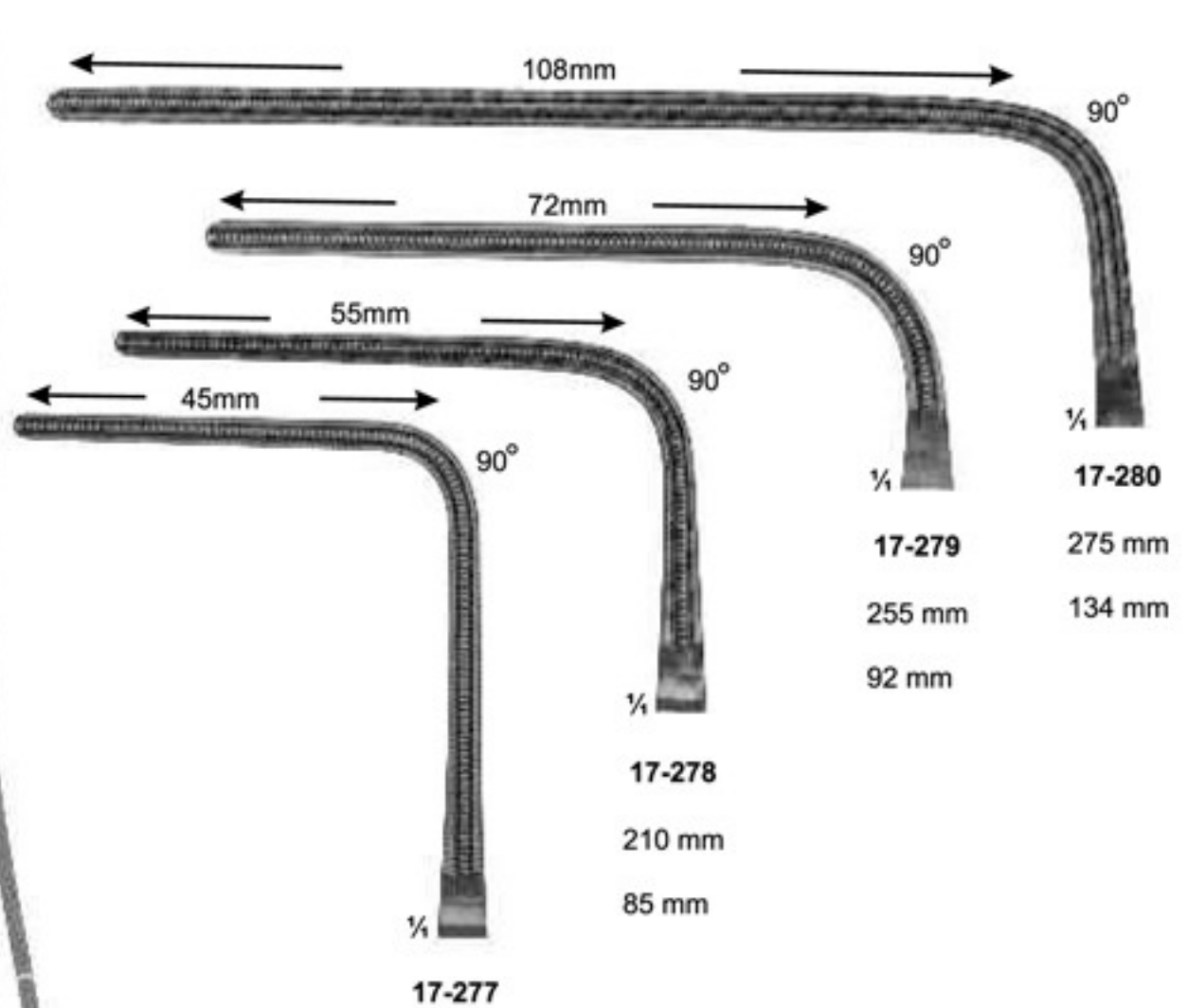

Total Length:	225 mm
Length of jaws:	93 mm

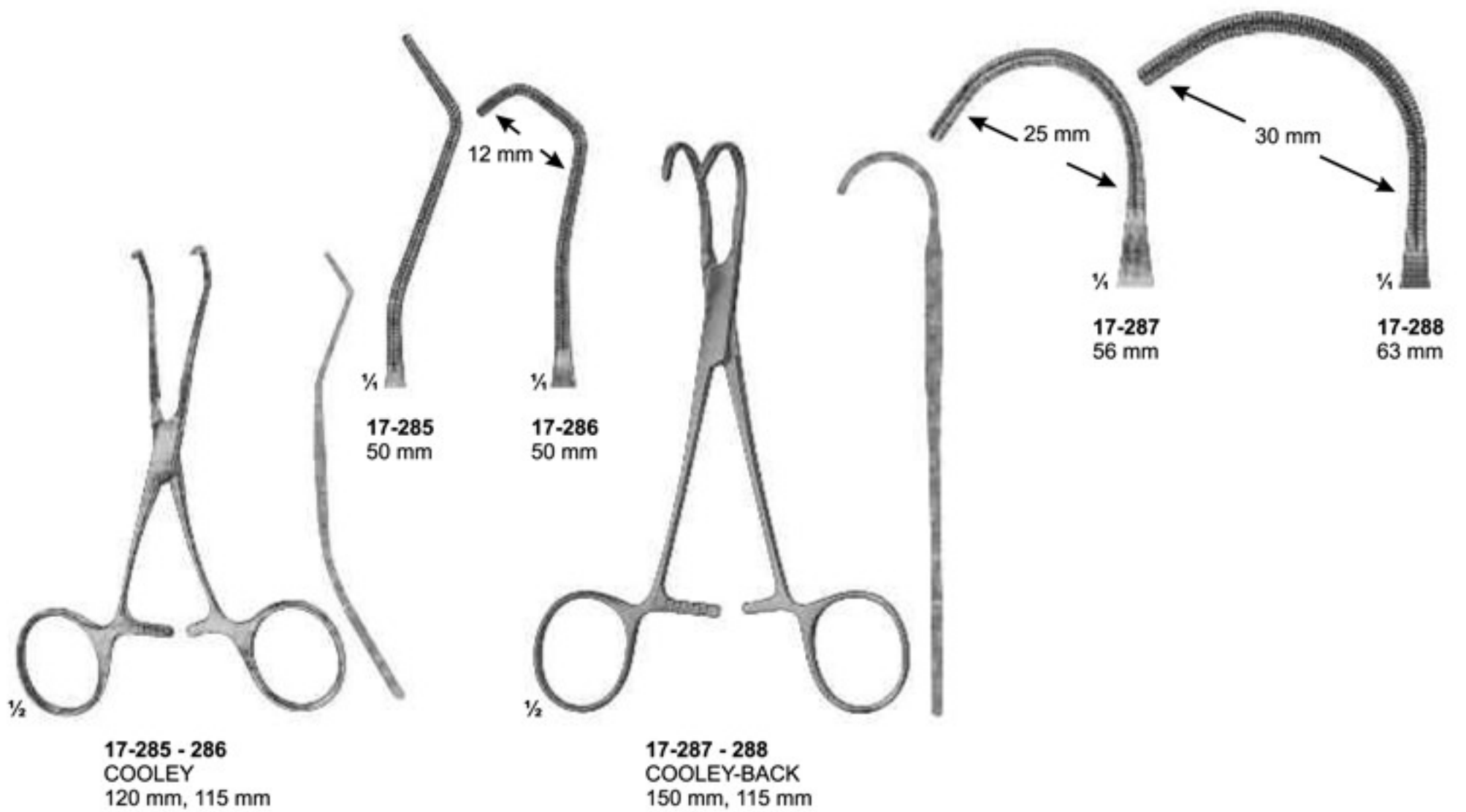
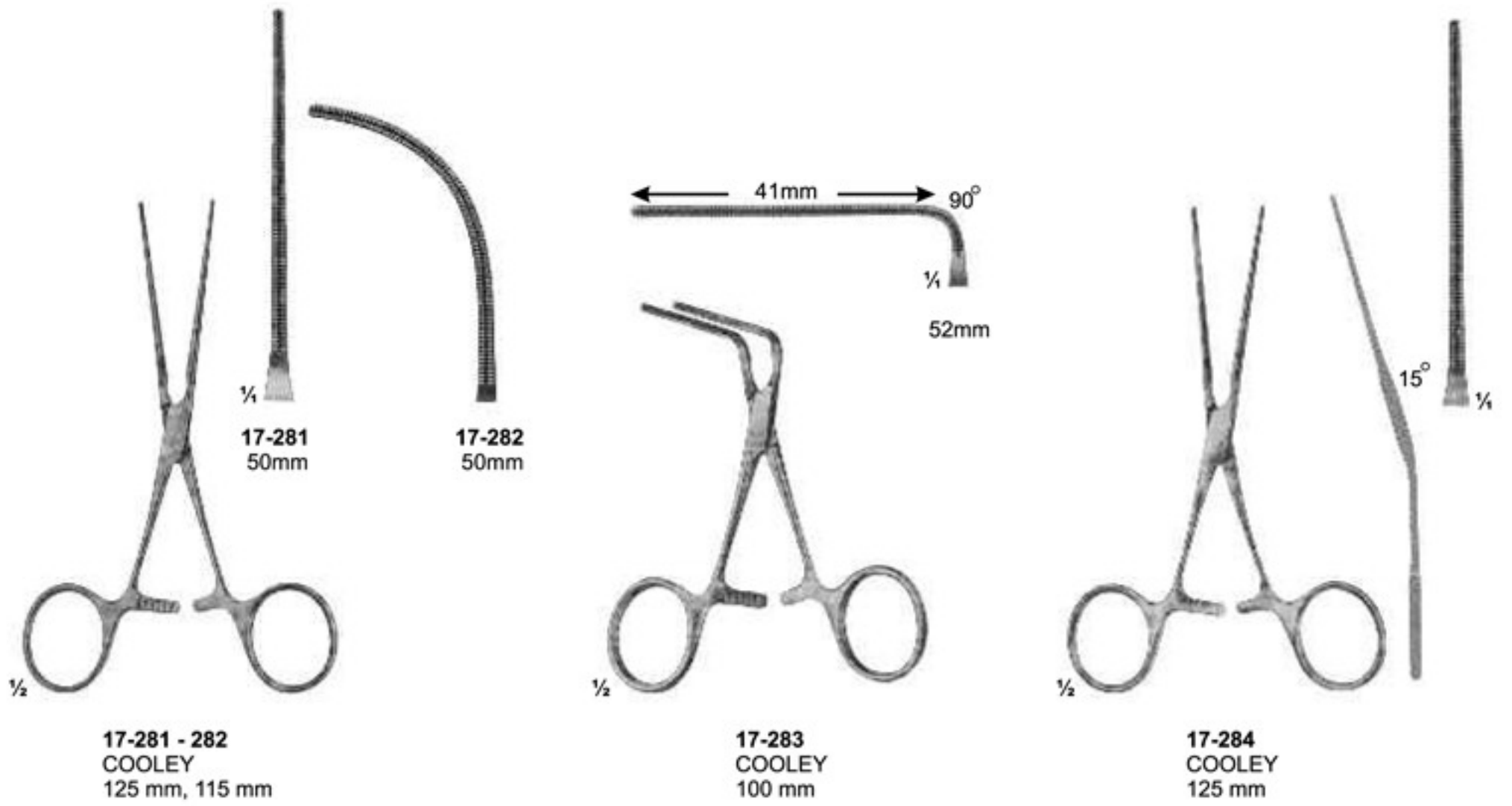

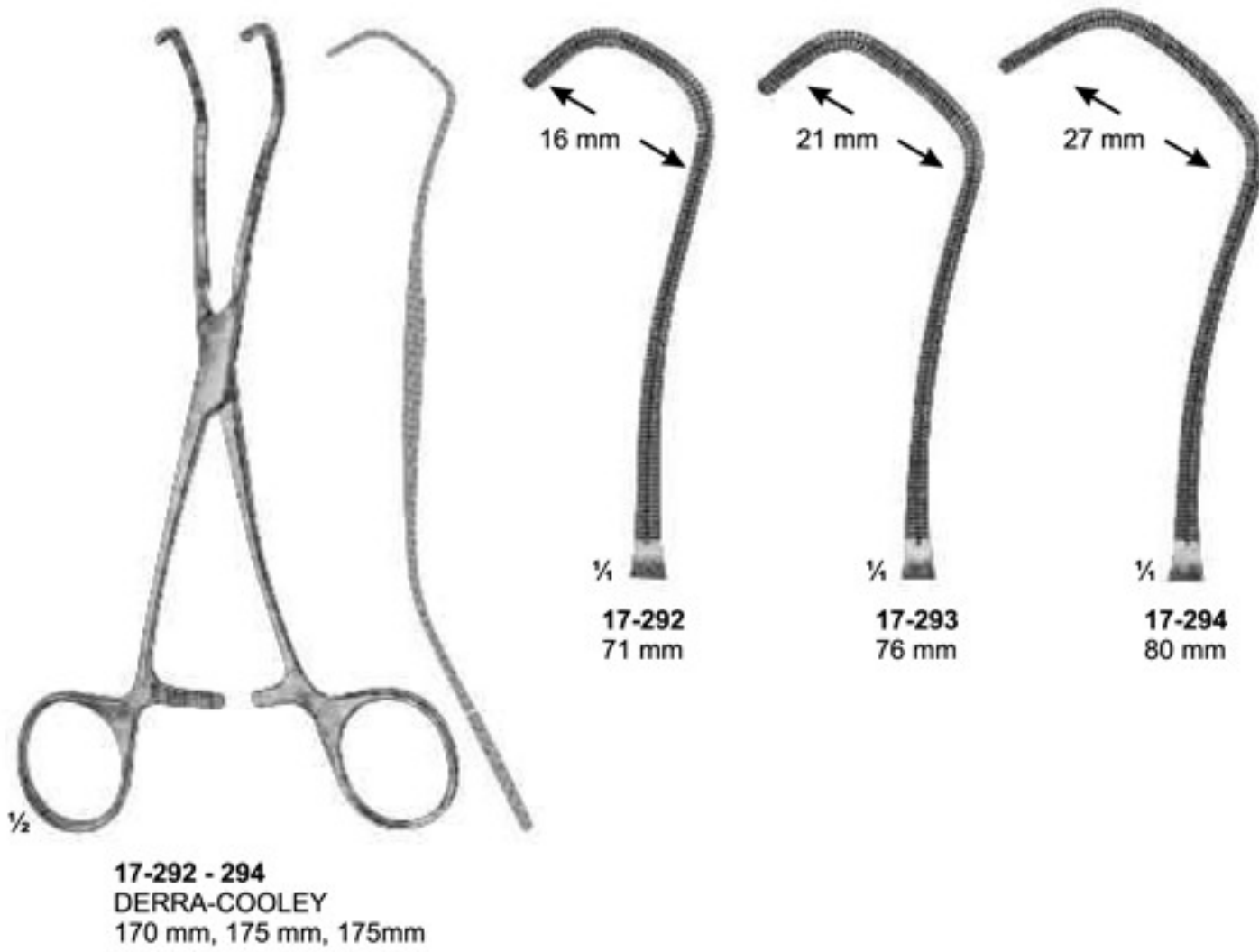
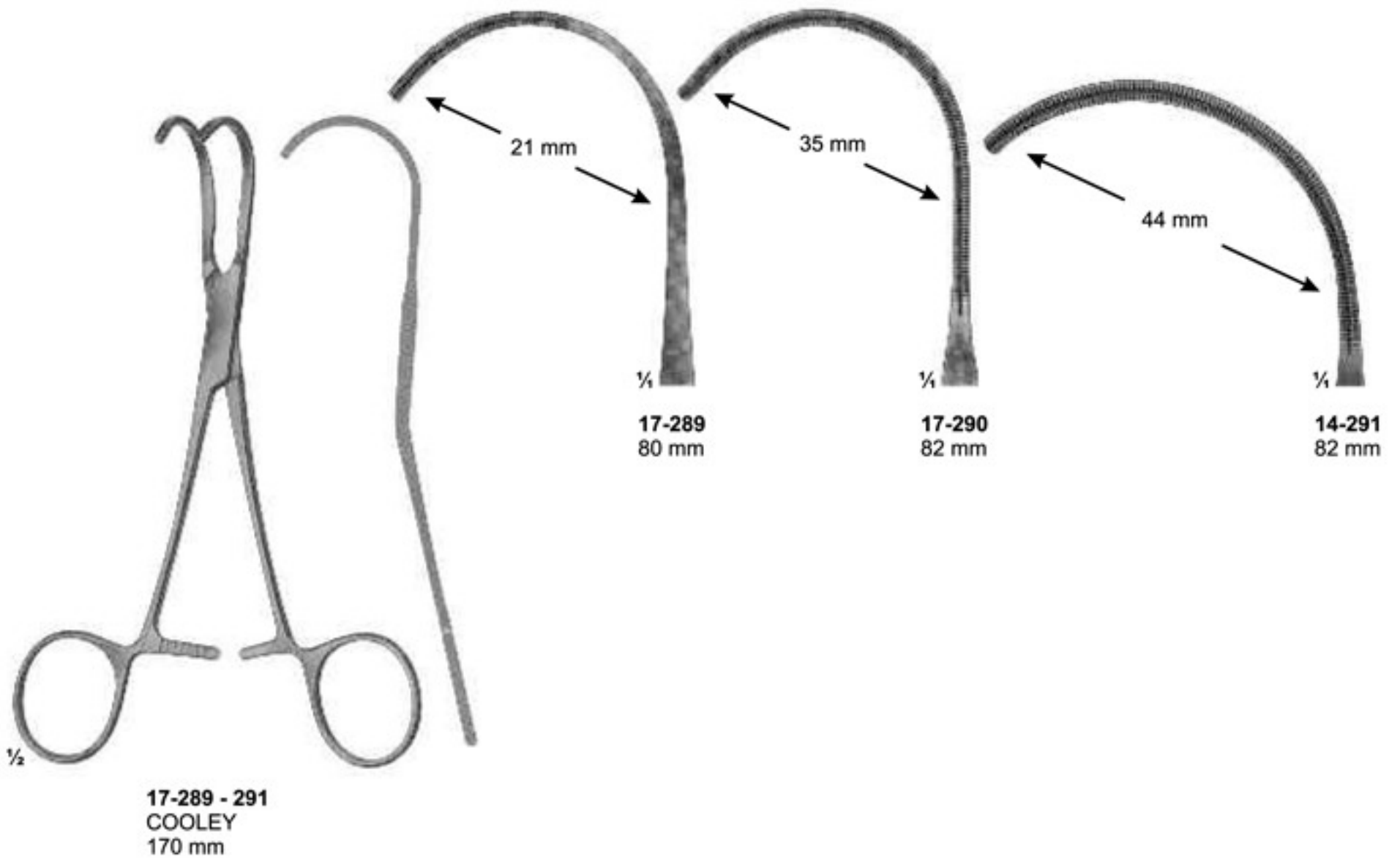

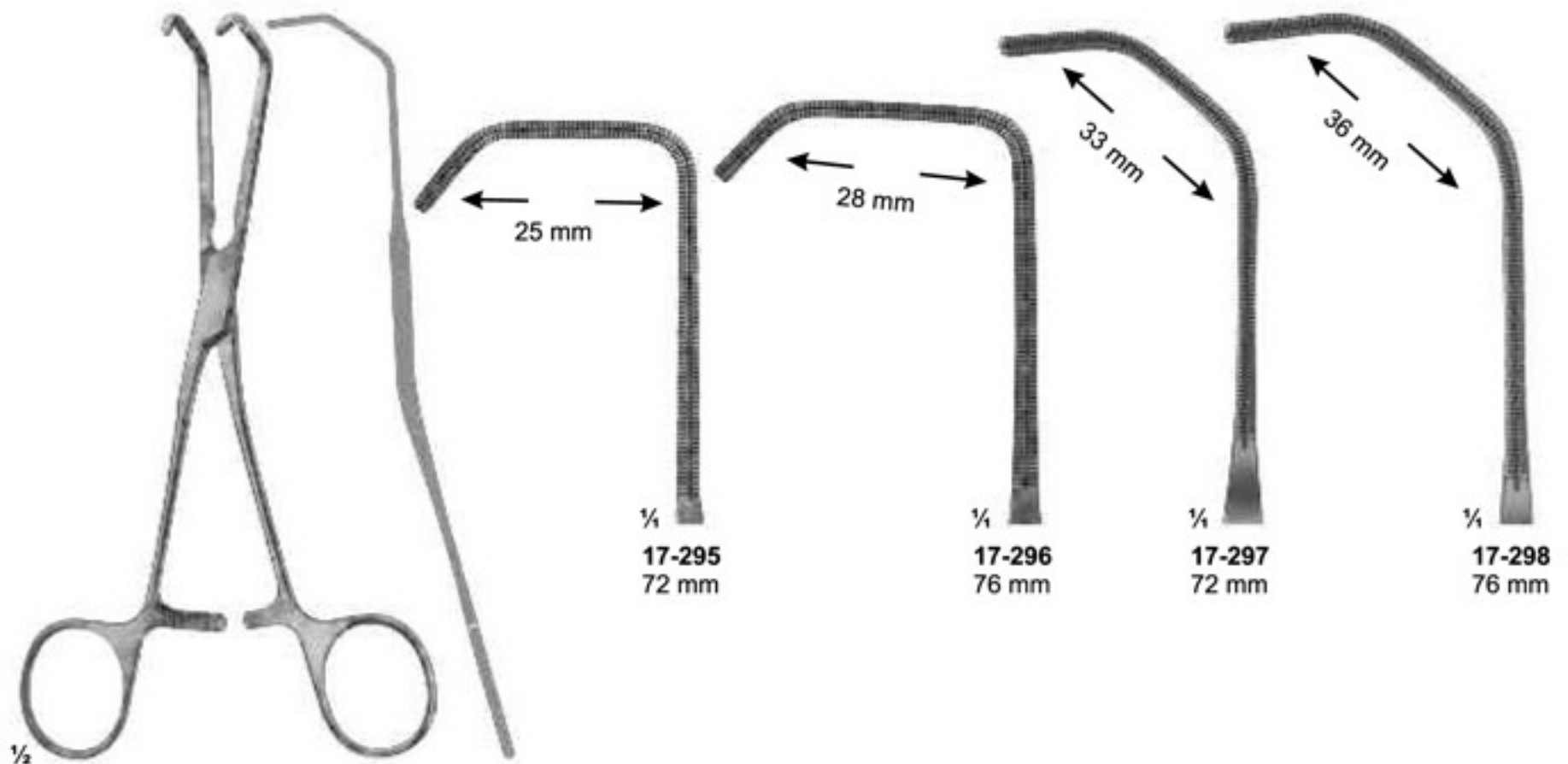

17-295 - 298
COOLEY
 165 mm, 165 mm
 175 mm, 180 mm

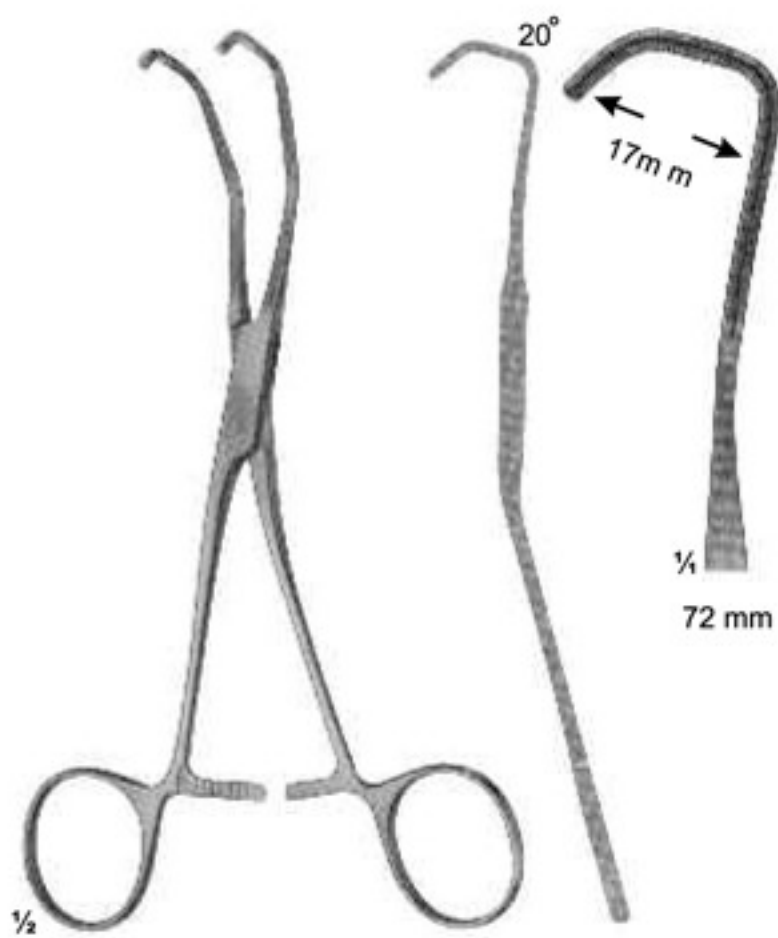

17-299
COOLEY
 170 mm

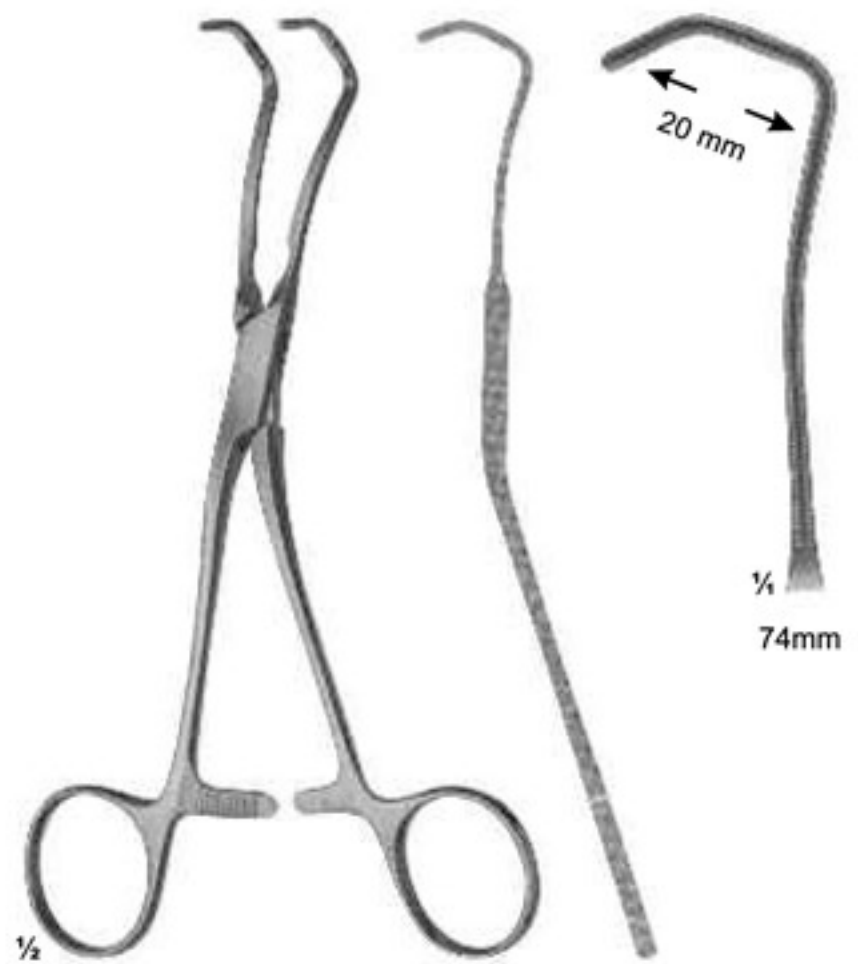

17-300
COOLEY
 175 mm

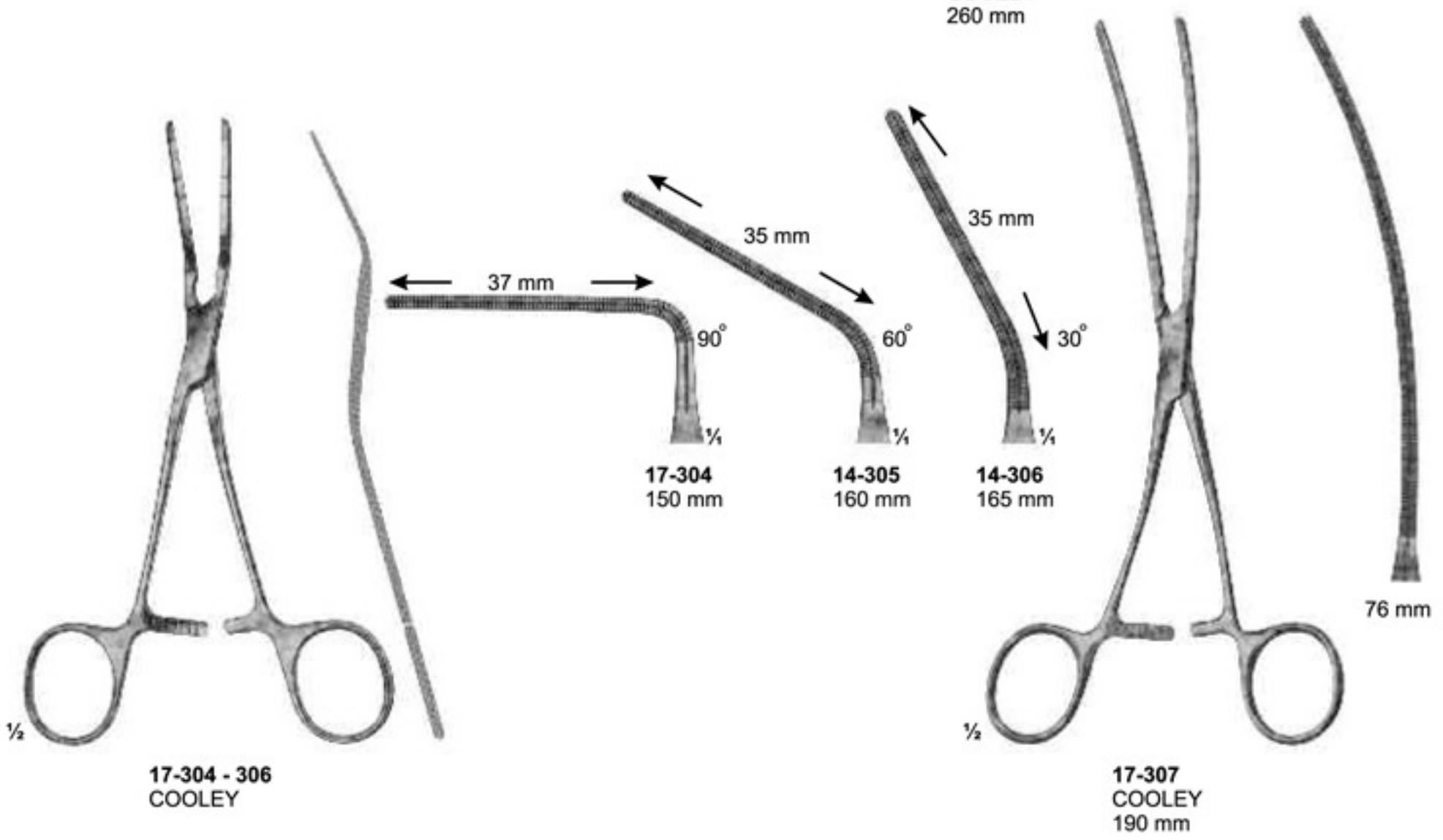
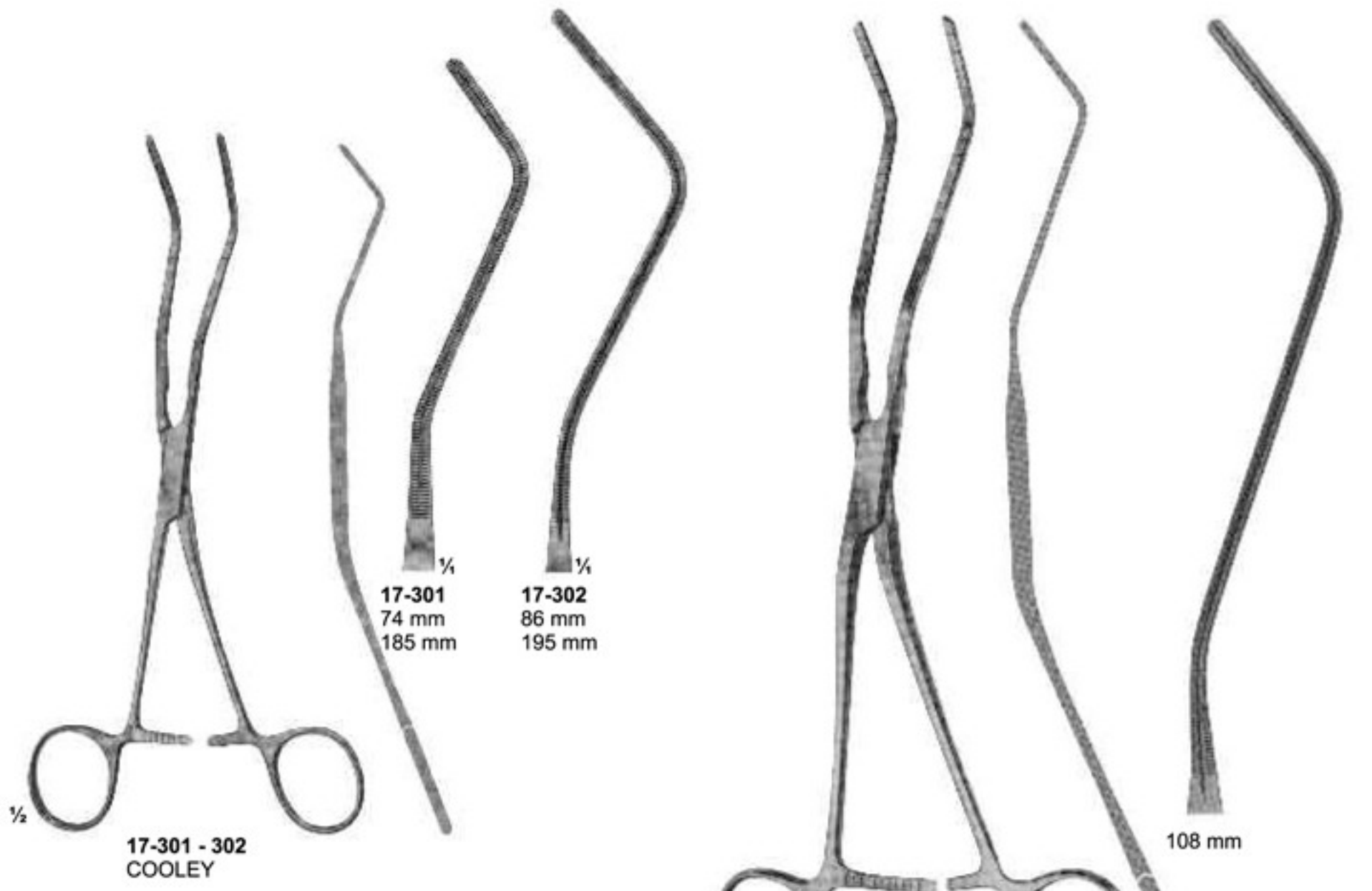

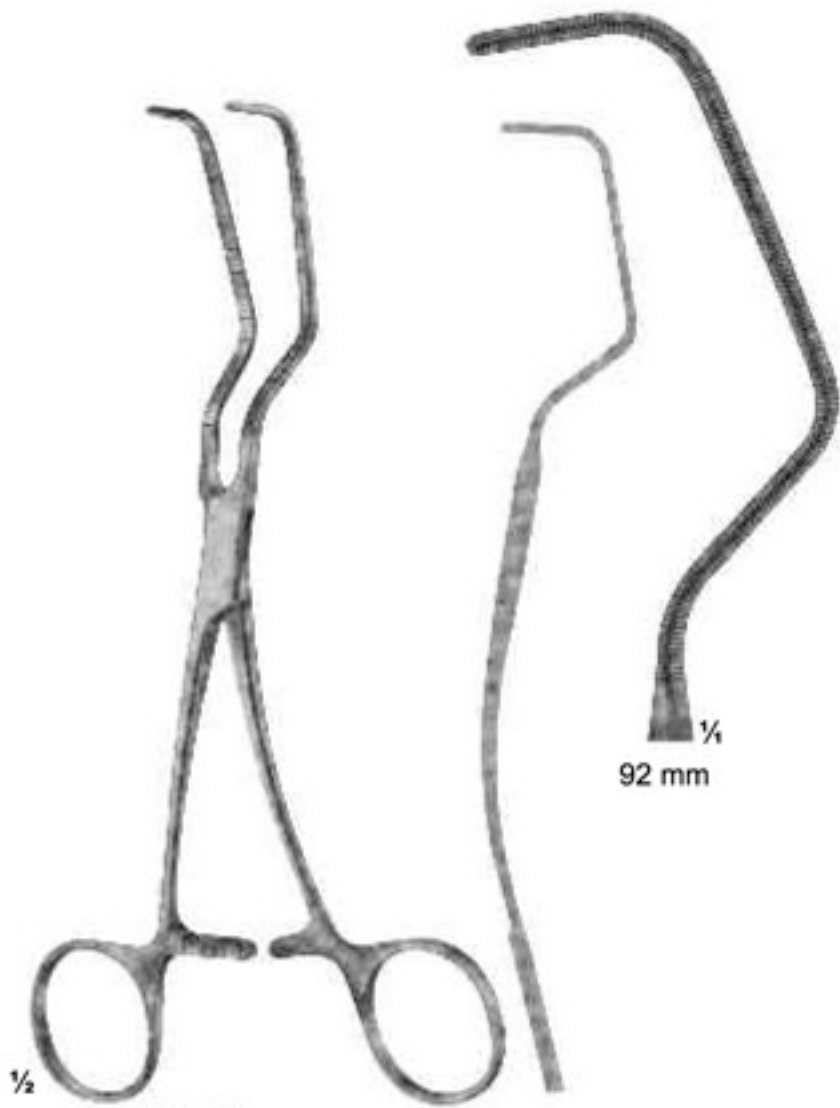

17-308
PARRY-COOLEY
185 mm

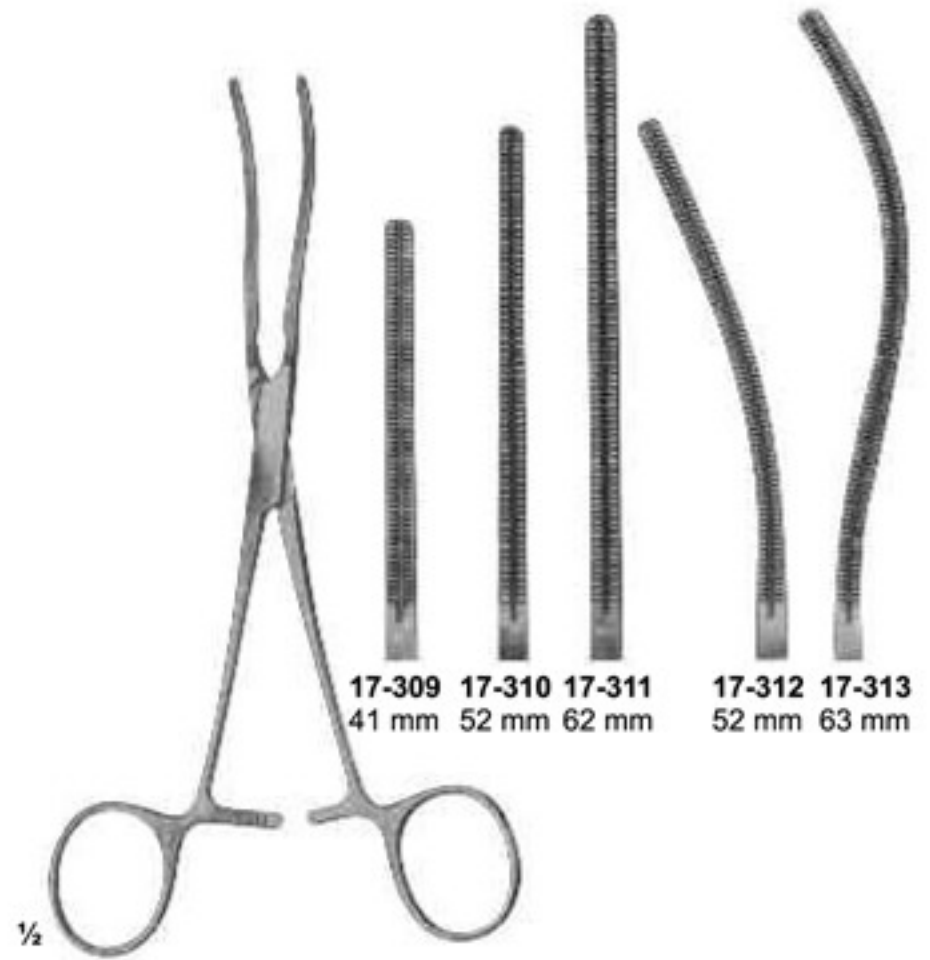

17-309 - 313
COOLEY
160 mm, 170 mm, 180 mm

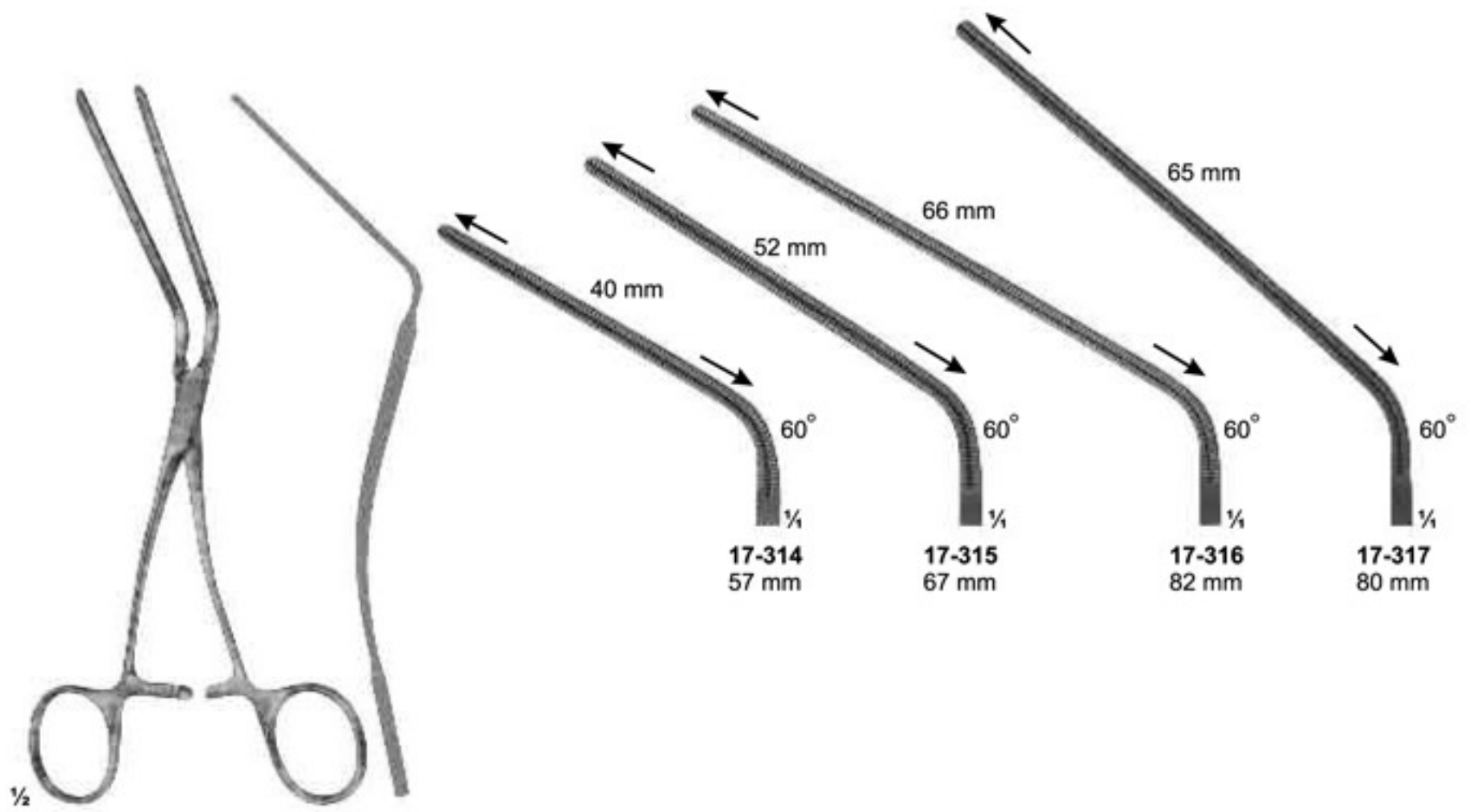

17-314 - 317
165 mm, 170 mm,
185 mm, 185 mm



DARDIK			
17-318	150 mm	17-323	170 mm
17-319	150 mm	17-324	170 mm
17-320	150 mm	17-325	170 mm
17-321	145 mm	17-326	160 mm
17-322	130 mm	17-327	135 mm

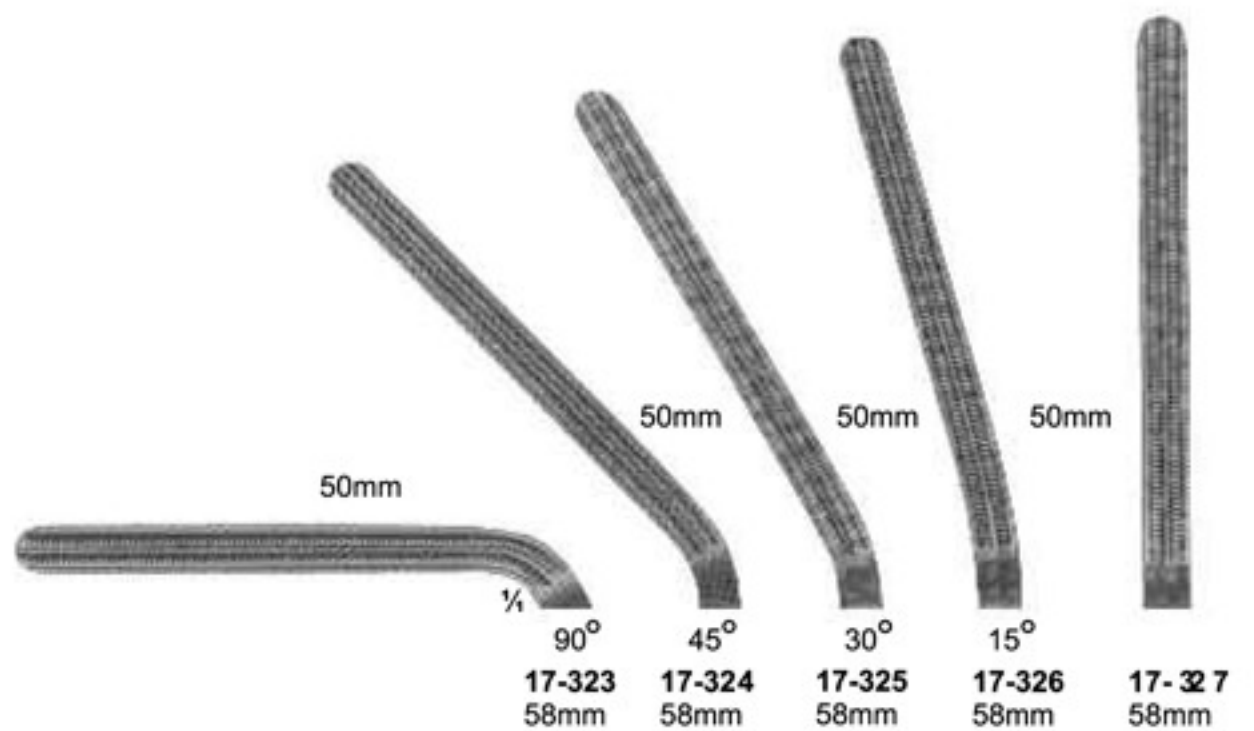
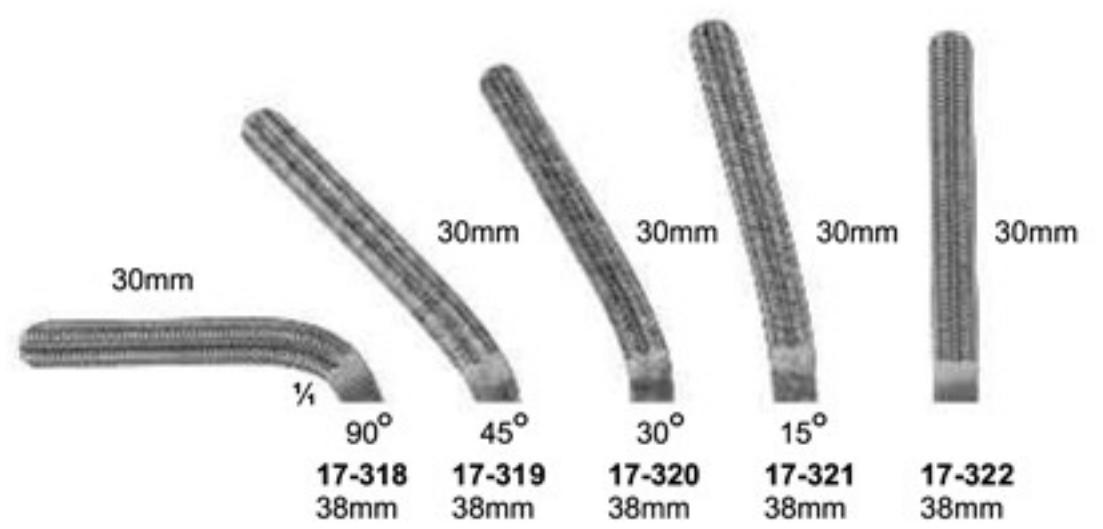



17-328
WILLIAMS
160 mm



17-329
TUTTLE
230 mm



17-330
NELSON
230 mm



17-331
DUVAL
230 mm

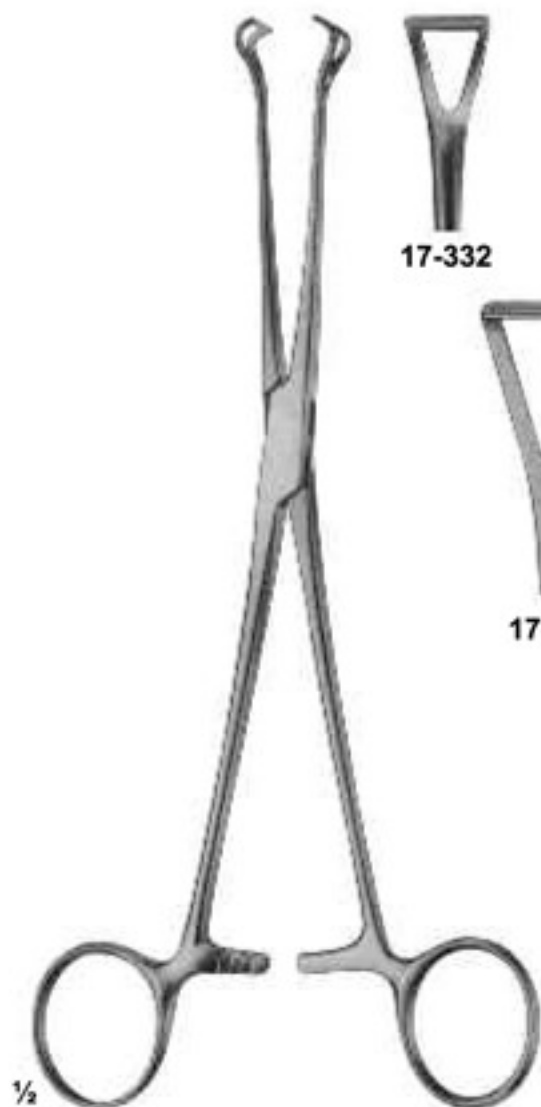

BABCOCK
17-332 170 mm
17-333 215 mm
17-334 220 mm



17-335
ALLIS
220 mm

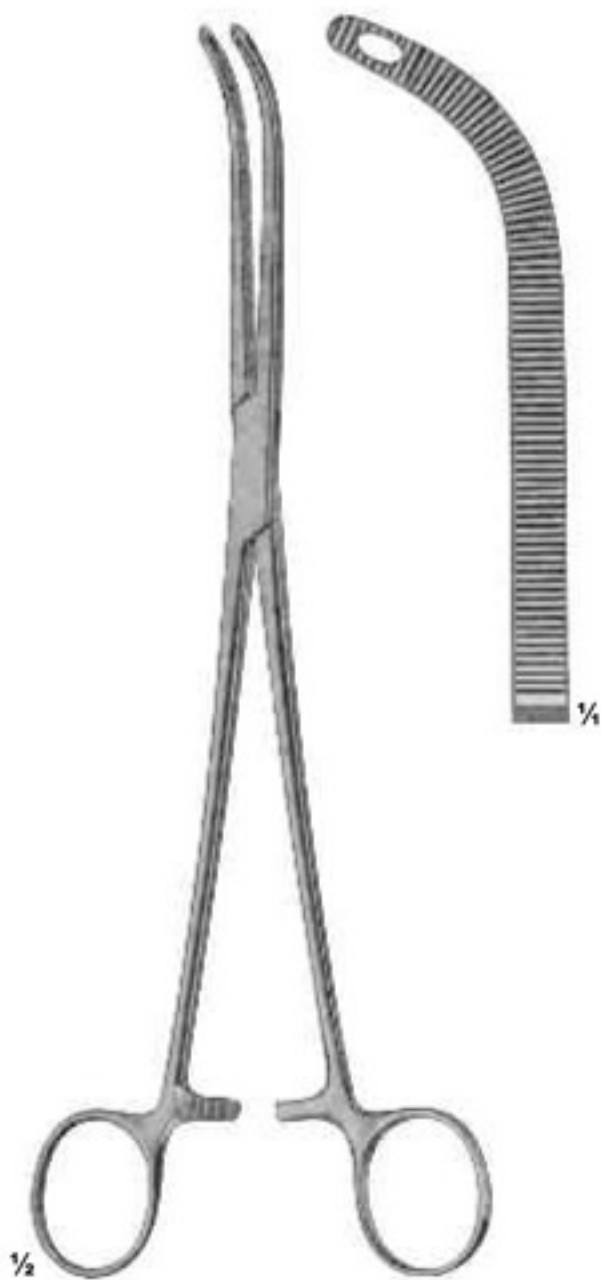

17-336
FINOCHIETTO
245 mm

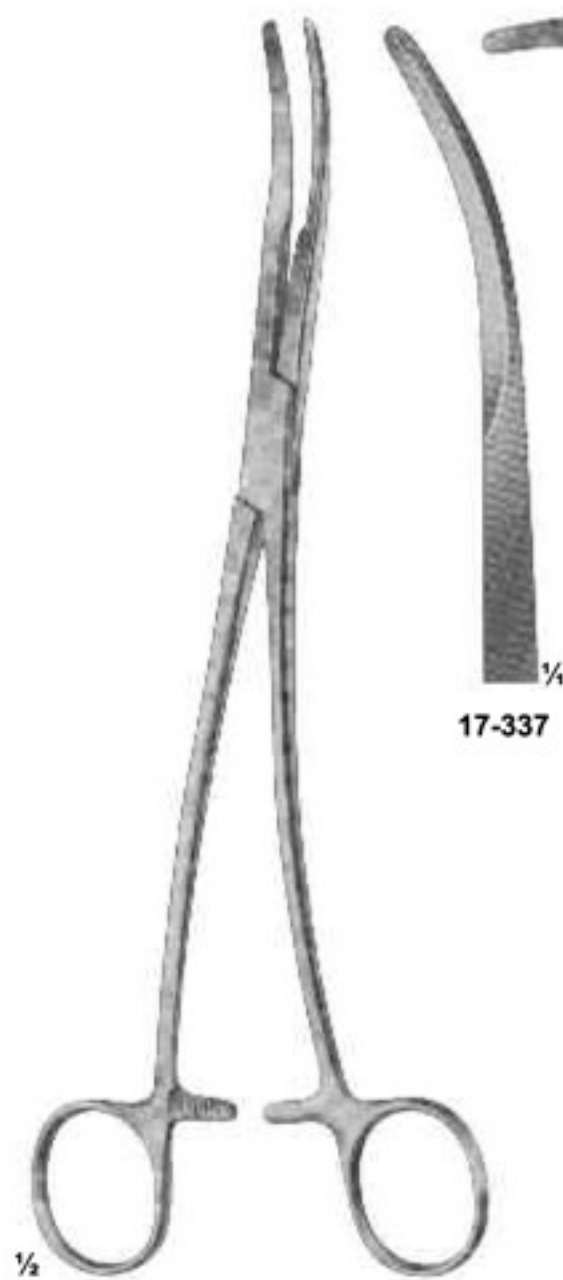

17-337 - 338
SEMB
244 mm

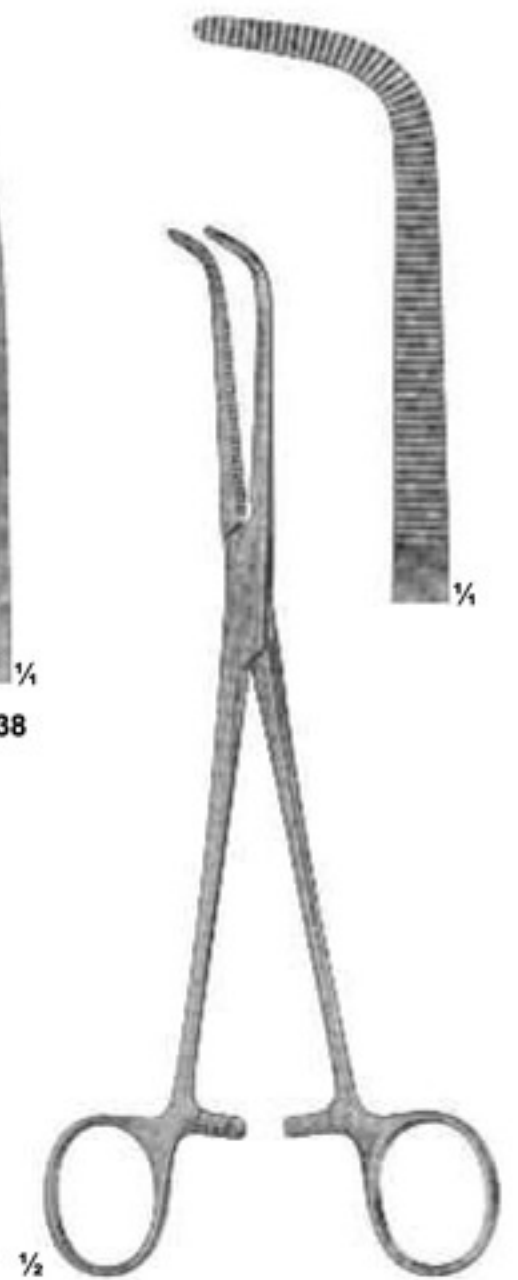

17-339
WIKSTROEM
205 mm



17-340
MIXTER
230 mm

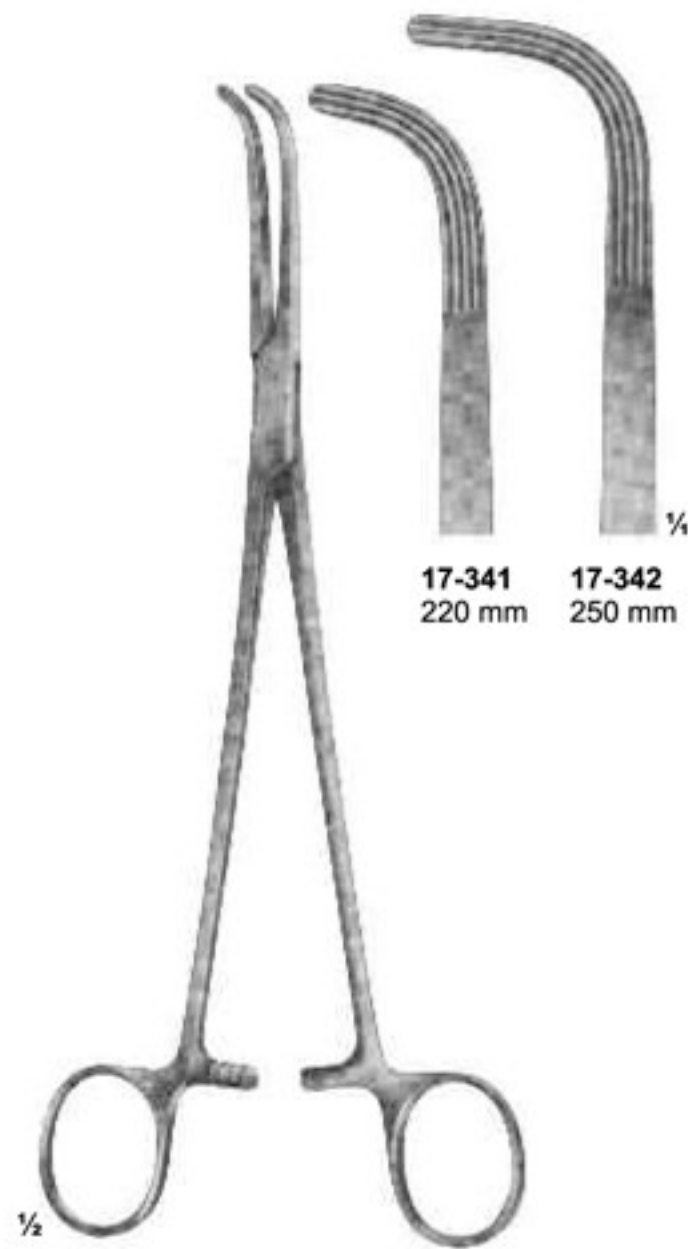

17-341 - 342
MIXTER

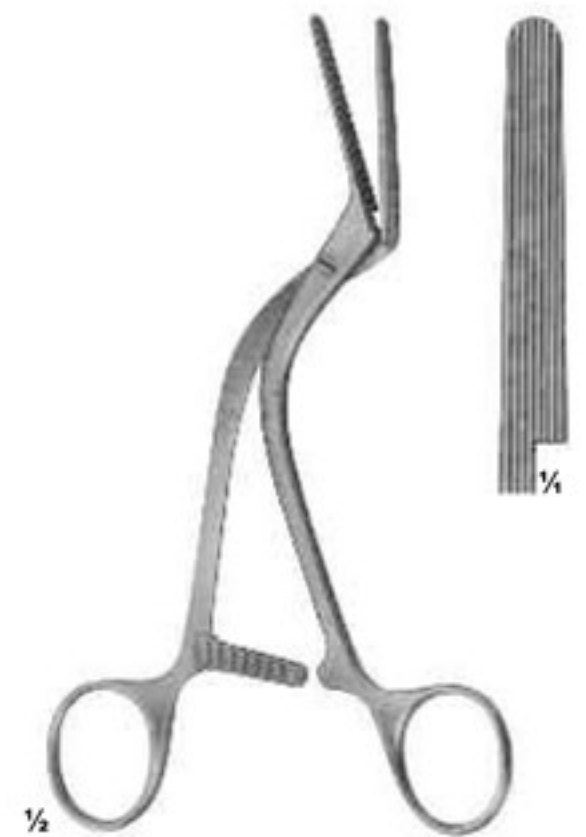

17-343
HOPFNER
160 mm

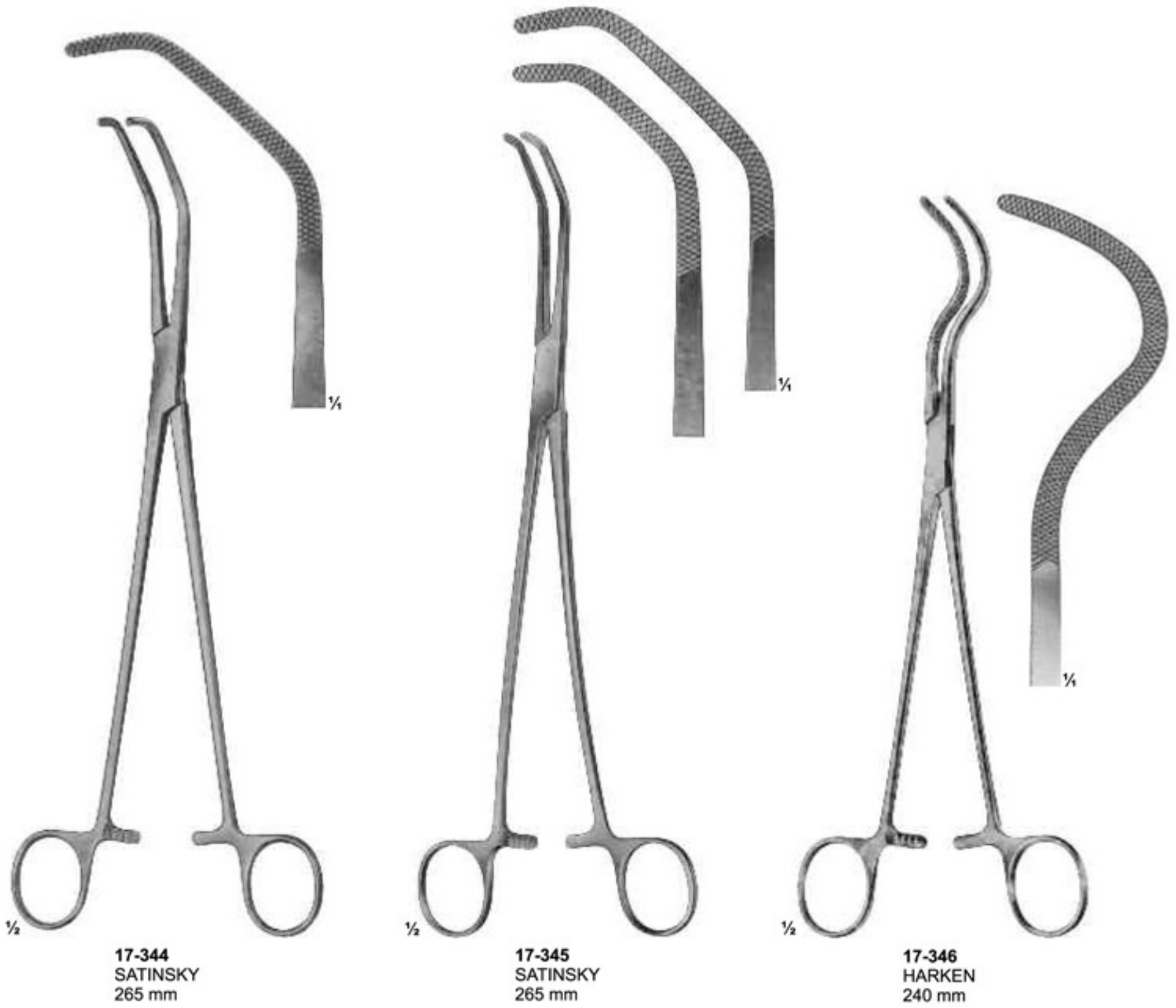



17-347
PERTUISET
Carotid Clamp
90 mm

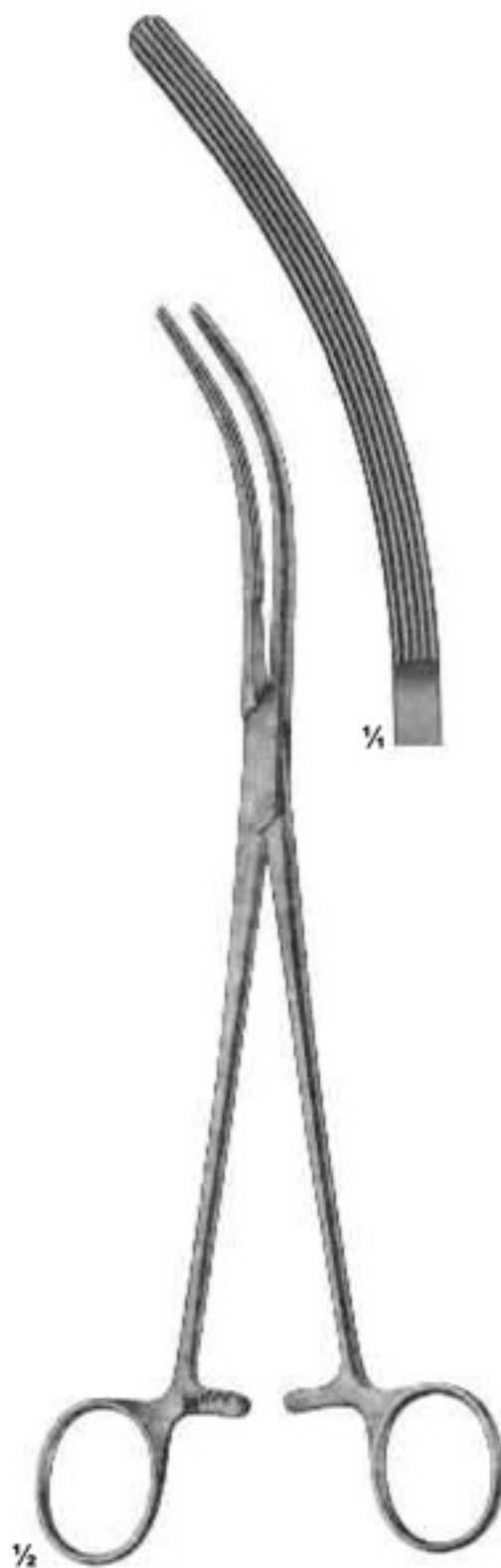

17-348
CRAFOORD-SELLORS
240 mm

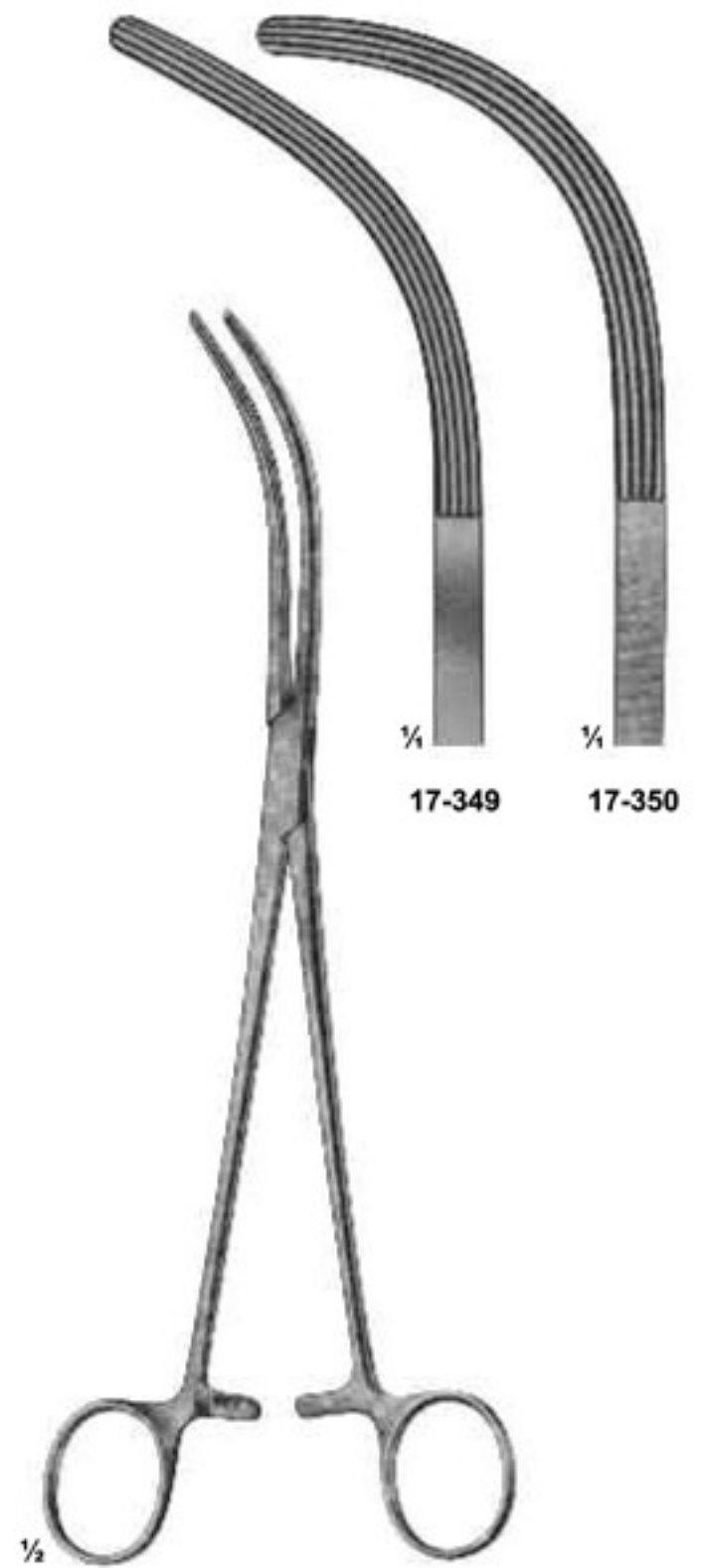

17-349 - 350
CRAFOORD
240 mm



17-351
PRICE THOMAS
225 mm

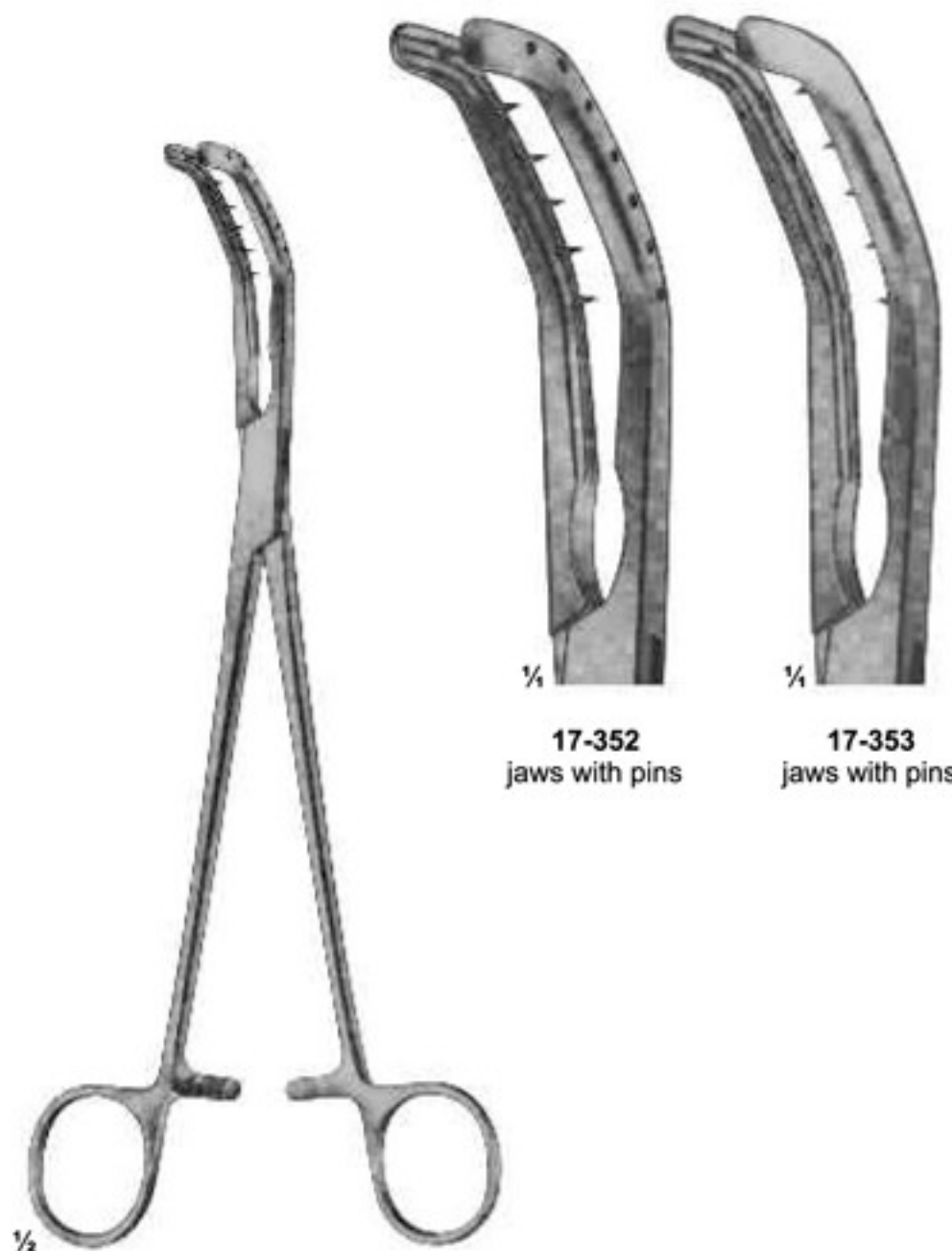

17-352
jaws with pins

17-353
jaws with pins

17-352 - 353
PRICE THOMAS
225 mm



17-354
SCHUMACHER
Sternum shears
210 mm



17-355
LEBSCHKE
Sternum chisel
200 mm



17-356
230 mm



17-357
COLLIN
195 mm



17-358
GLUCK
190 mm



17-359
GLUCK
190 mm



17-360
BRUNNER
Universal Pattern
340 mm



17-361
GIERTZ-STILLE
250 mm

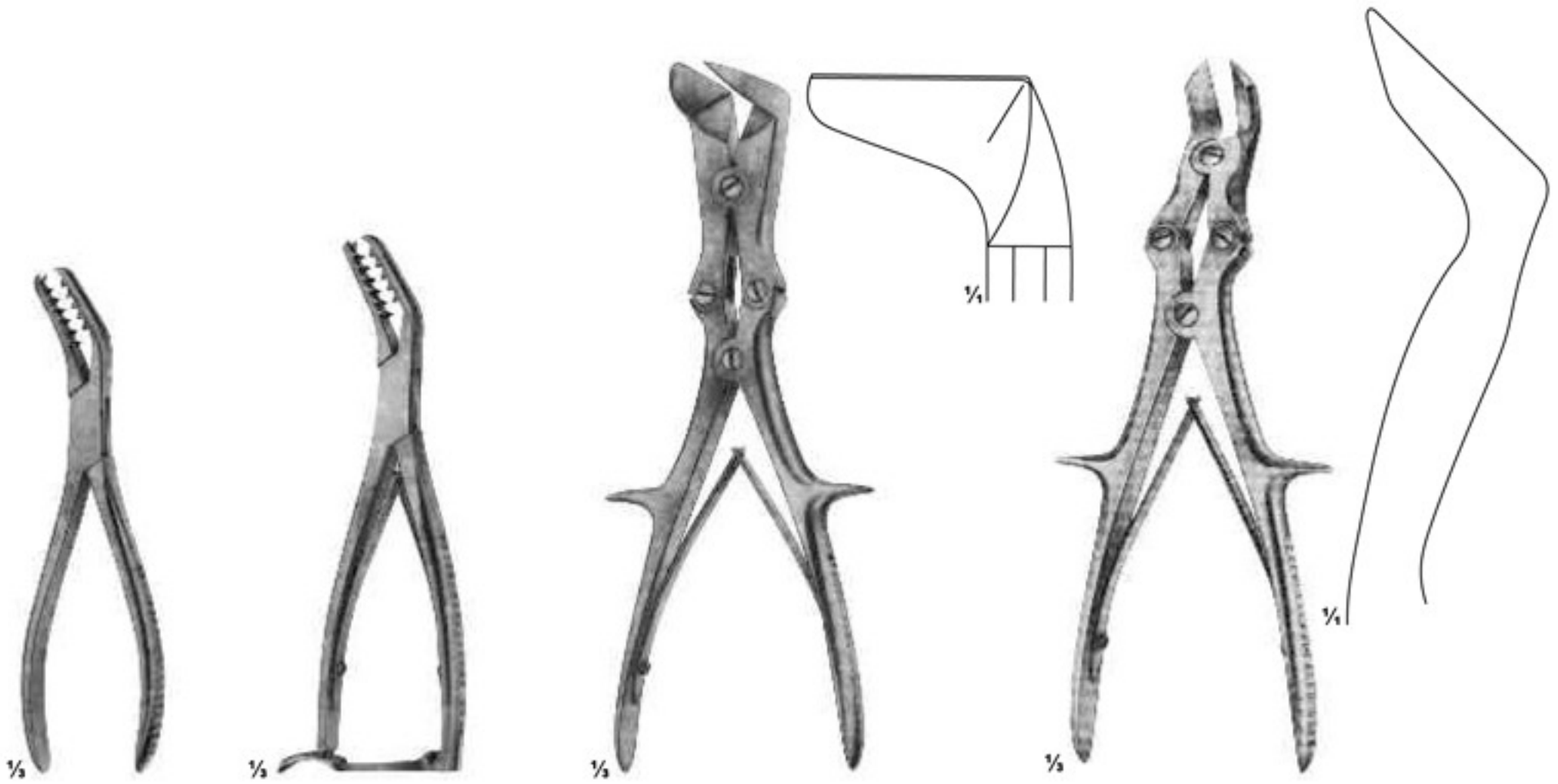

17-362
SEMB
Rib-and Bone
Holding forceps
190 mm

17-363
SEMB
Rib-and Bone
Holding forceps
190 mm

17-364
LISTON-STILLE
265 mm

17-365
LISTON-KEY-HORSLEY
255 mm

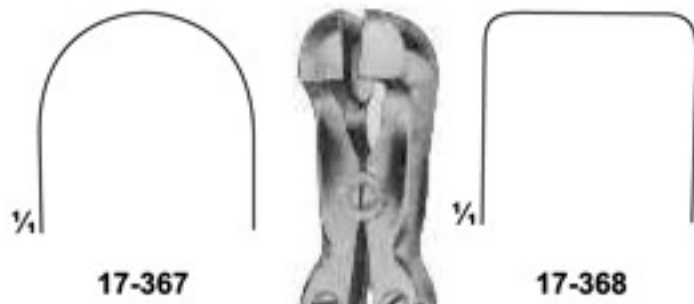

17-367

17-368

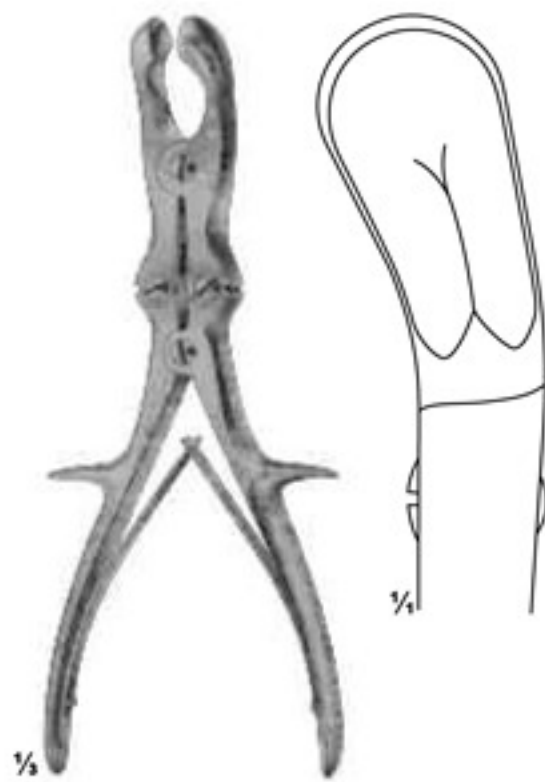

17-366
SEME
Rib Rongeur to shorten
the rib stumps
240 mm



17-367-368
SAUERDRUCH-CORYLLOS
Rib rongeurs to shortn
the rib stubes
310 mm

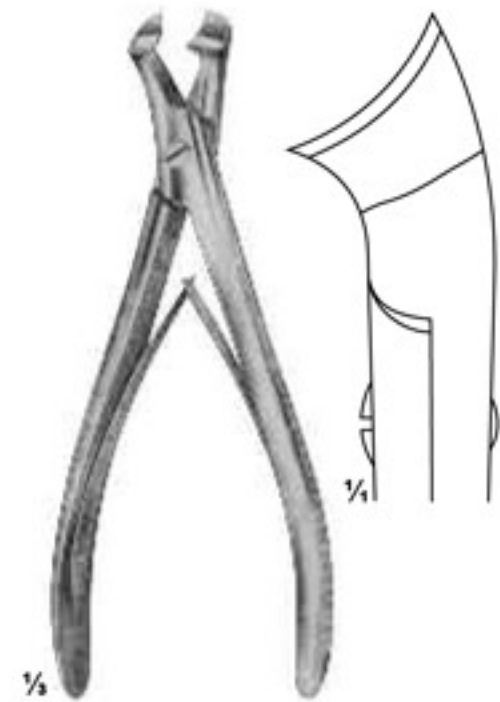

17-369
MARKWALDER
Rib Rongeur to Round
the rib stumps
190 mm

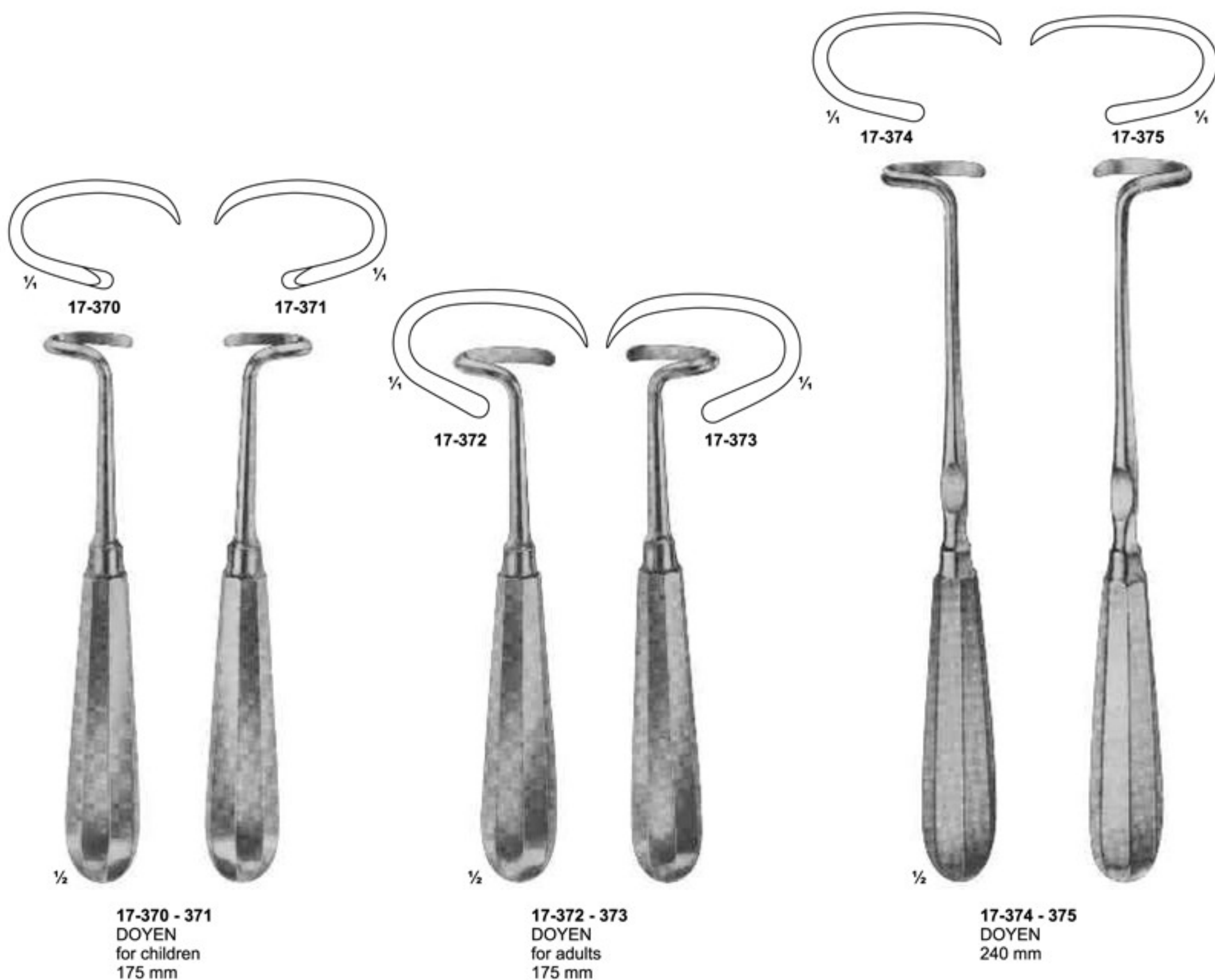



1/2
17-376 - 380
SEMB
230 mm

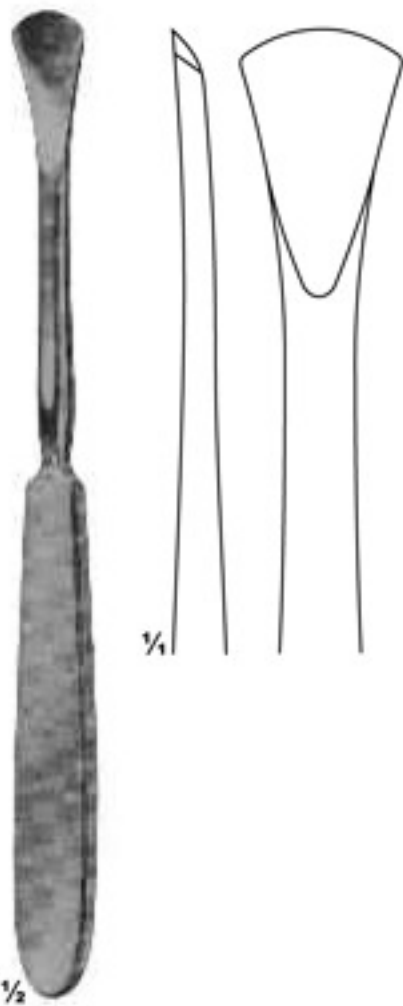
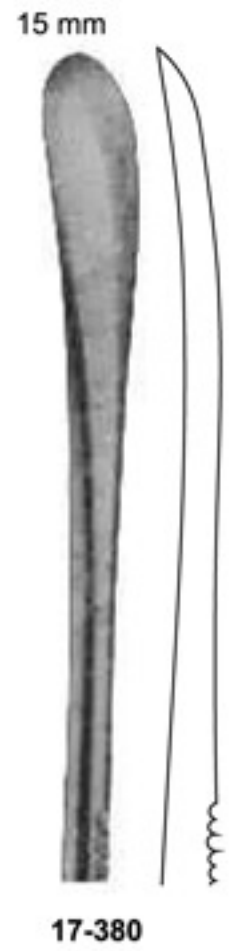
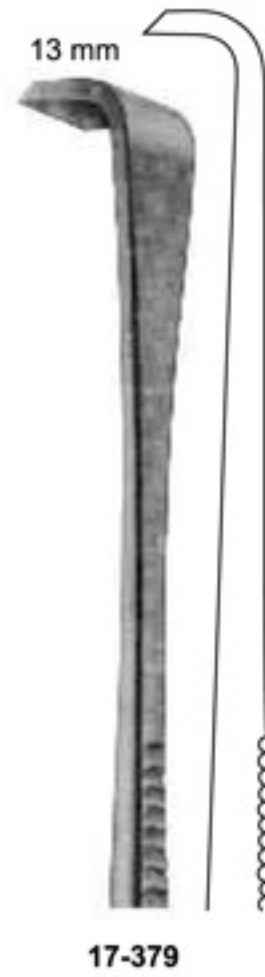
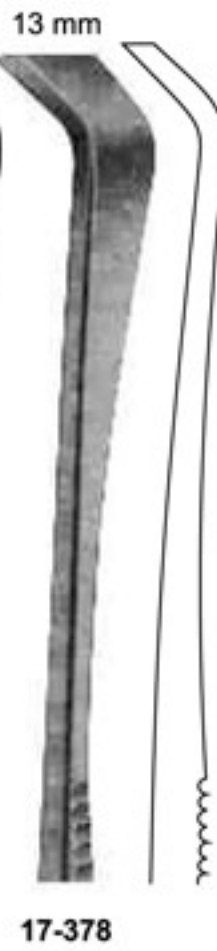
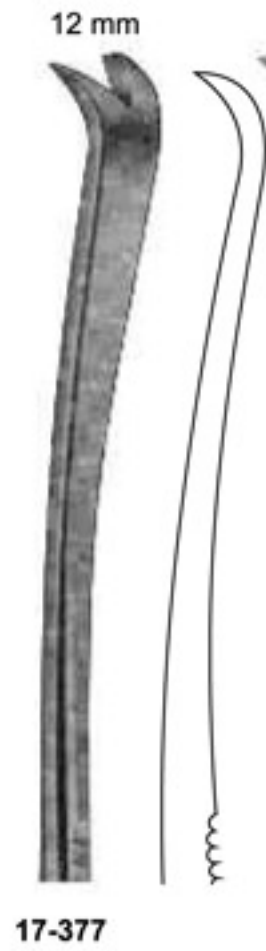

17-381
LANGENBECK
190 mm

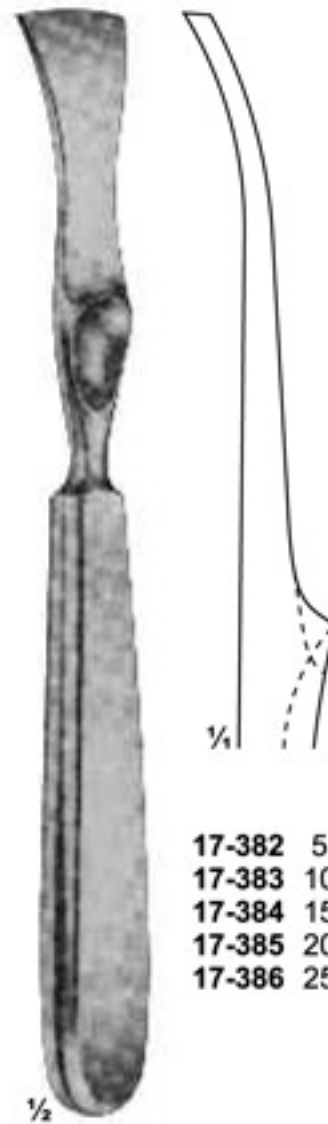

17-382 5 mm
17-383 10 mm
17-384 15 mm
17-385 20 mm
17-386 25 mm

17-382 - 386
LAMBOTTE
215 mm

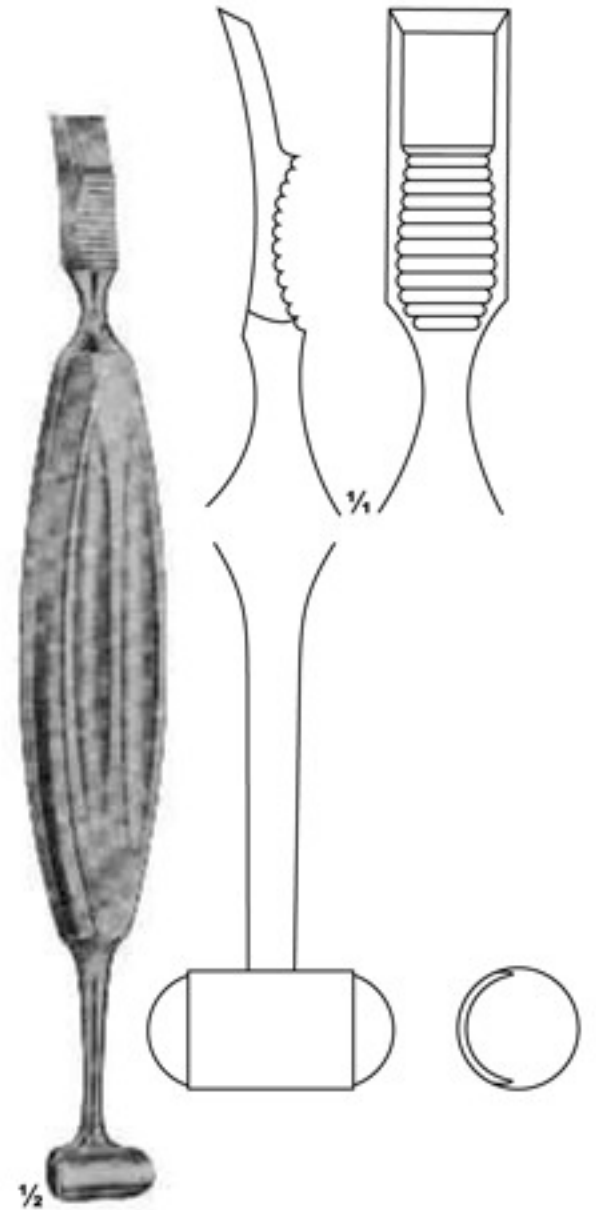

17-387
ALEXANDER
210 mm

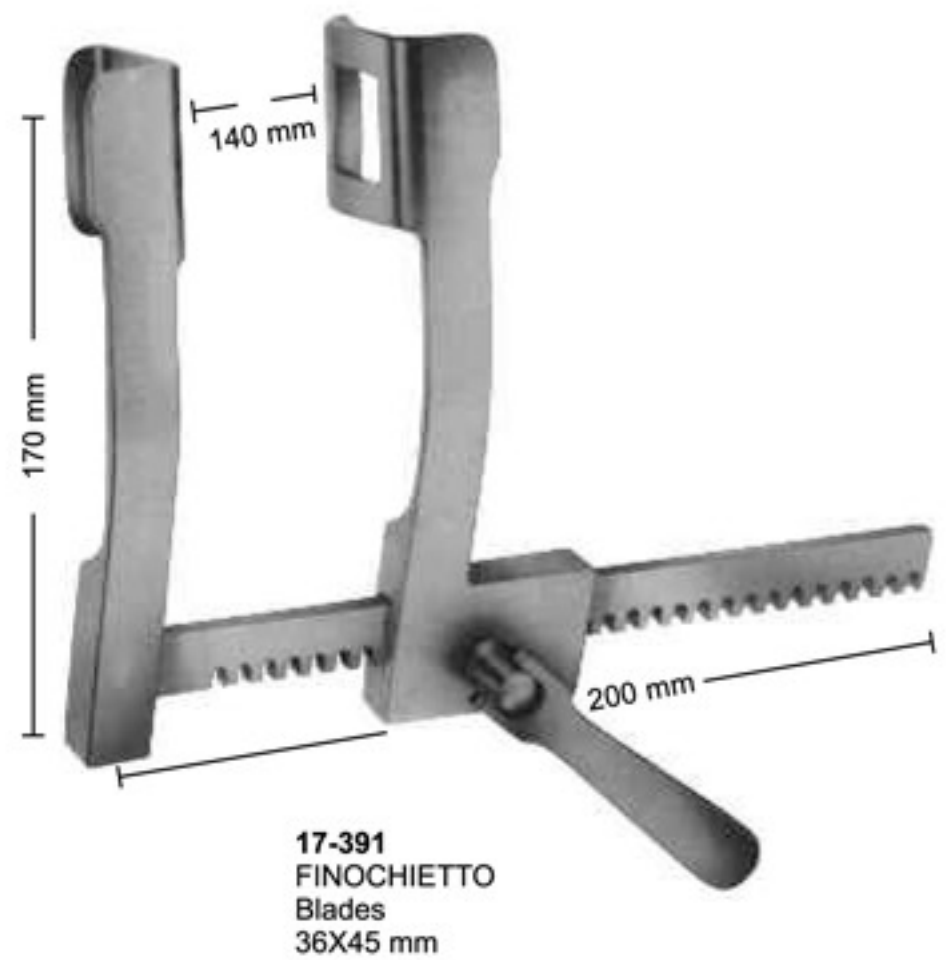
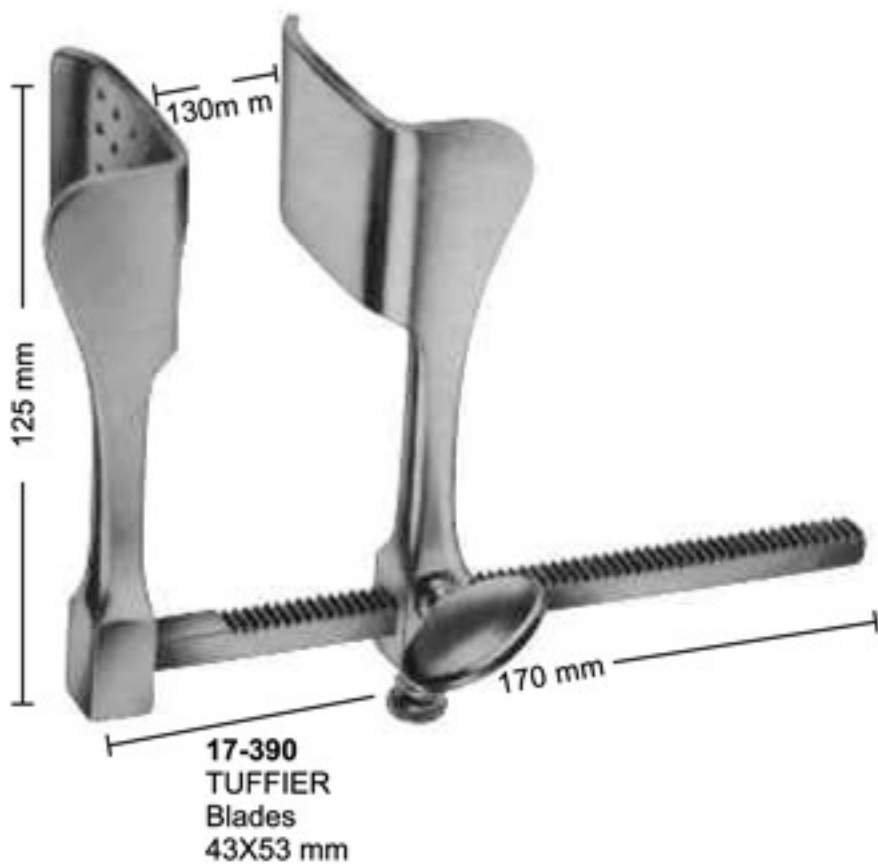
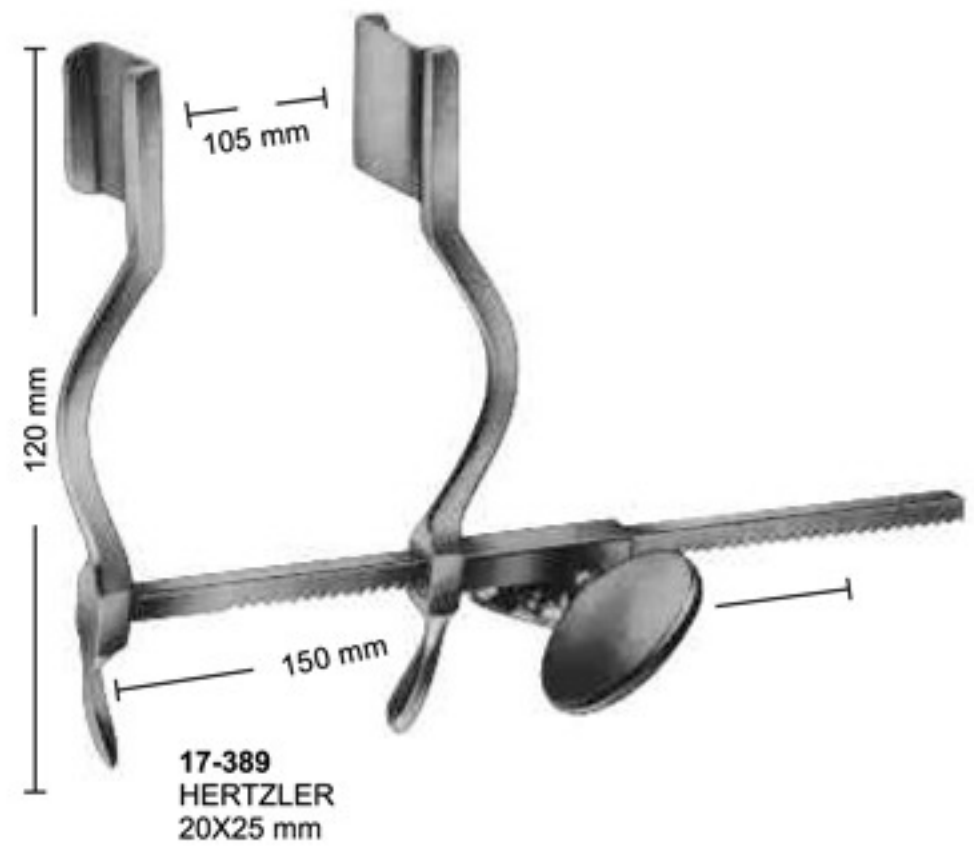
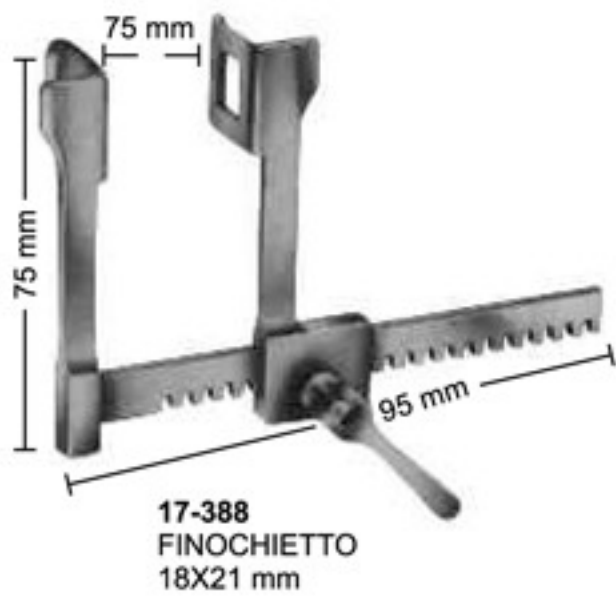

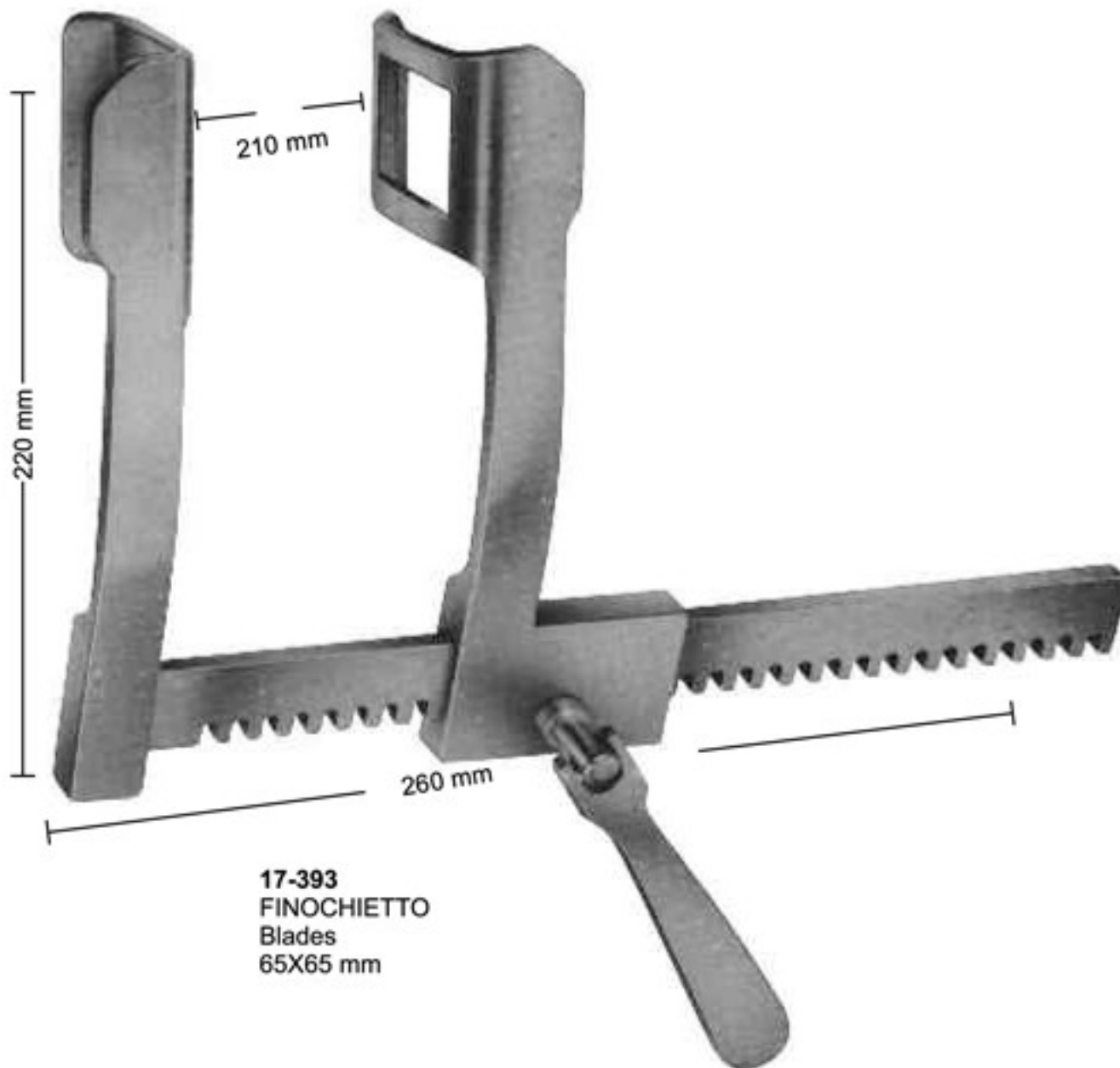
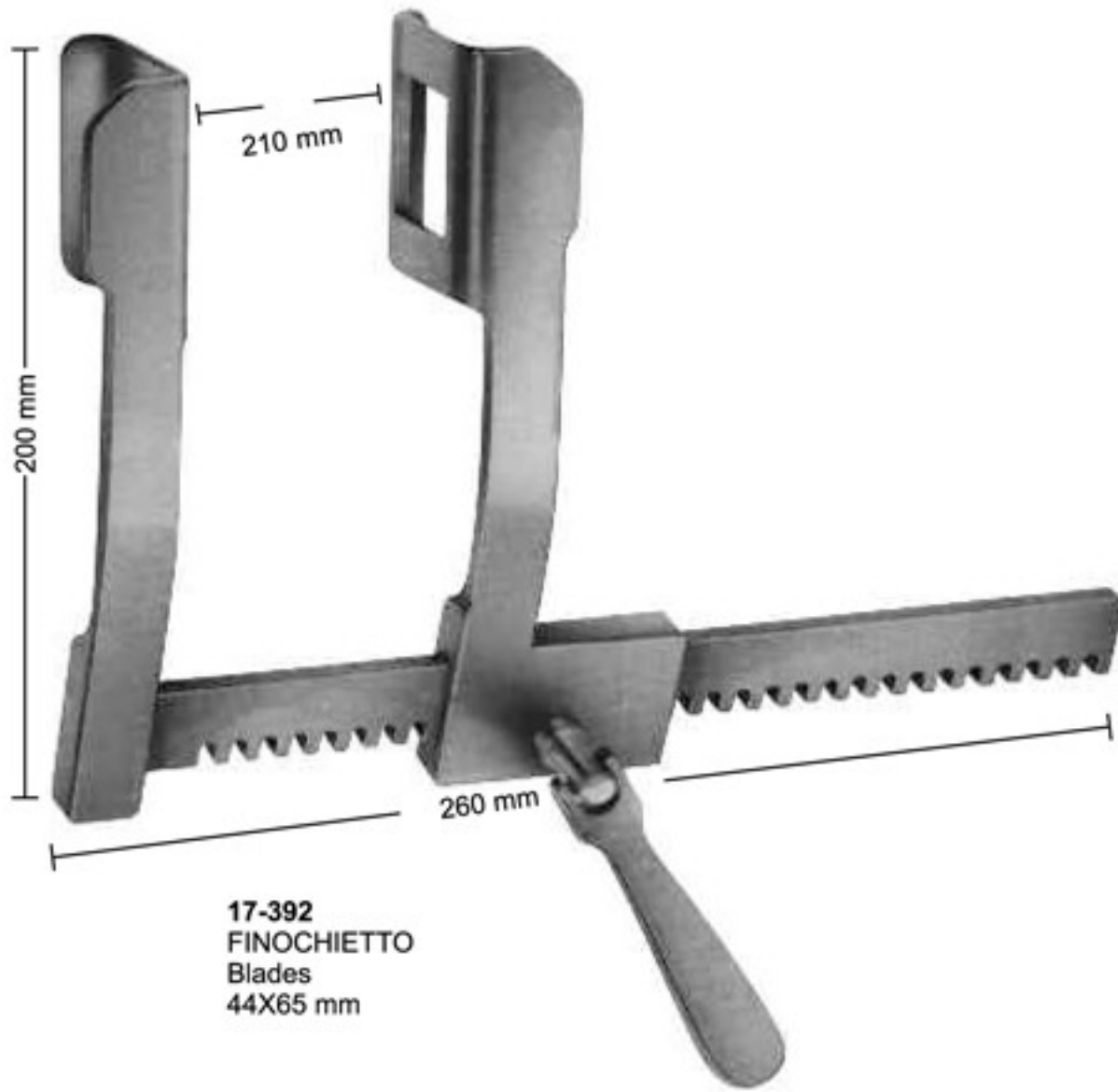

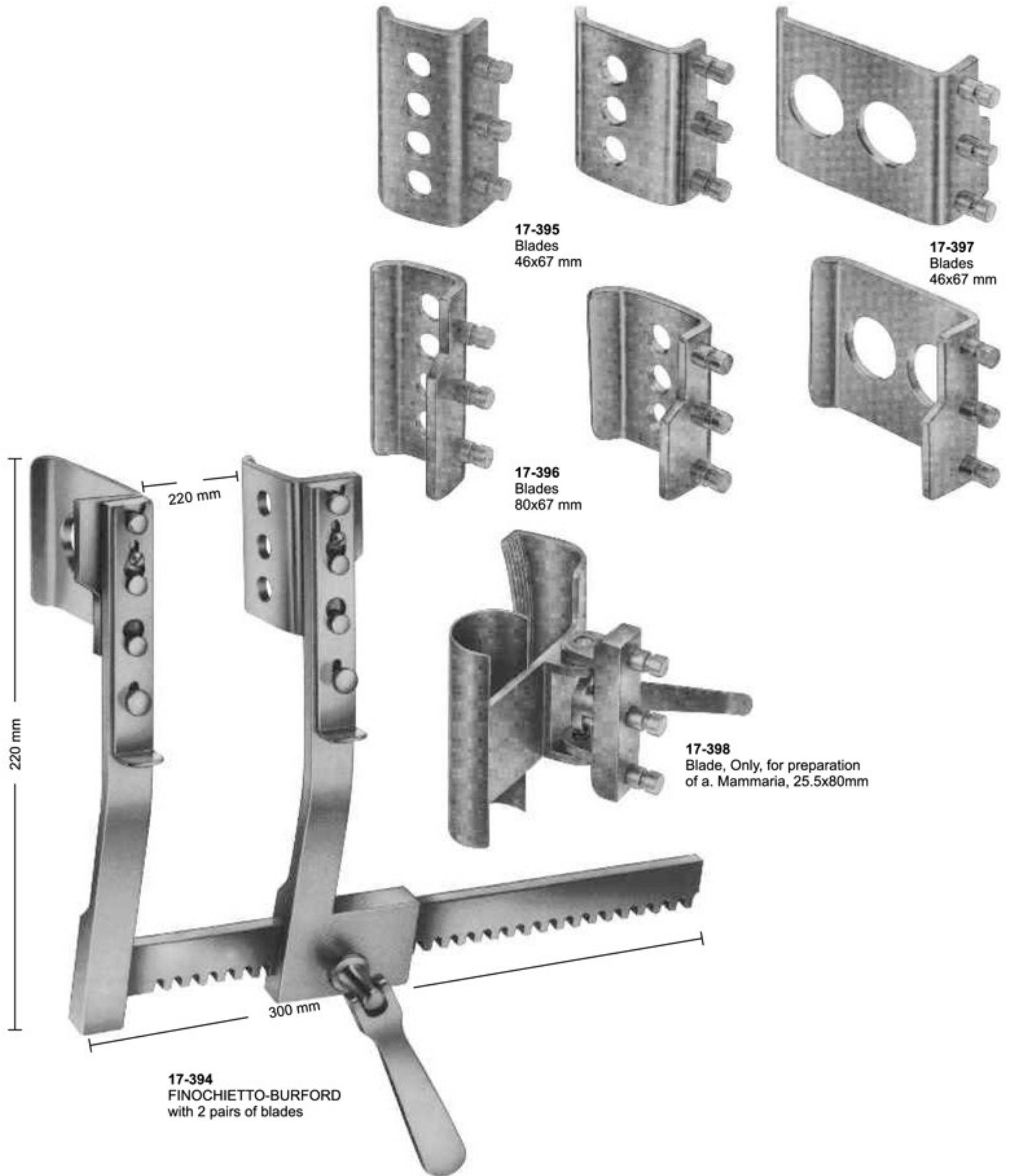

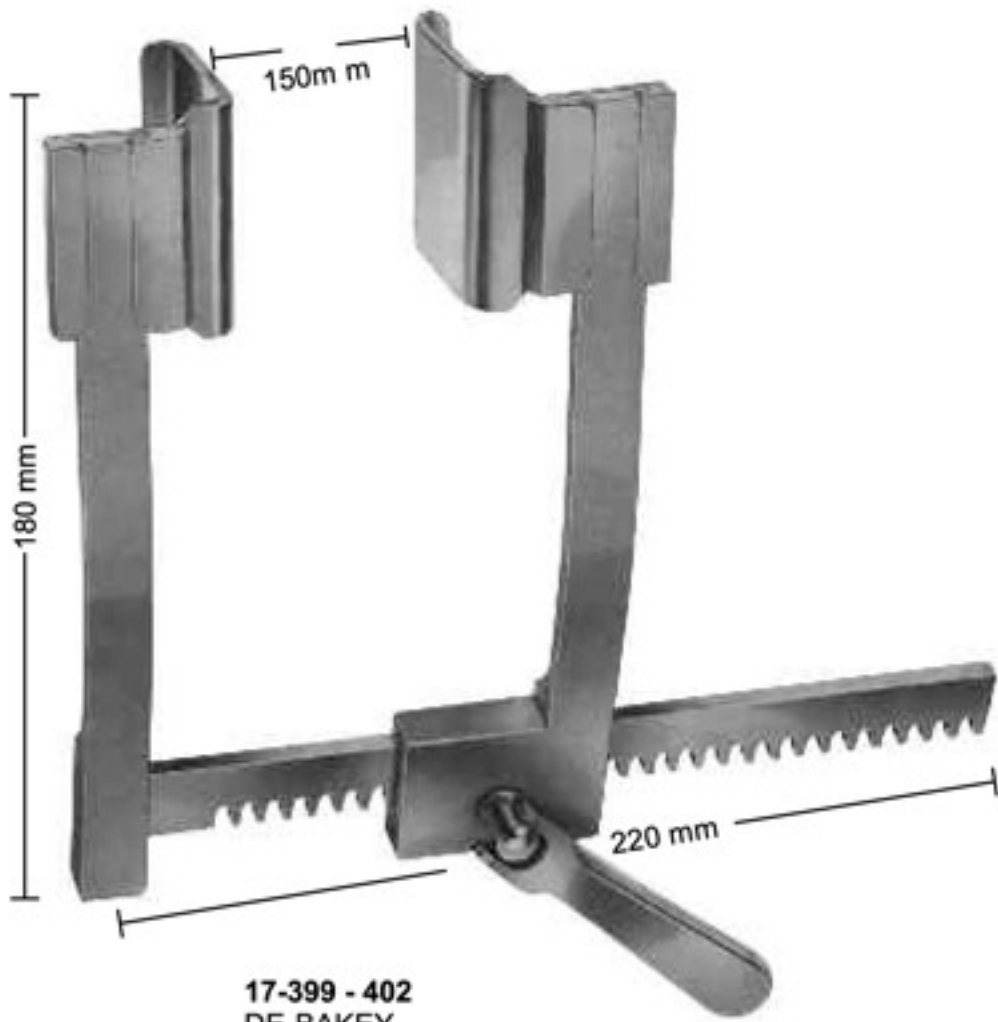

17-399 - 402
DE-BAKEY
with 3 pairs of blades

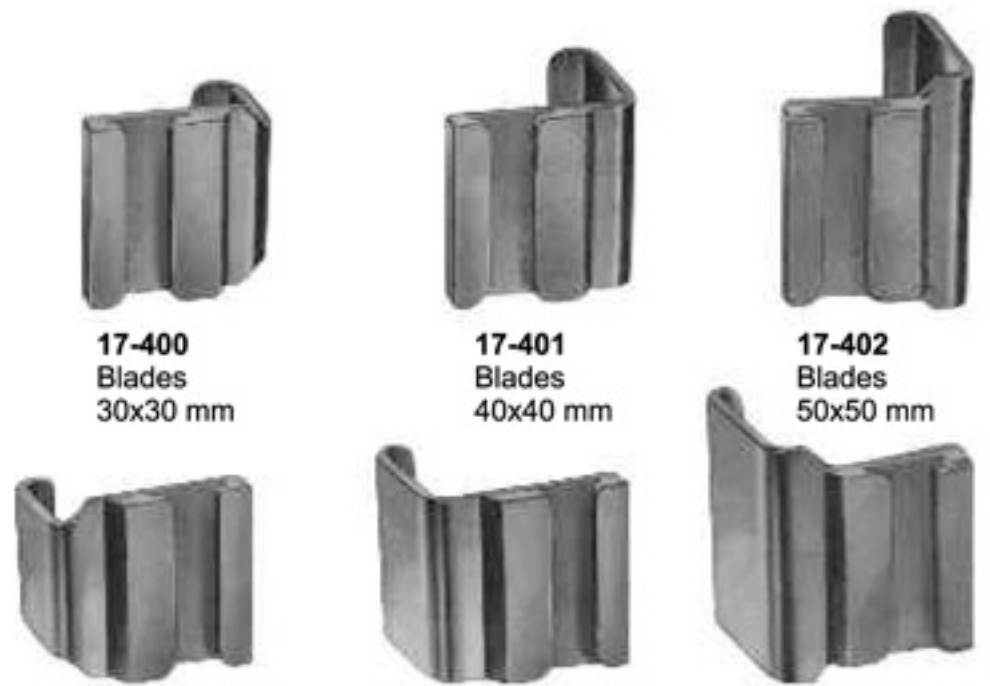

17-400
Blades
30x30 mm

17-401
Blades
40x40 mm

17-402
Blades
50x50 mm

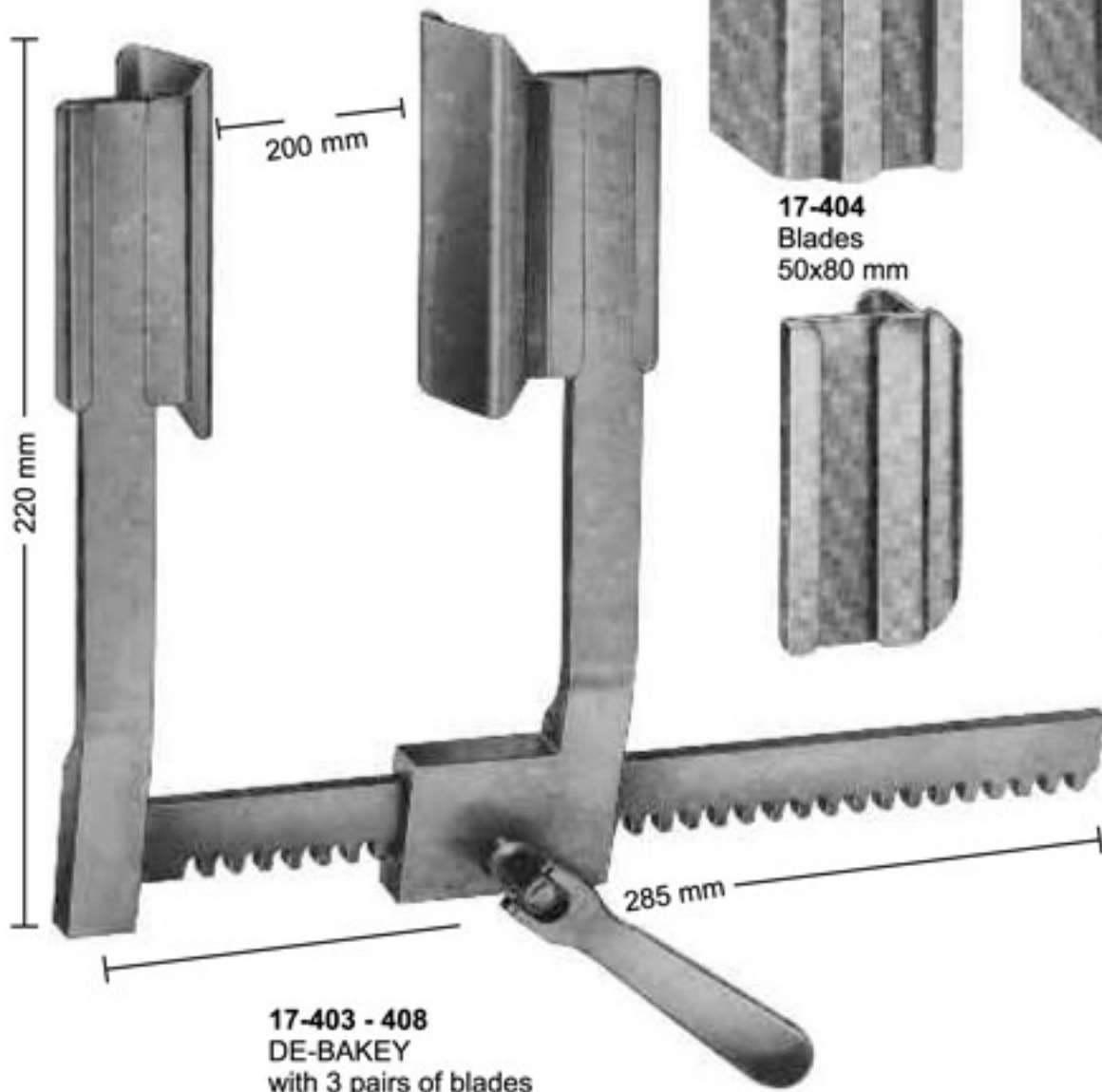

17-403 - 408
DE-BAKEY
with 3 pairs of blades

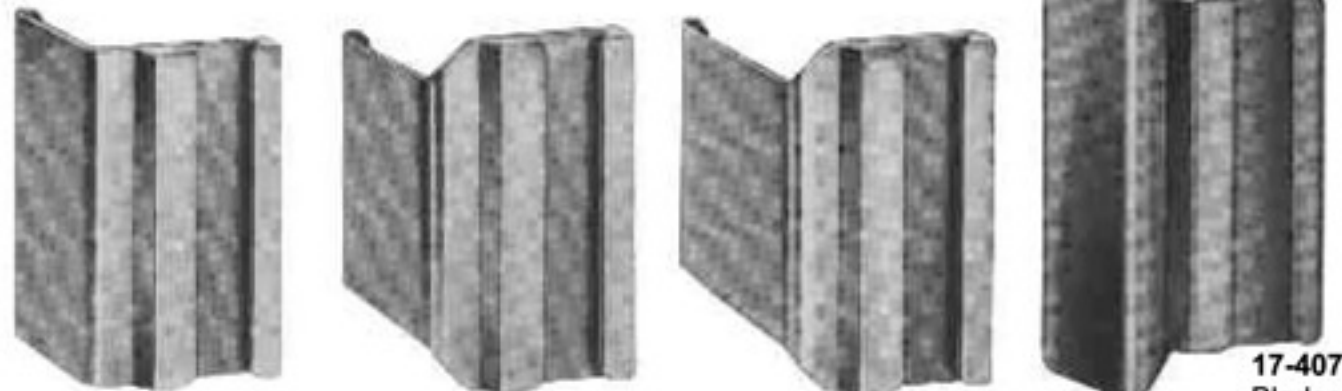

17-404
Blades
50x80 mm

17-405
Blades
80x60 mm

17-406
Blades
50x80 mm

17-407
Blades
40x100 mm

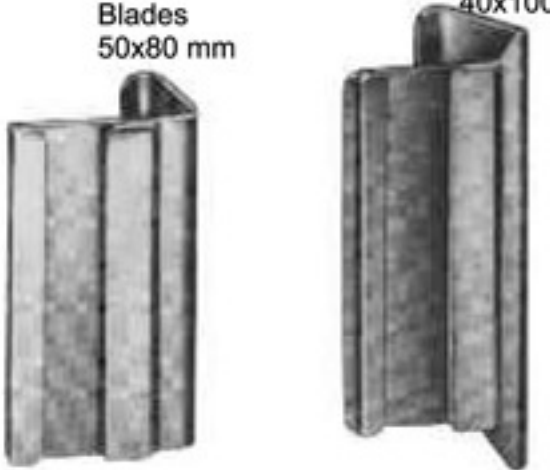

17-408
Sternotomy Blades
50x660 mm

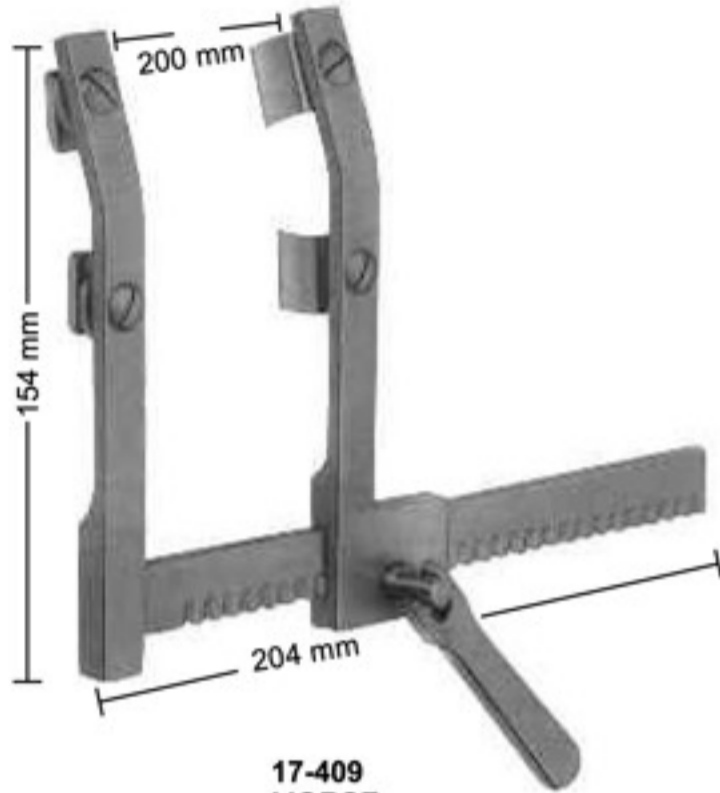

17-409
MORSE
 Sternotomy spreader
 for children, with moveable
 double, each blade
 12x20 mm

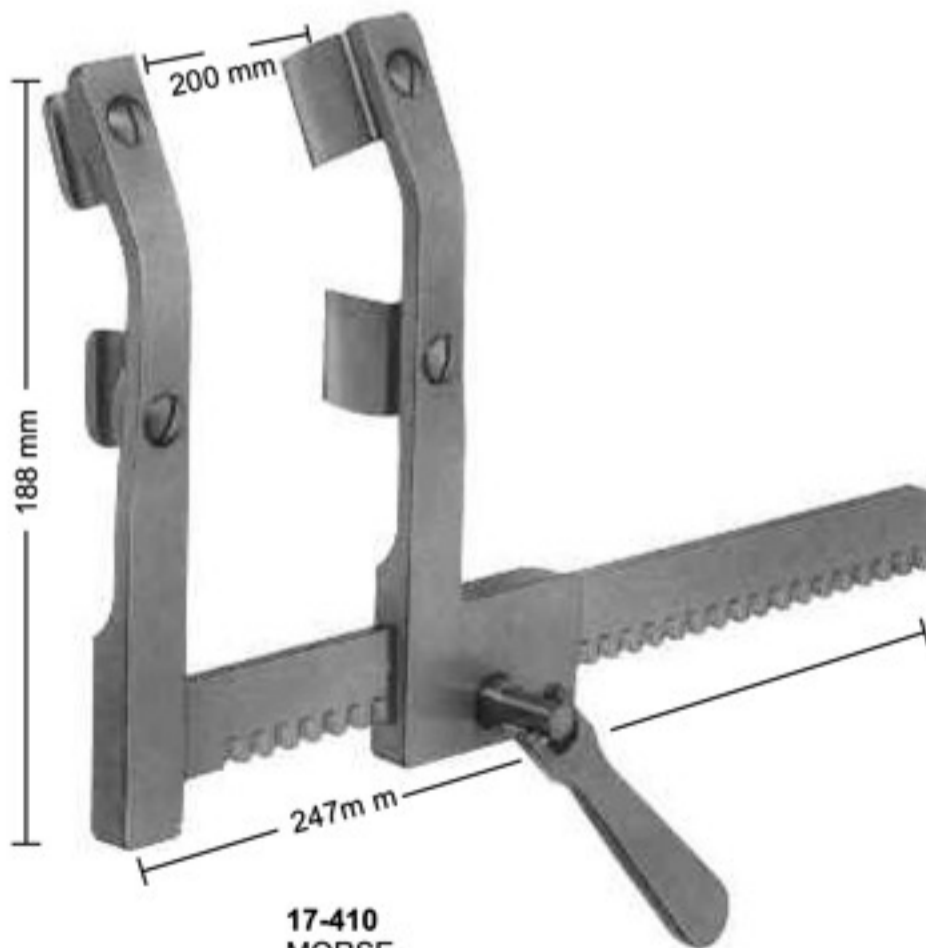

17-410
MORSE
 Sternotomy spreader
 for adults, with moveable
 double, each blade
 19x19 mm

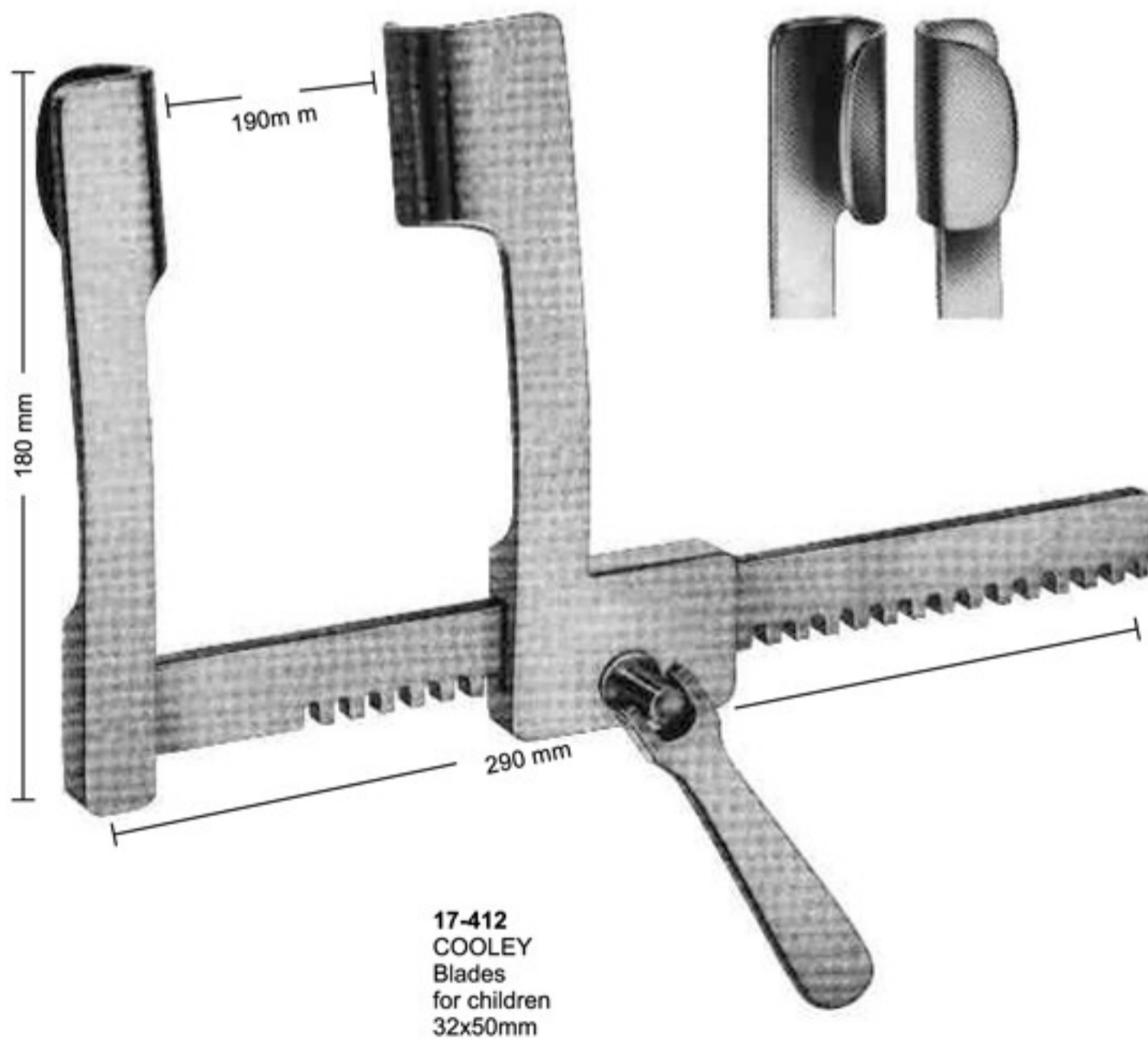
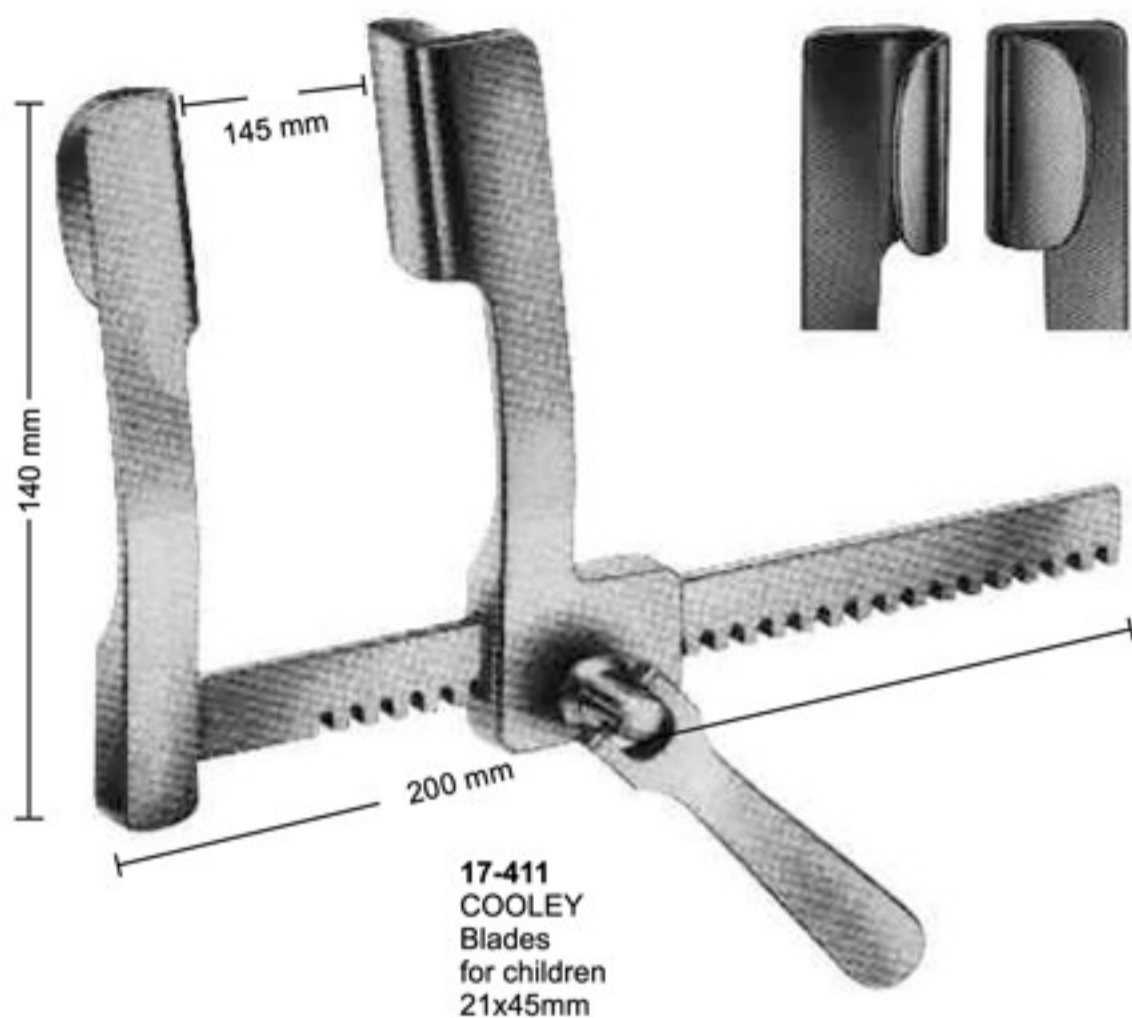



17-414
Blades
75x75 mm



17-415
Blades
42x65 mm

Blades with Ball Snap System
Delivery: in Pairs

- 17-413 - 415**
Thoraxsperrer (Mercedes-Sperrer)
complete consisting of:
17-413 Retractor only
17-414 1 Pair of blades 42x65 mm
17-415 1 Pair of blades 75x75 mm



17-416
SELLORS
 Rib spreader and contractor
 with swivel blades
 200 mm



17-417
BAILEY
 150 mm

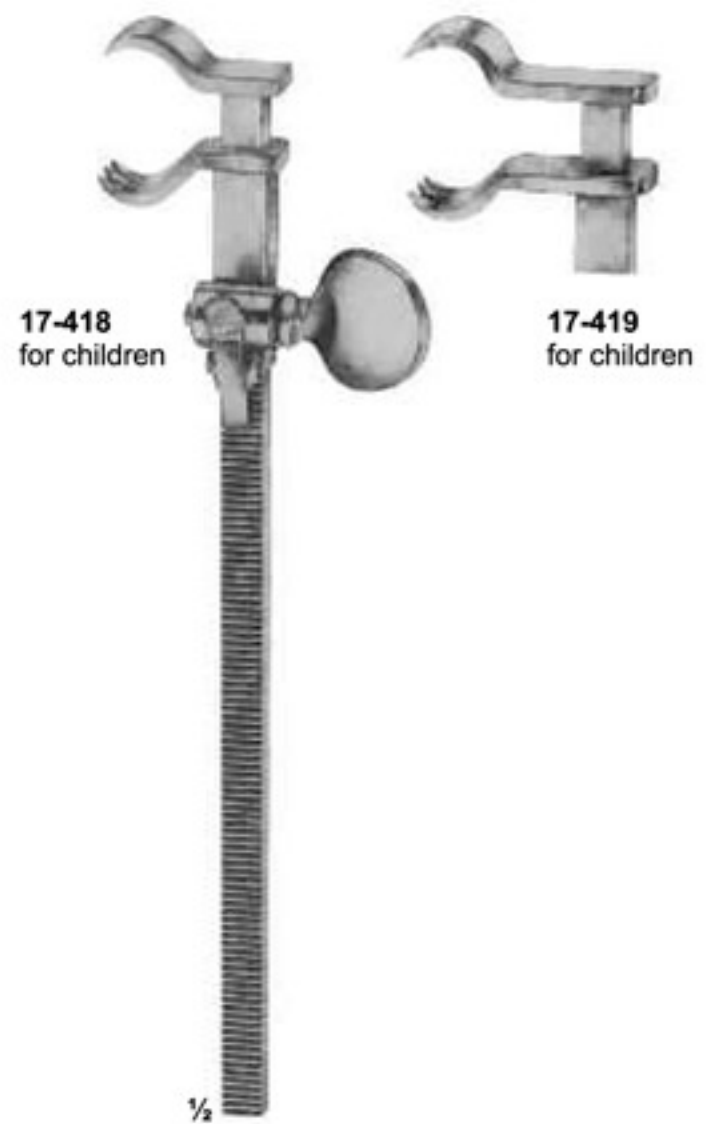

17-418
 for children

17-419
 for children

17-418 - 419
BAILEY
 200 mm

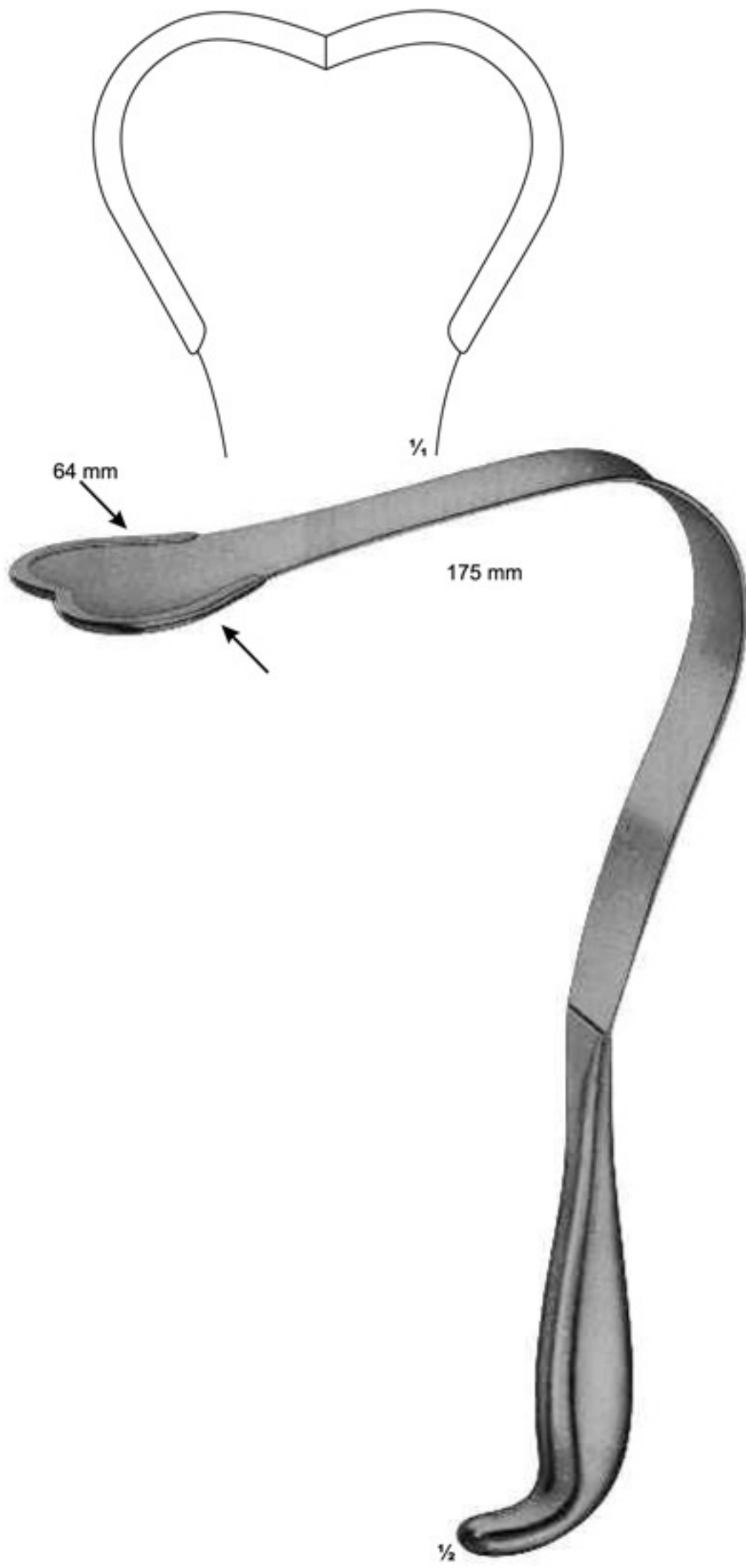

17-420
HARRINGTON-PEMBERTON
federnd/flexible
295 mm

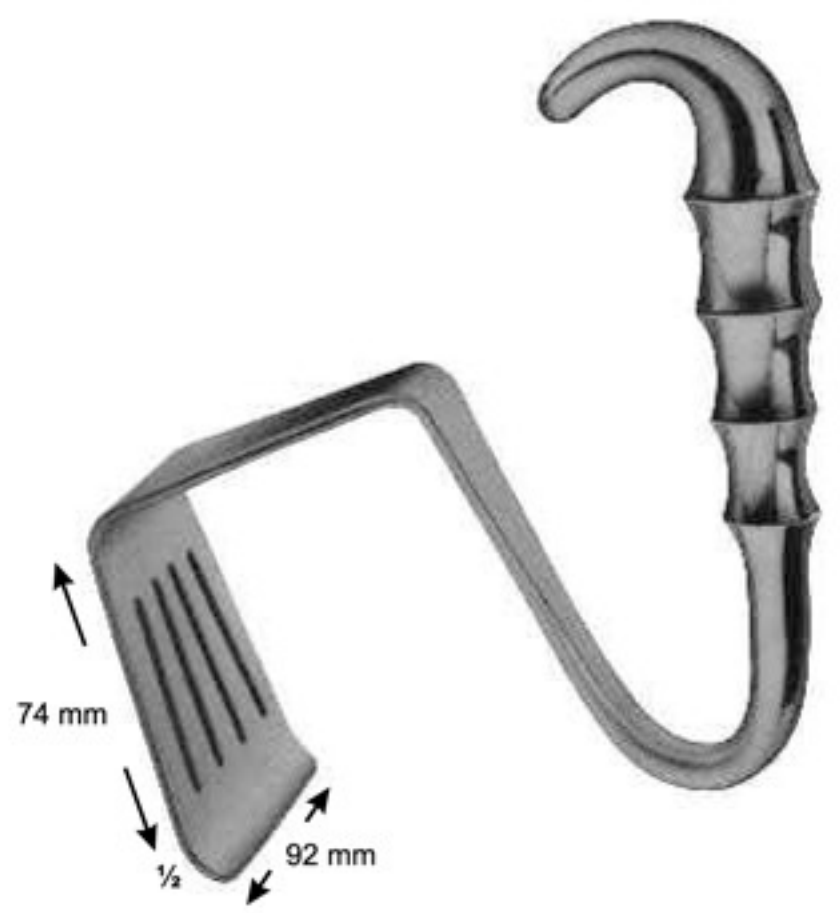

17-421
DAVIDSON
Scalpel haken



17-422
ALLISON
255 mm



17-423
ALLISON
320 mm



ϕ 6-10 mm
1/4

17-424
DE BAKEY
With central bore,
3.0mm diam.
with lateral slots
275 mm



ϕ 7-9 mm
1/2

17-425
YANKAUER
With central bore,
2.0mm diam.
285 mm

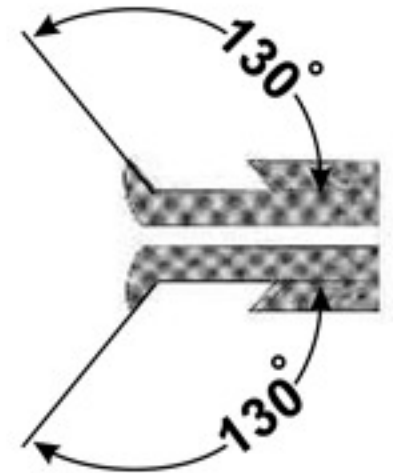
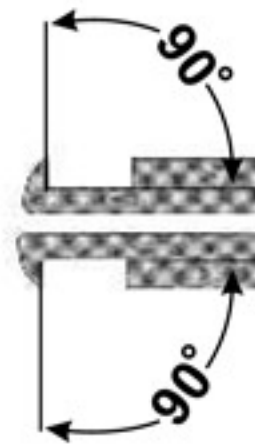
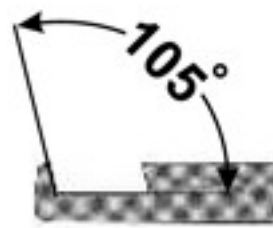

90° upwards cutting

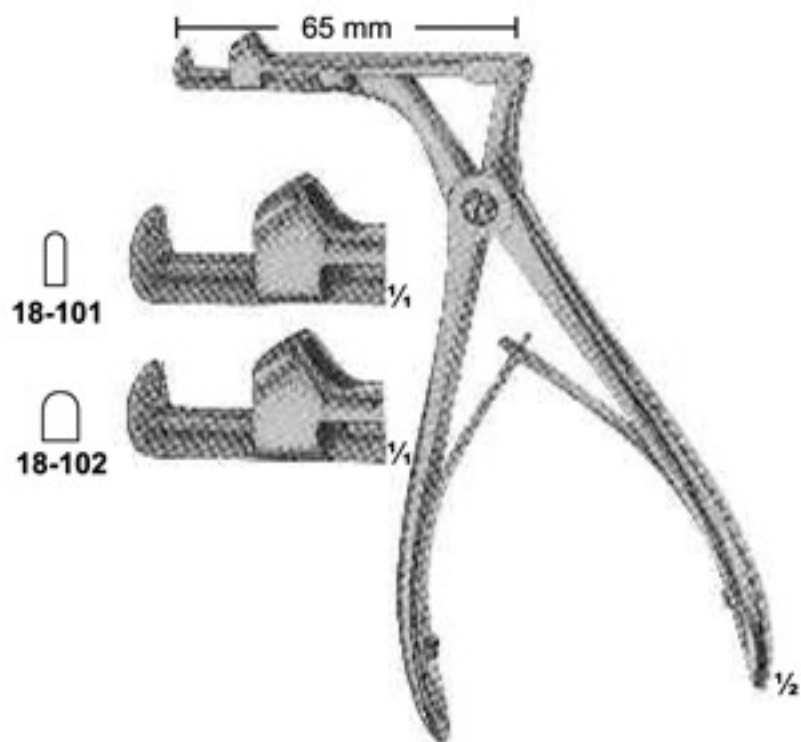

18-101 - 102
CITELLI
2 mm, 3,5 mm

90° upwards cutting

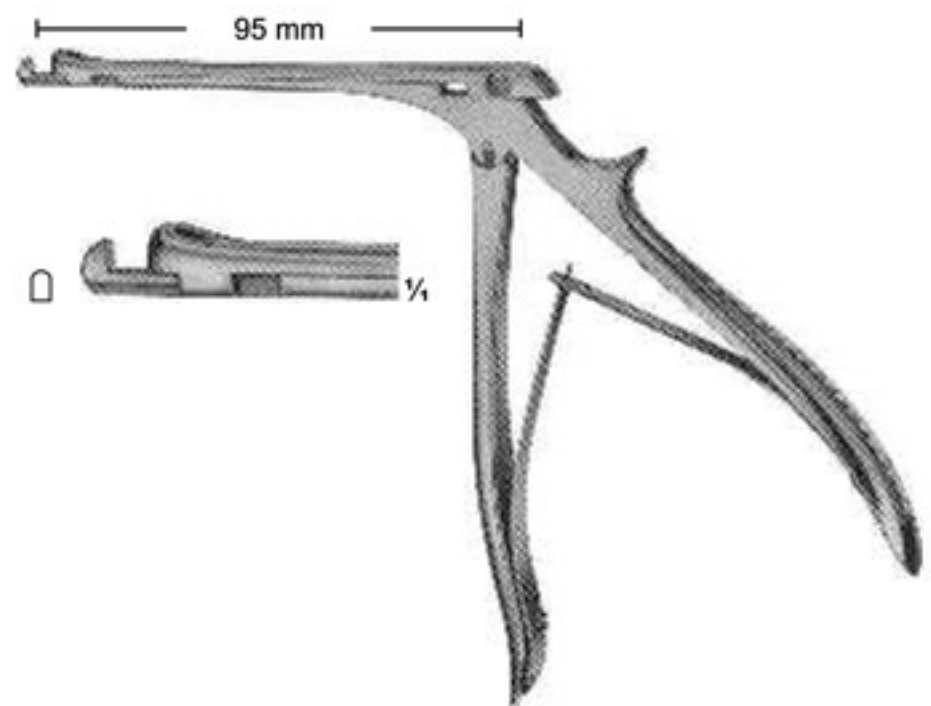

18-103
CITELLI- BEYER
1,8 mm

90° upwards cutting

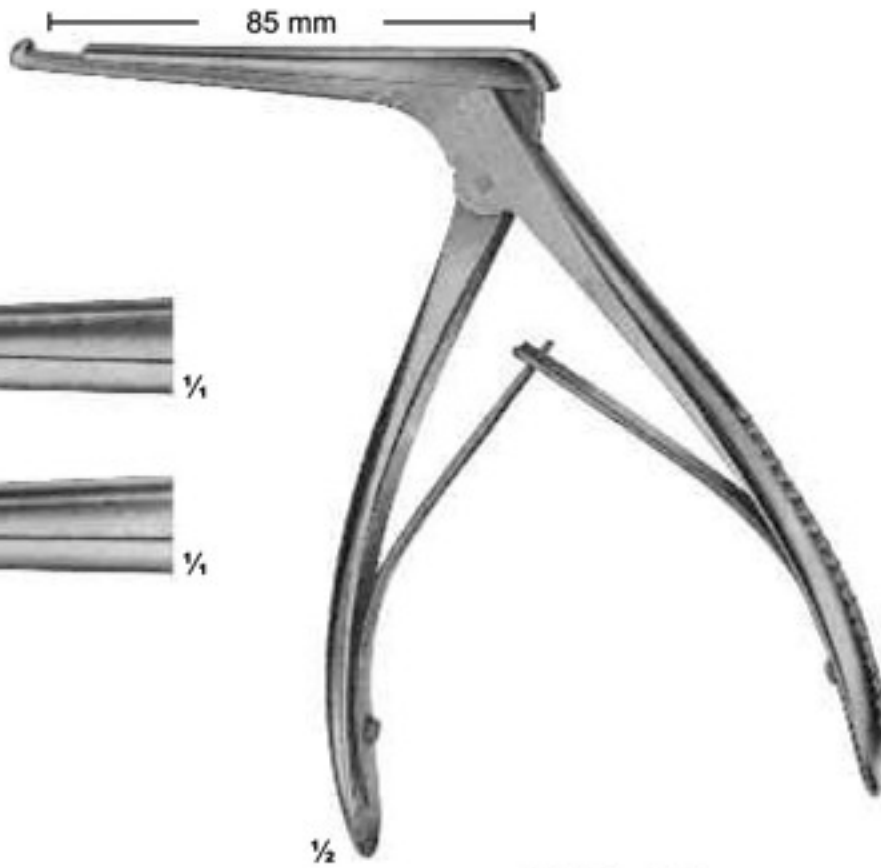

18-104
4 mm



18-105
5 mm



18-104 - 105
KERRISON

90° upwards cutting

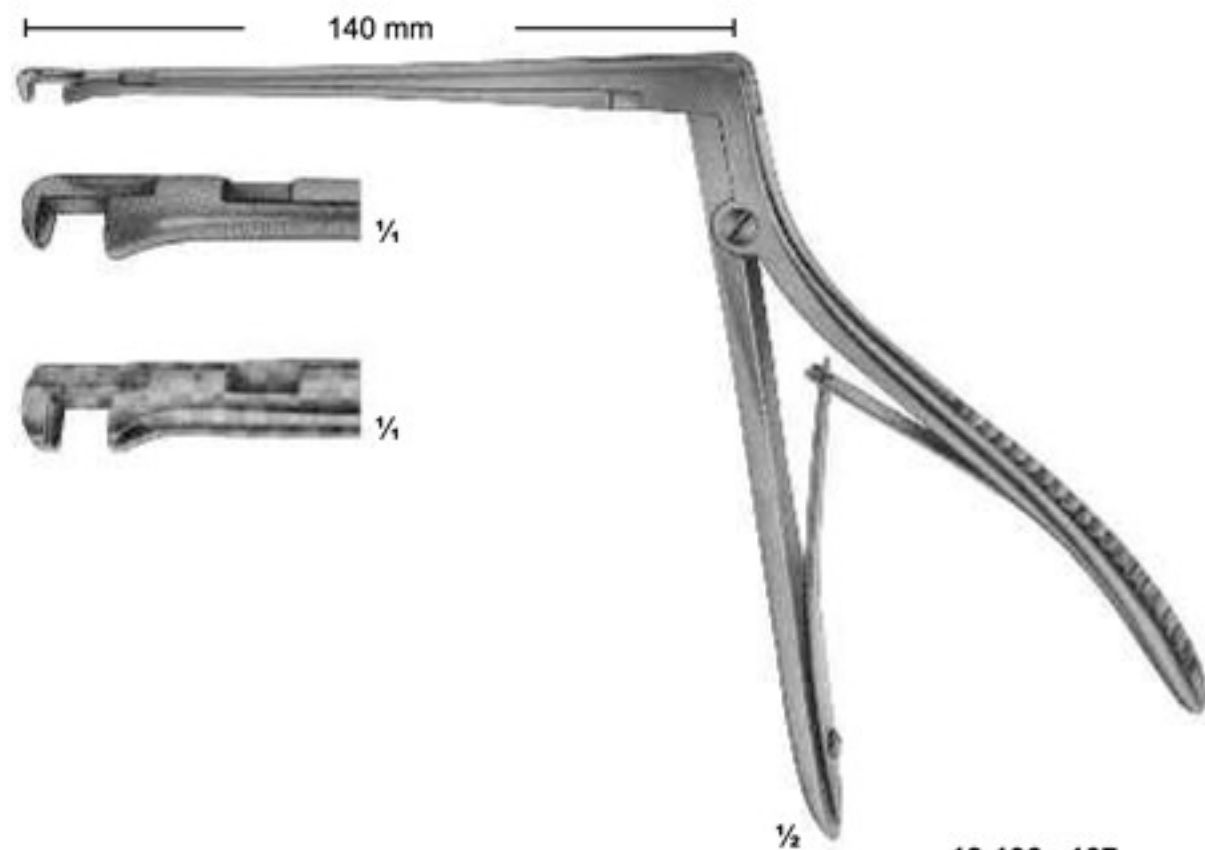

18-106
3,3 mm



18-107
4,0 mm



18-106 - 107
HAJEK-KOFLER

130°

upwards cutting

- 18-108
1 mm ◻
- 18-109
2 mm ◻
- 18-110
3 mm ◻
- 18-111
4 mm ◻
- 18-112
5 mm ◻

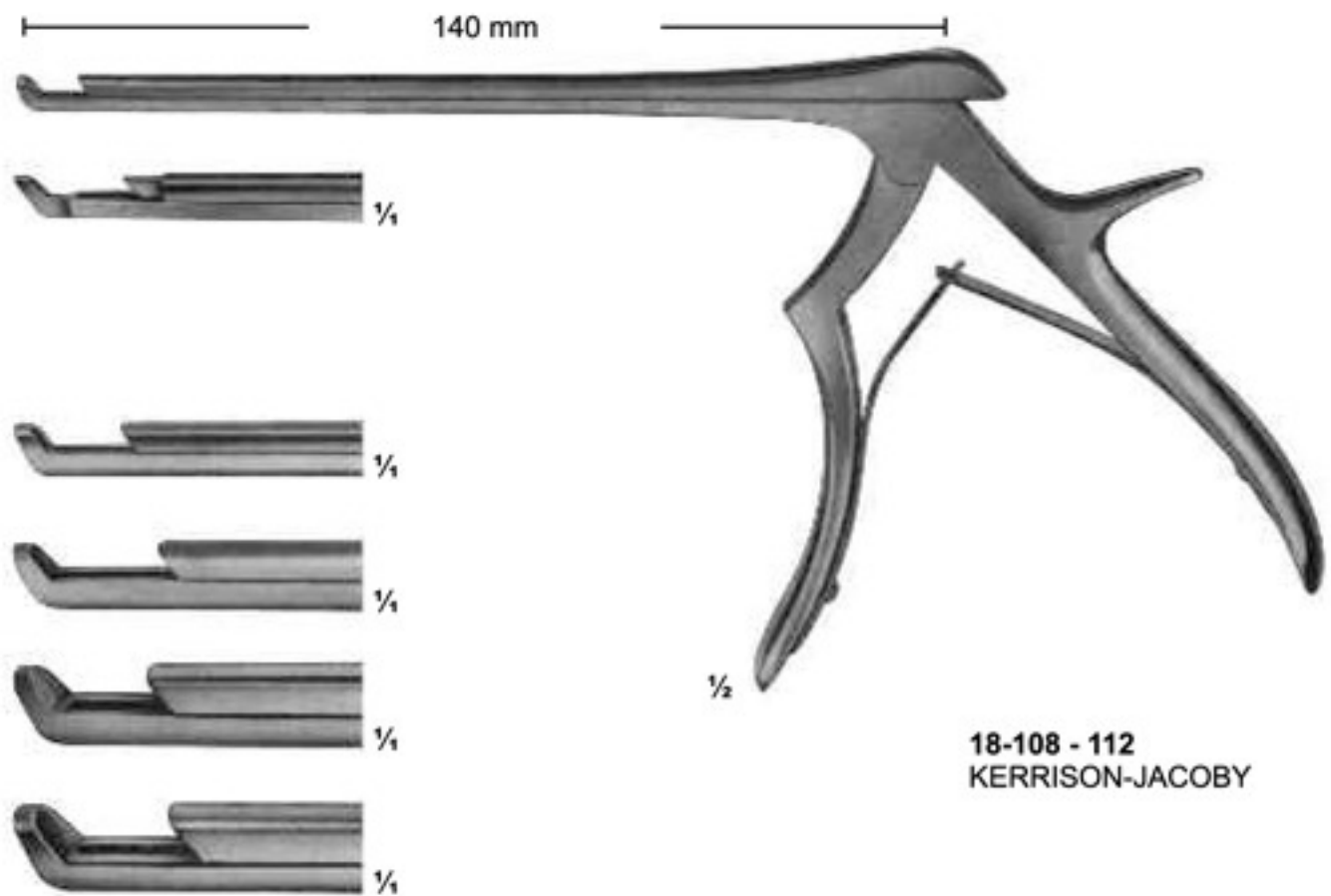

18-108 - 112
KERRISON-JACOBY

90°

upwards cutting

- 18-113
1 mm ◻
- 18-114
2 mm ◻
- FERRIS-SMITH-KERRISON
18-115
3 mm ◻
- 18-116
4 mm ◻
- 18-117
5 mm ◻

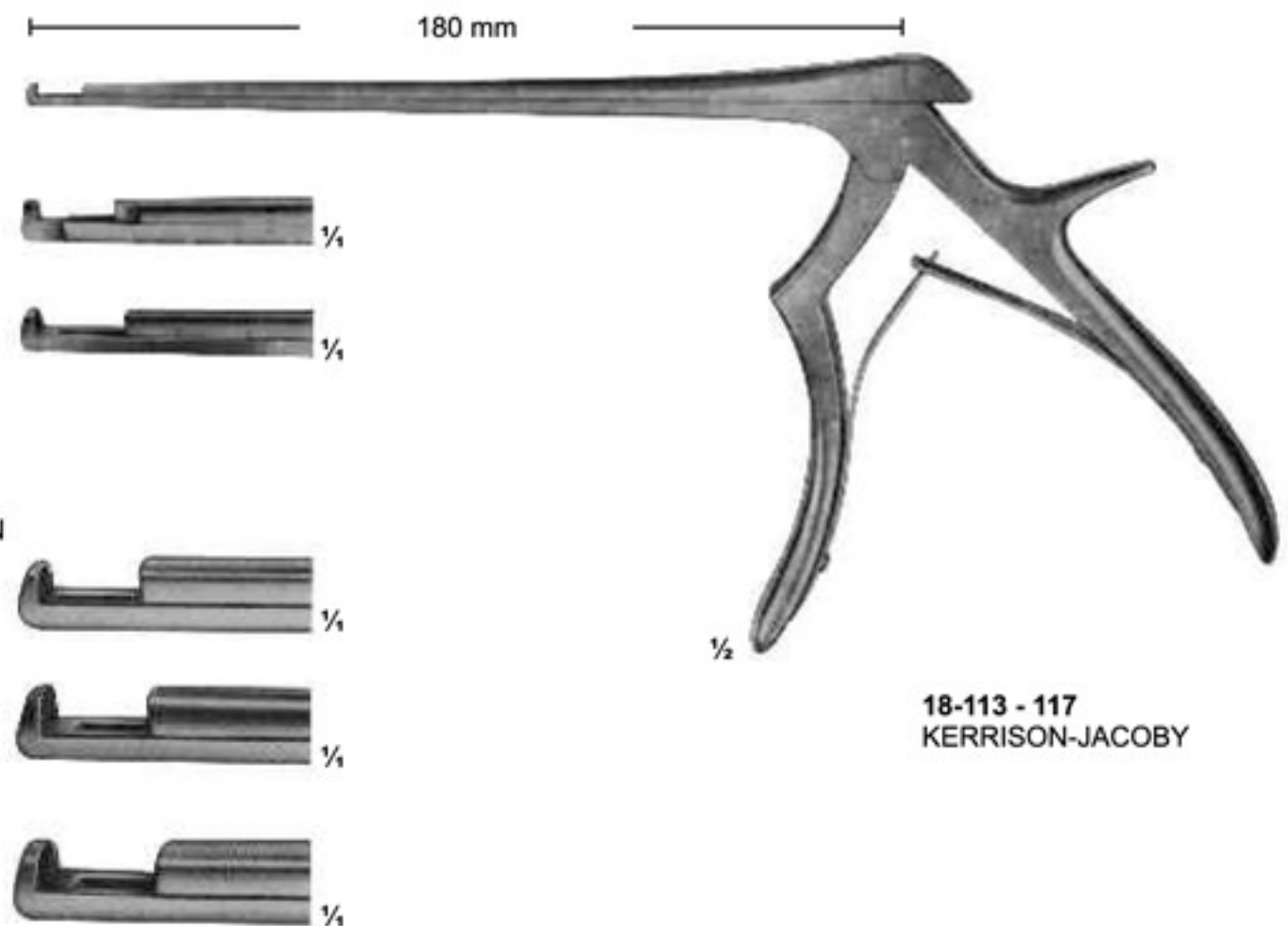

18-113 - 117
KERRISON-JACOBY

Angled positions for rongeurs

- 18-118**
3,0 mm
- 18-119**
3,6 mm
- 18-120**
4,2 mm
- 18-121**
4,8 mm
- 18-122**
5,8 mm

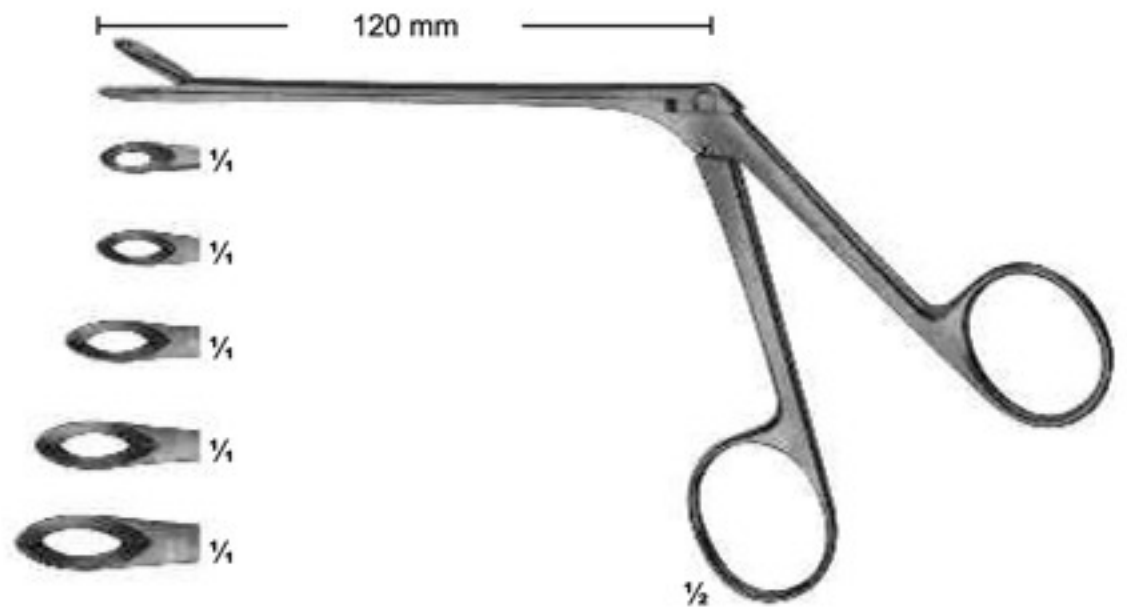

18-118 - 122
WEIL-BLAKESLEY

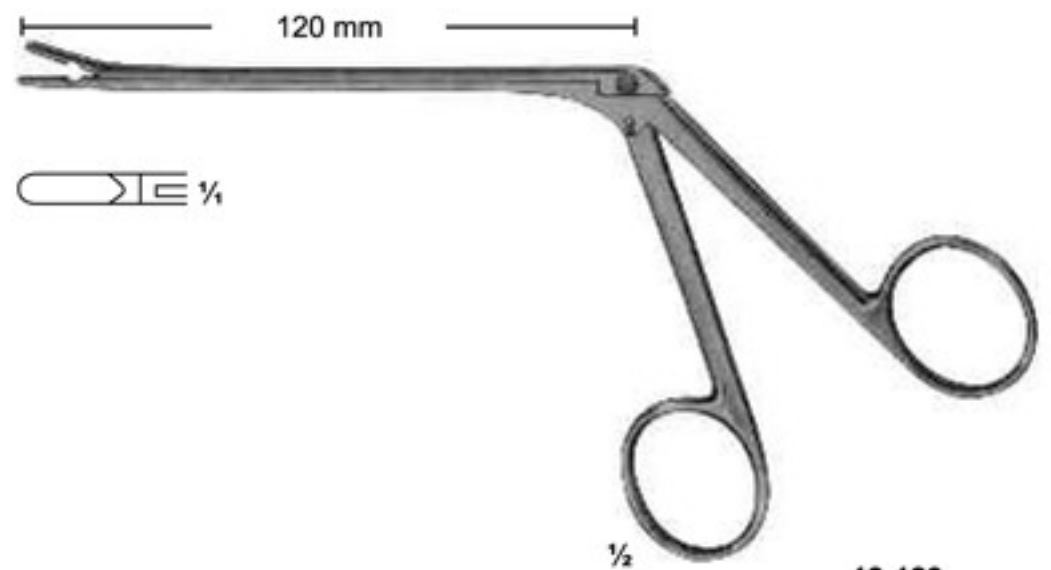

18-123
TAKAHASHI
3 mm

130°

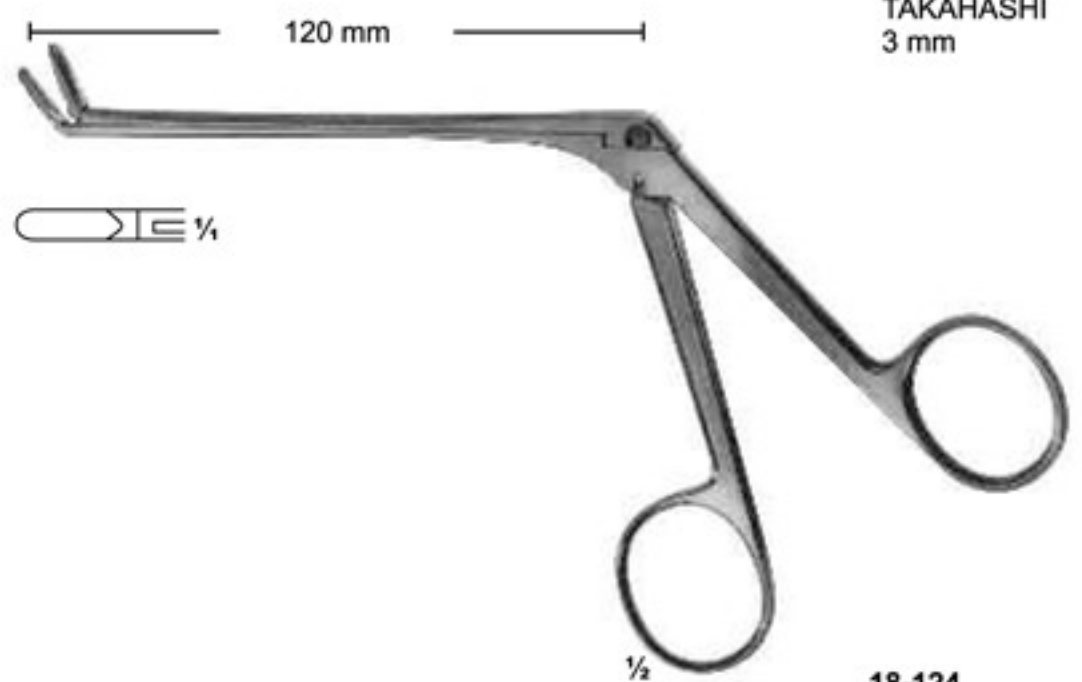

18-124
TAKAHASHI
3 mm

18-125
2 X 10 mm

18-126
3 X 10 mm

18-127
4 X 10 mm

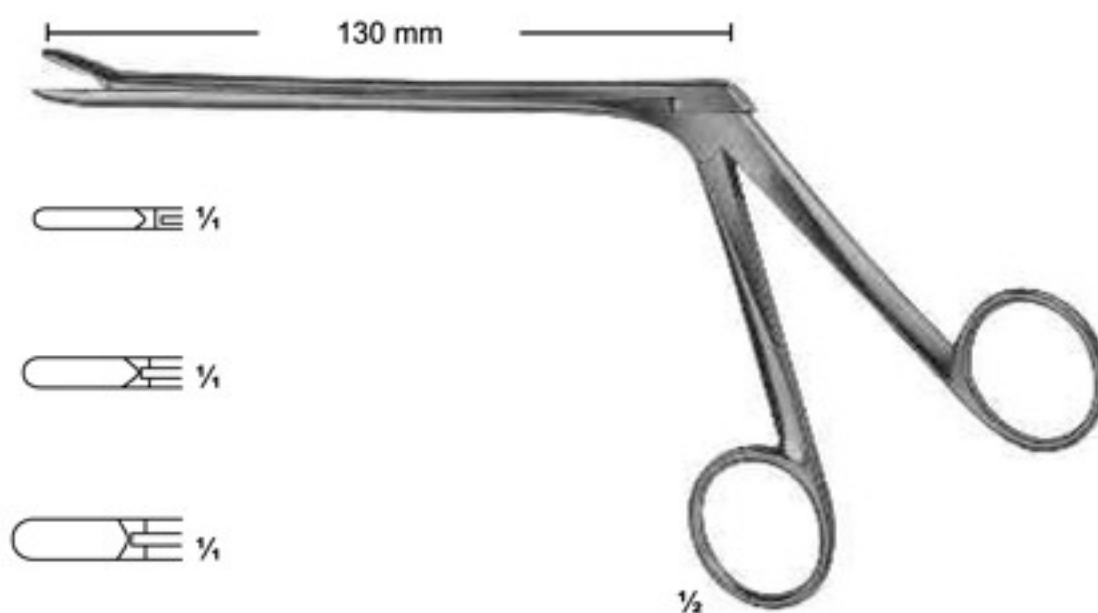

18-125 - 127
LOVE-GRUENWALD

18-128
2 mm

18-129
3 mm

18-130
4 mm

18-131
5 mm

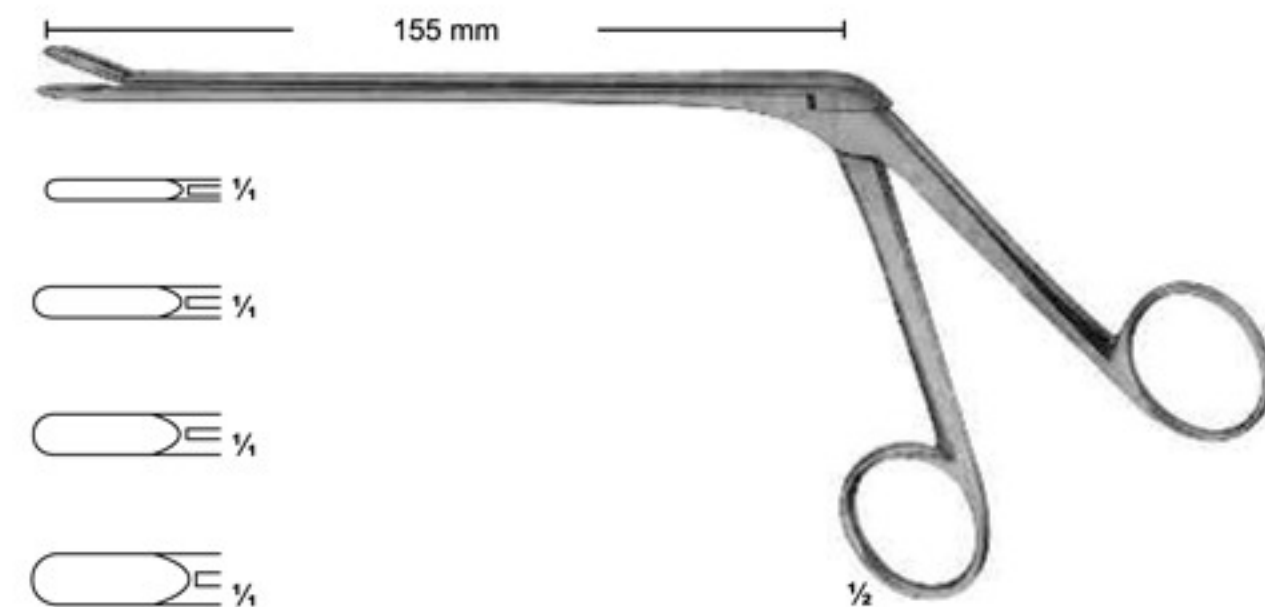

18-128 - 131
CASPAR

18-132
2 mm

18-133
3 mm

18-134
4 mm

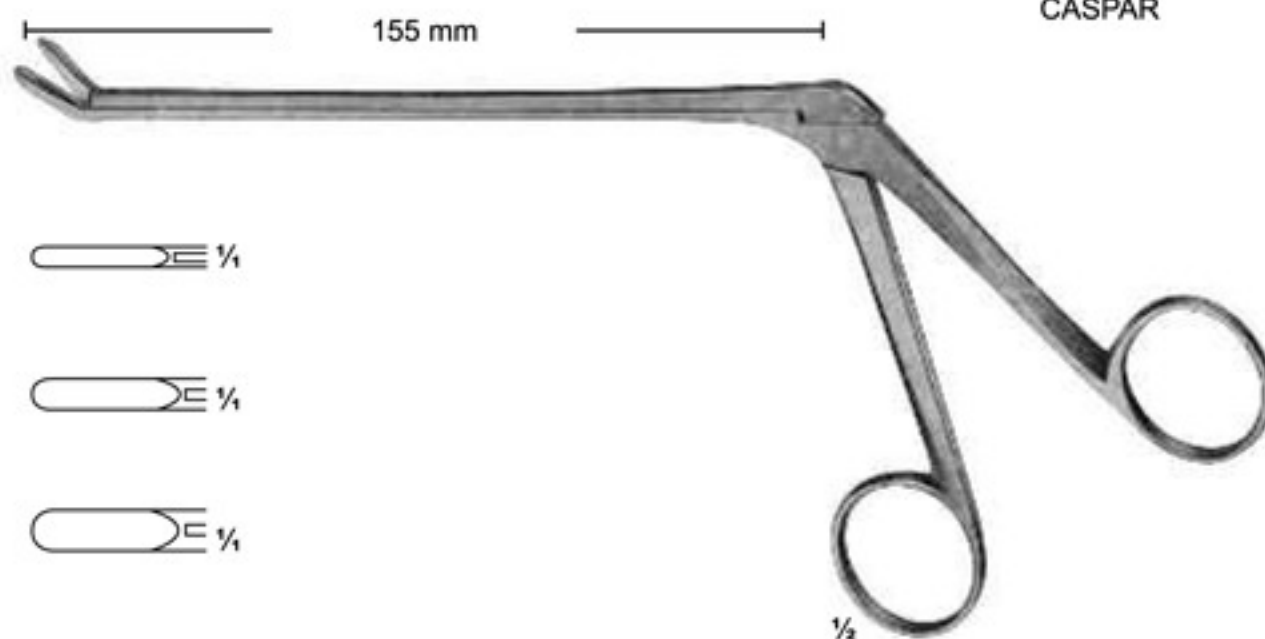

18-132 - 134
CASPAR

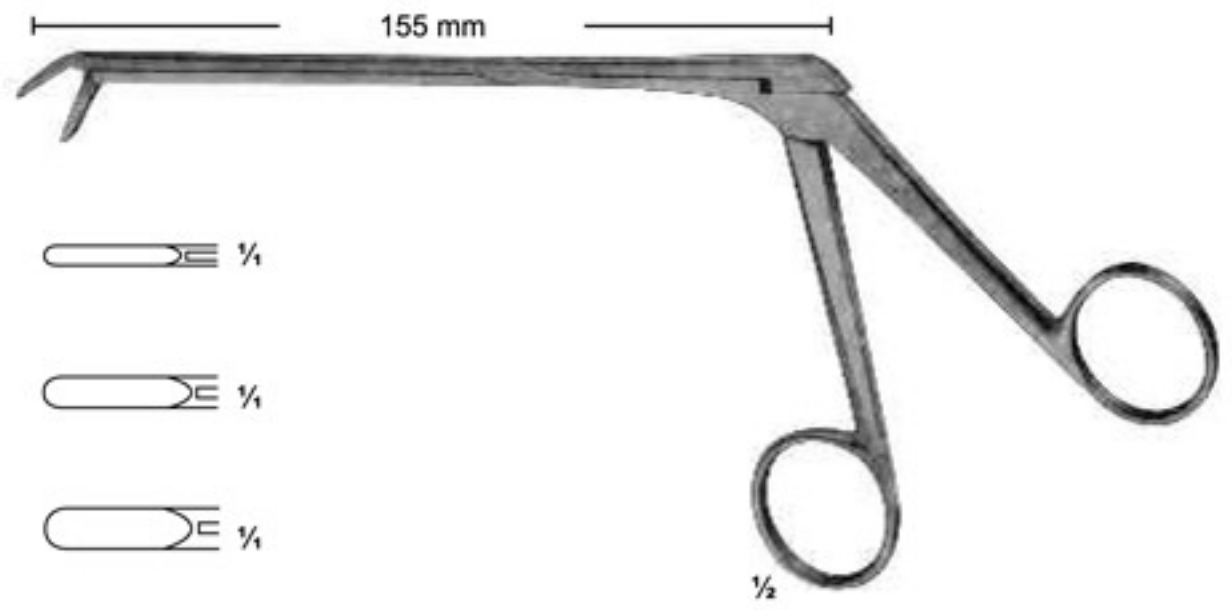

18-135
2 mm



18-136
3 mm



18-137
4 mm



18-135 - 137
CASPAR

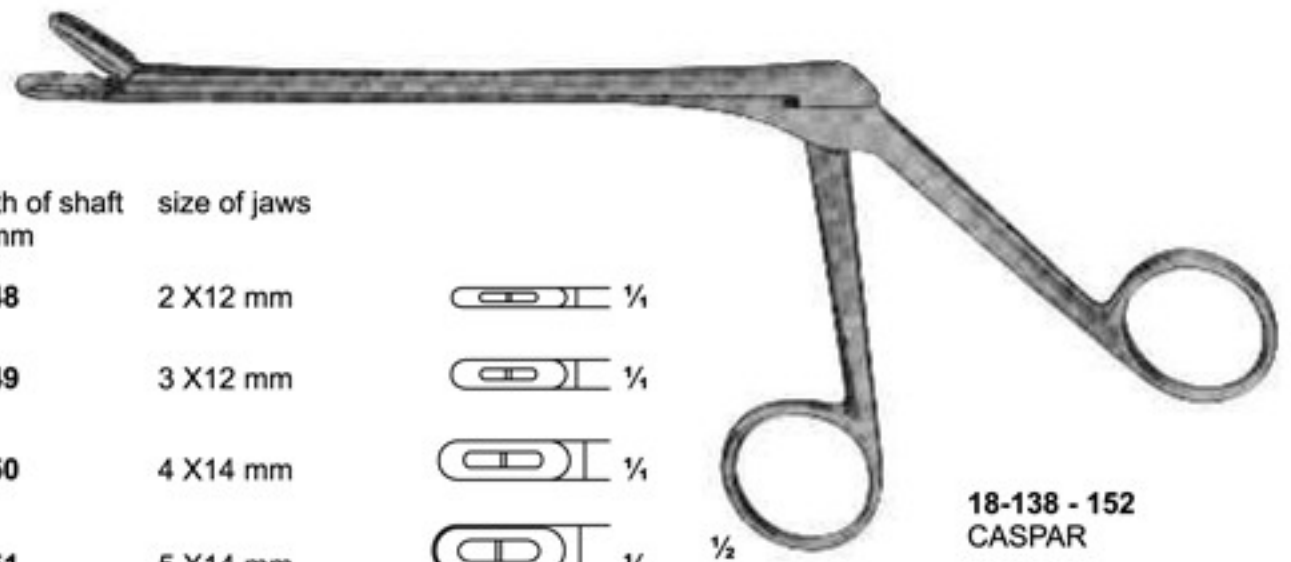

Length of shaft 140 mm	Length of shaft 160 mm	Length of shaft 185 mm	size of jaws
18-138	18-143	18-148	2 X12 mm
18-139	18-144	18-149	3 X12 mm
18-140	18-145	18-150	4 X14 mm
18-141	18-146	18-151	5 X14 mm
18-142	18-147	18-152	6 X16 mm

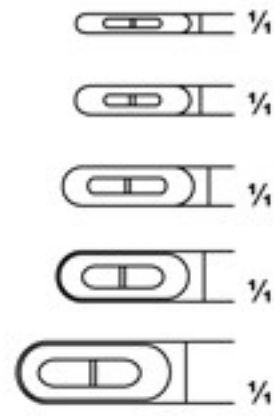

18-138 - 152
CASPAR

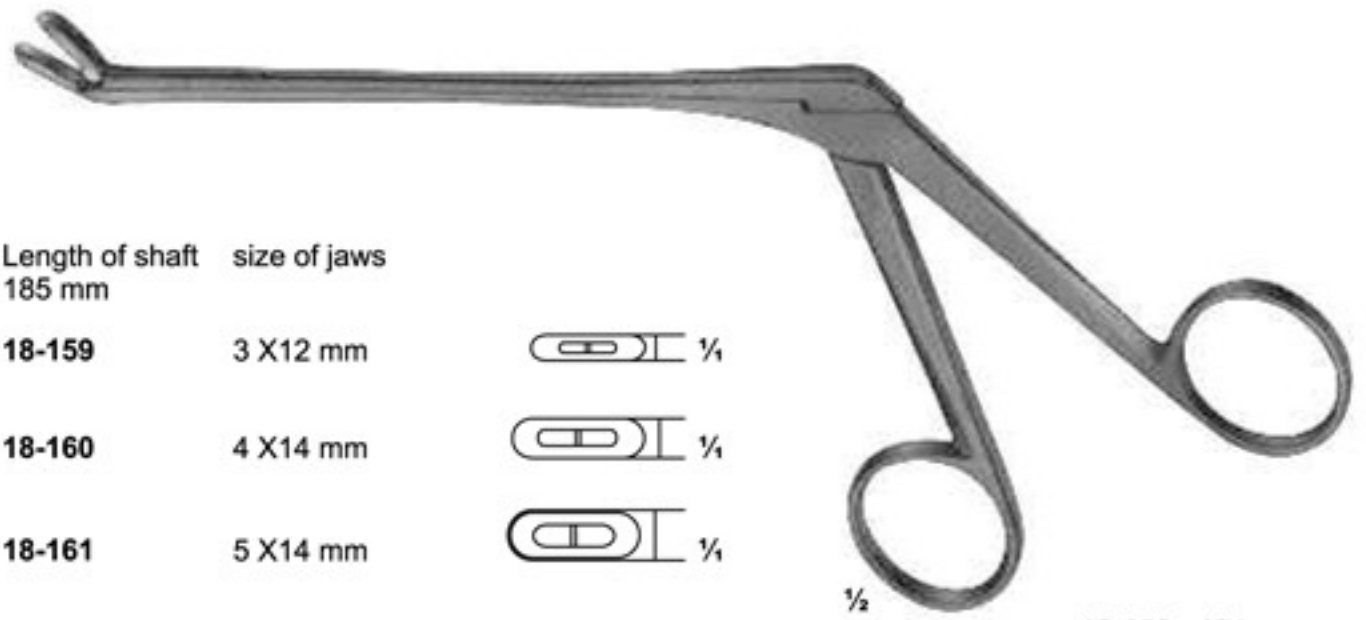

Length of shaft 140 mm	Length of shaft 160 mm	Length of shaft 185 mm	size of jaws
18-153	18-156	18-159	3 X12 mm
18-154	18-157	18-160	4 X14 mm
18-155	18-158	18-161	5 X14 mm

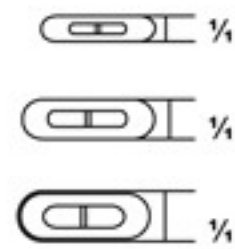

18-153 - 161
CASPAR

Length of shaft 140 mm	Length of shaft 160 mm	Length of shaft 185 mm	size of jaws
18-162	18-164	185-166	3 X 12 mm
18-163	18-165	18-167	4 X 14 mm

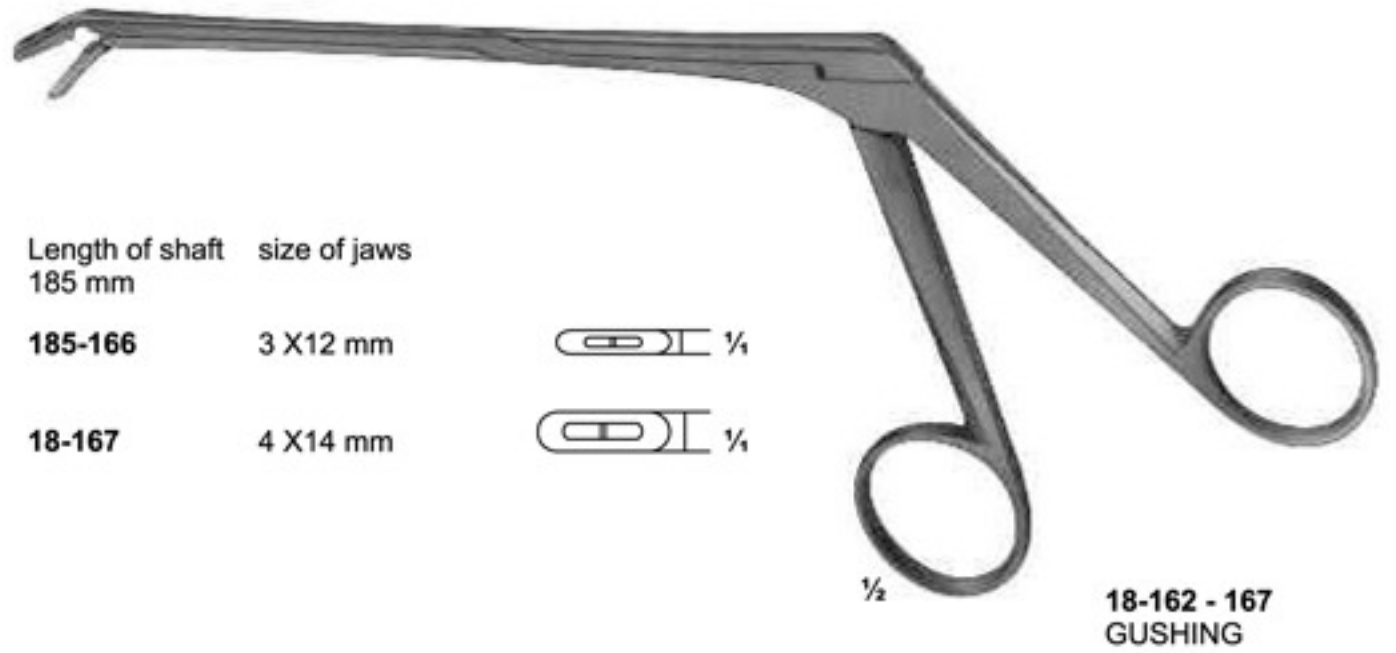
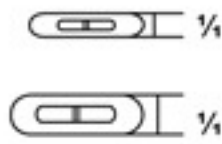

18-168
2 X 10 mm
GUSHING



18-169
3 X 10 mm
LOVE-GRUENWALD

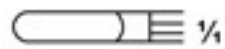

18-170
4 X 10 mm
SPURLING

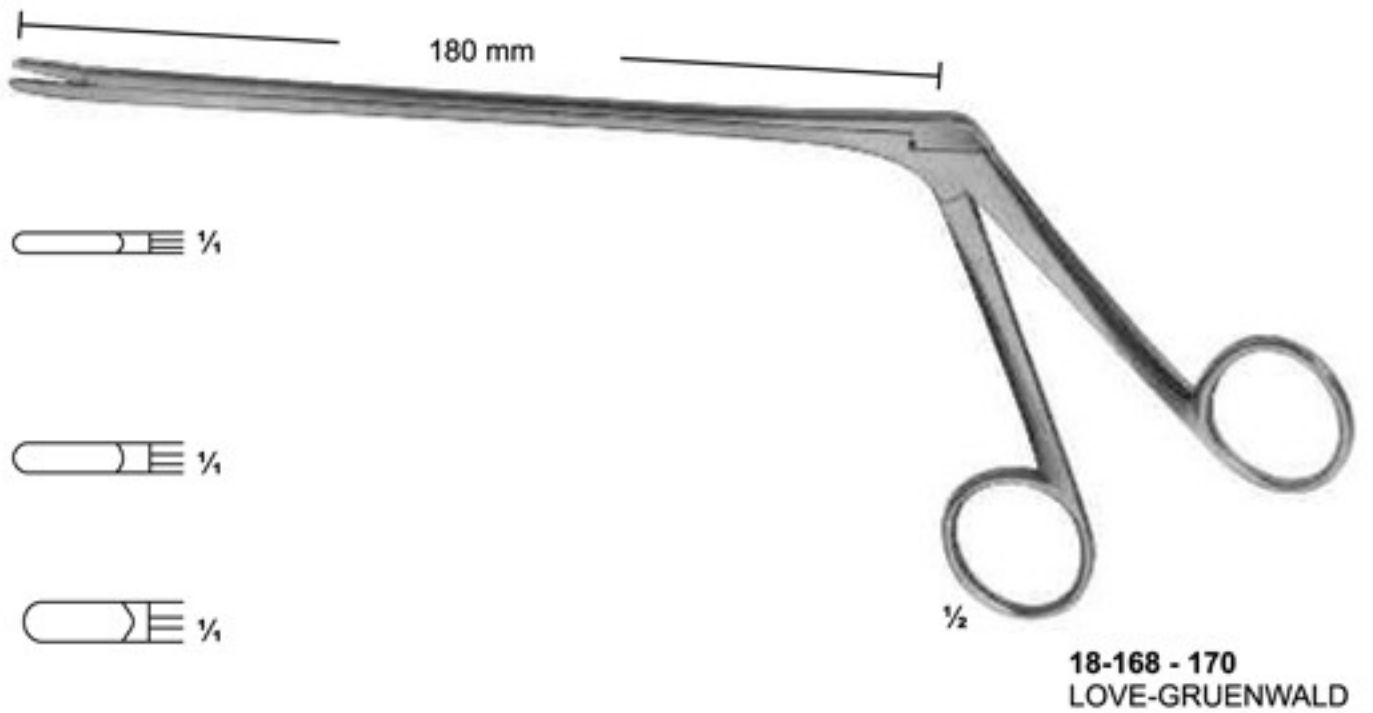
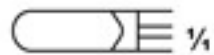

18-171
3 X 10 mm
LOVE-GRUENWALD



18-172
4 X 10 mm
SPURLING

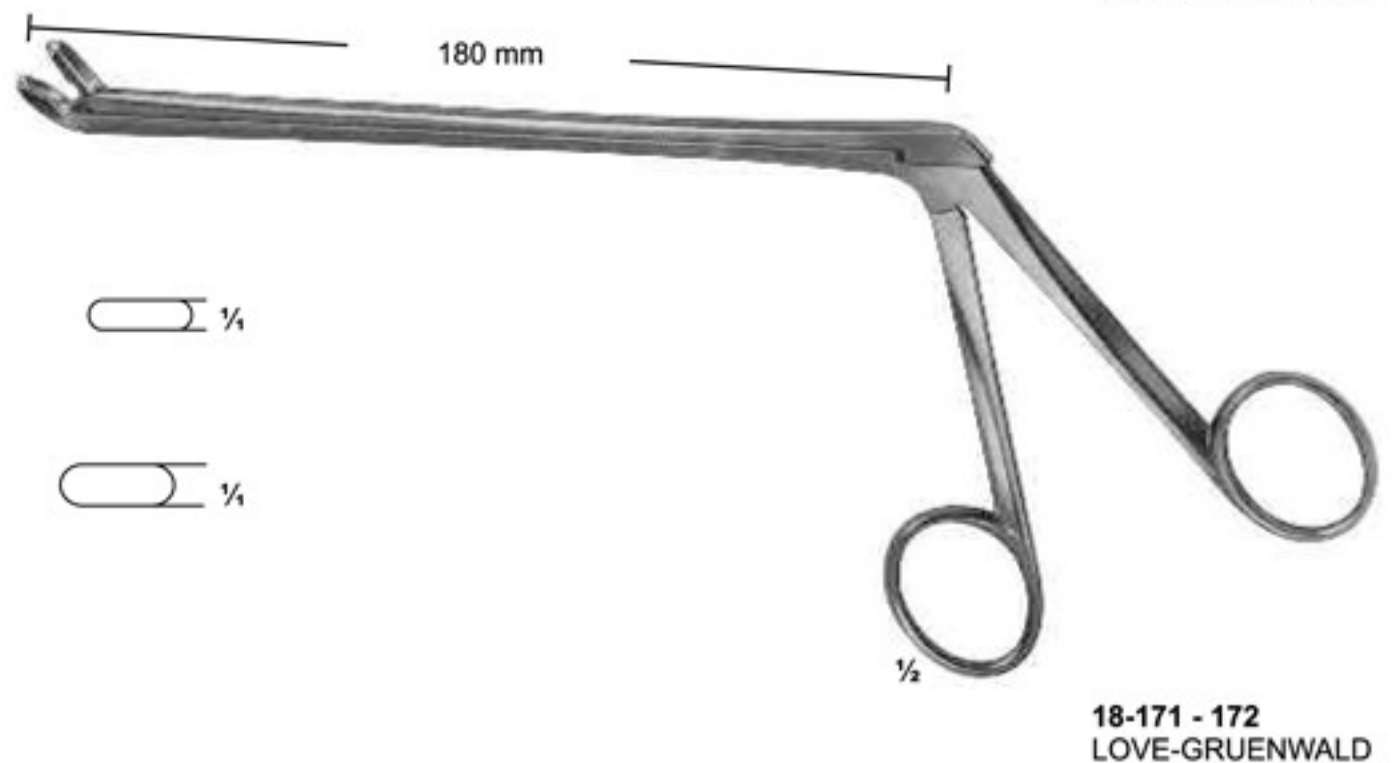

18-173
3 X 10 mm
LOVE-GRUENWALD

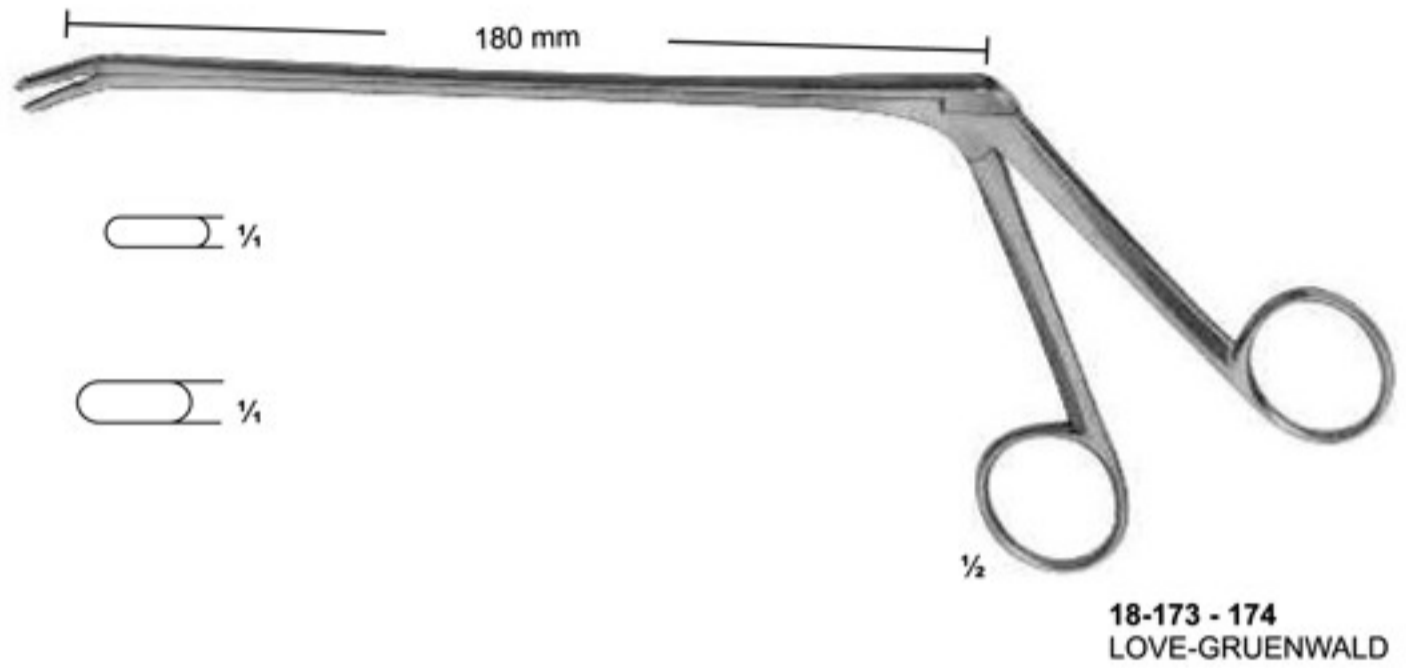

18-174
4 X 10 mm
SPURLING

18-173 - 174
LOVE-GRUENWALD

18-175
7 mm

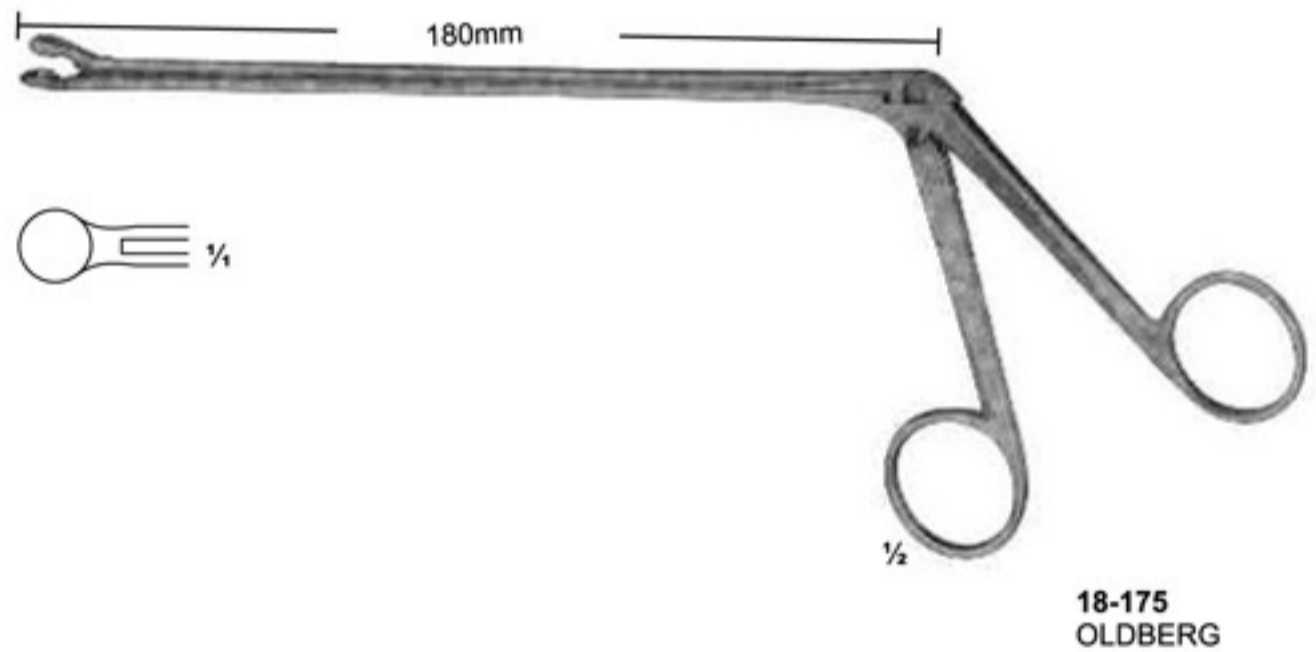

18-175
OLDBERG

18-176
YASARGIL
2,2 mm

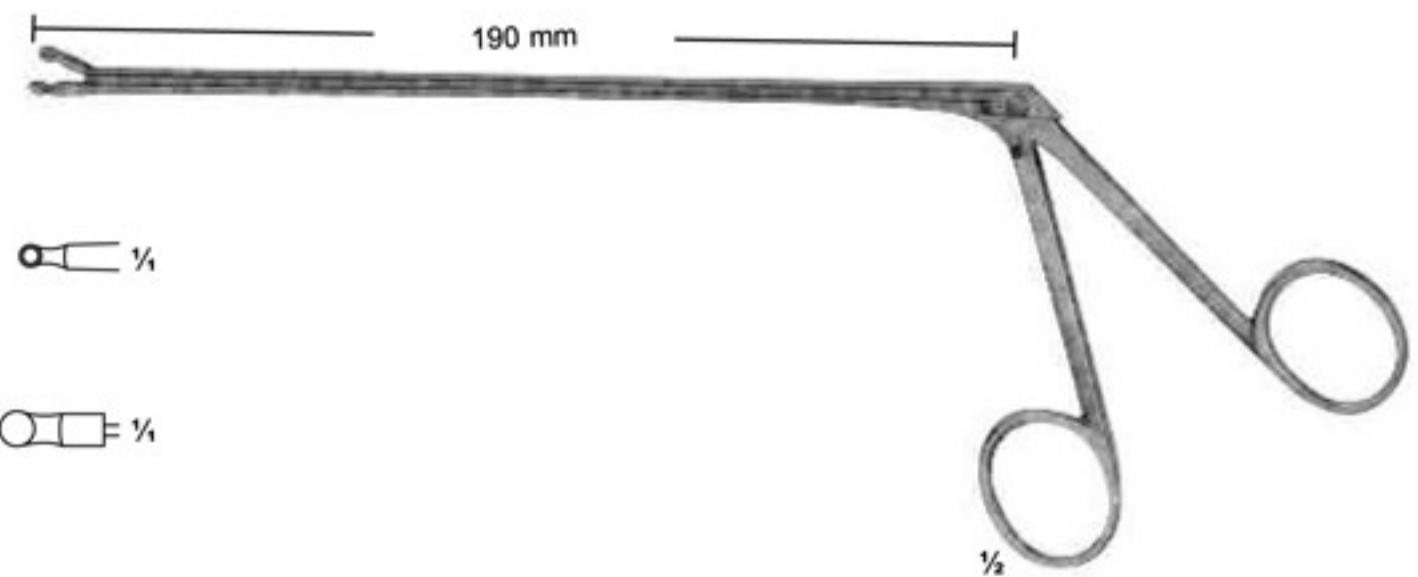

18-177
YASARGIL
3,5 mm

18-176 - 177

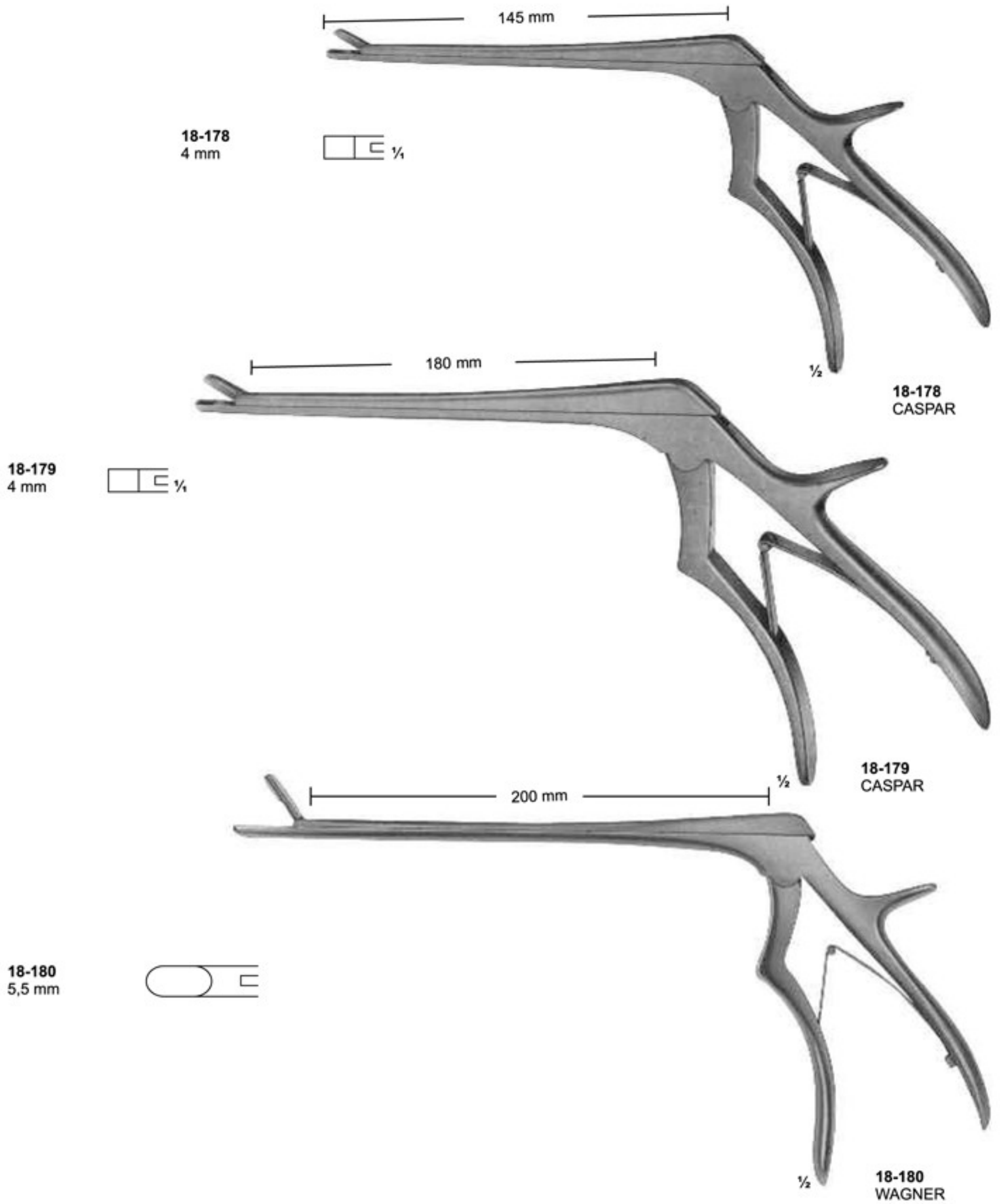



19-101
 Comprimeter. Compression apparatus for producing exsanguination in the extremities. Manometer registers up to 600 mm Hg. Complete, consisting of :
19-101 2 Pump with manometer
19-102 3 Cuff for the leg
19-103 14 Cuff for the upper arm



19-104 3 Cuff for the leg
19-105 4 Cuff for the lower arm
19-106 5 Cuff for children
19-107 14 Cuff for the upper arm

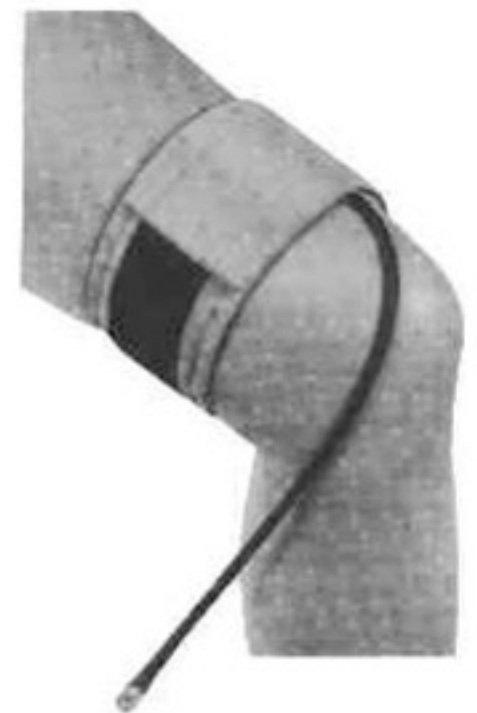

19-108
 ESMARCH
 Staubinde
 Compression bandage
 5 m lang/long
 6 cm breit/wide



19-109
 ESMARCH
 Stauschlauch
 Compression tube
 1 m lang/long



½
19-110
Length of blades
Phalangeal knife
105 mm



½
19-111
Length of blades
Interosseous knife
110 mm



½
19-112
Length of blades
Periosteum knife
with raspator
65 mm



½
19-113 - 114
LANGENBECK
Length of blades
Resection knives
55 mm



19-113



19-114

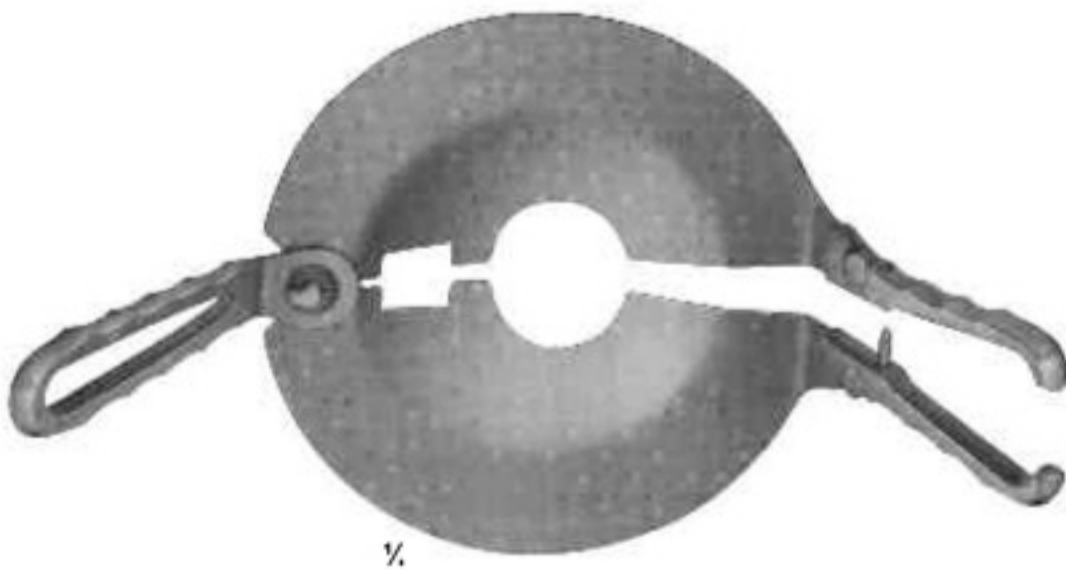

1/2

19-115
PERCY
removeable handles

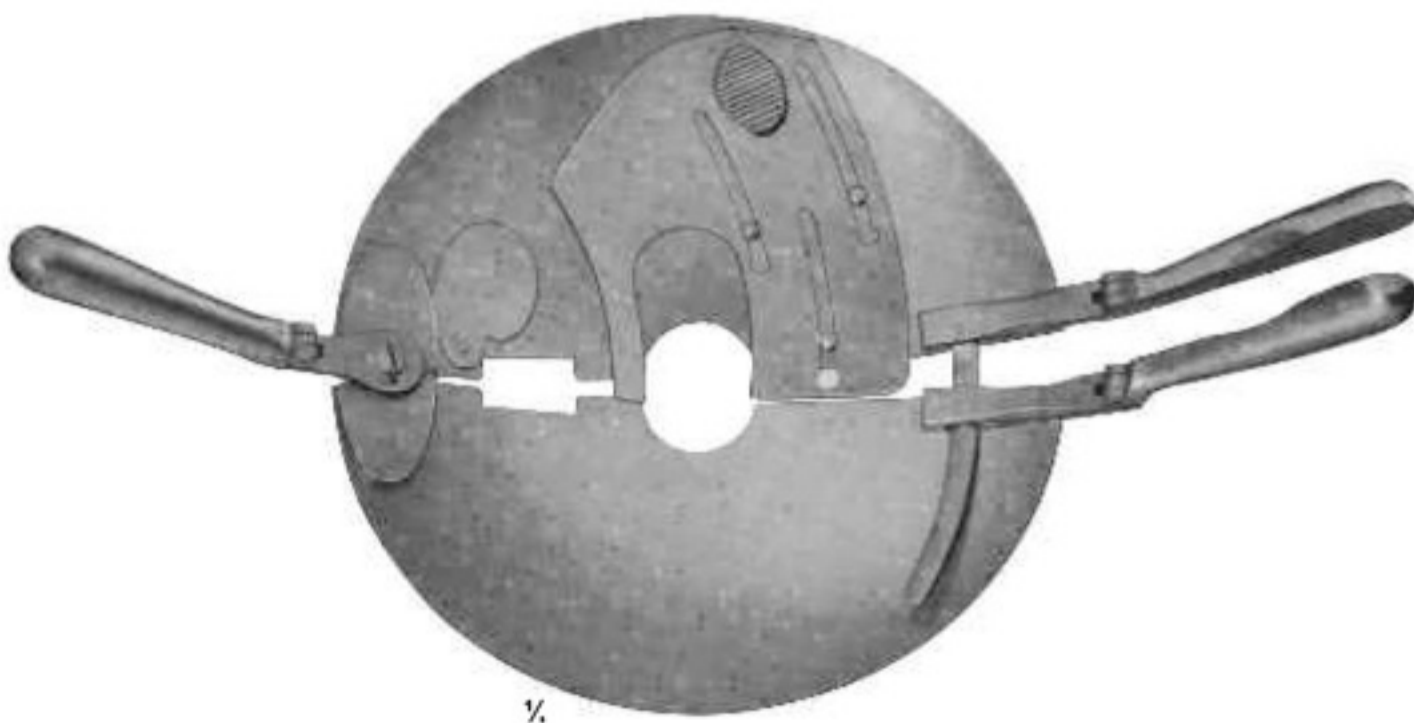

1/2

19-116
PERCY
reversible handles



1/2
19-117
CHARRIÈR
 Length of blade
 215 mm
 complete with one saw
 blade each
 350 mm
 Spare saw blades, carbon steel
19-118 12 mm
19-119 20 mm

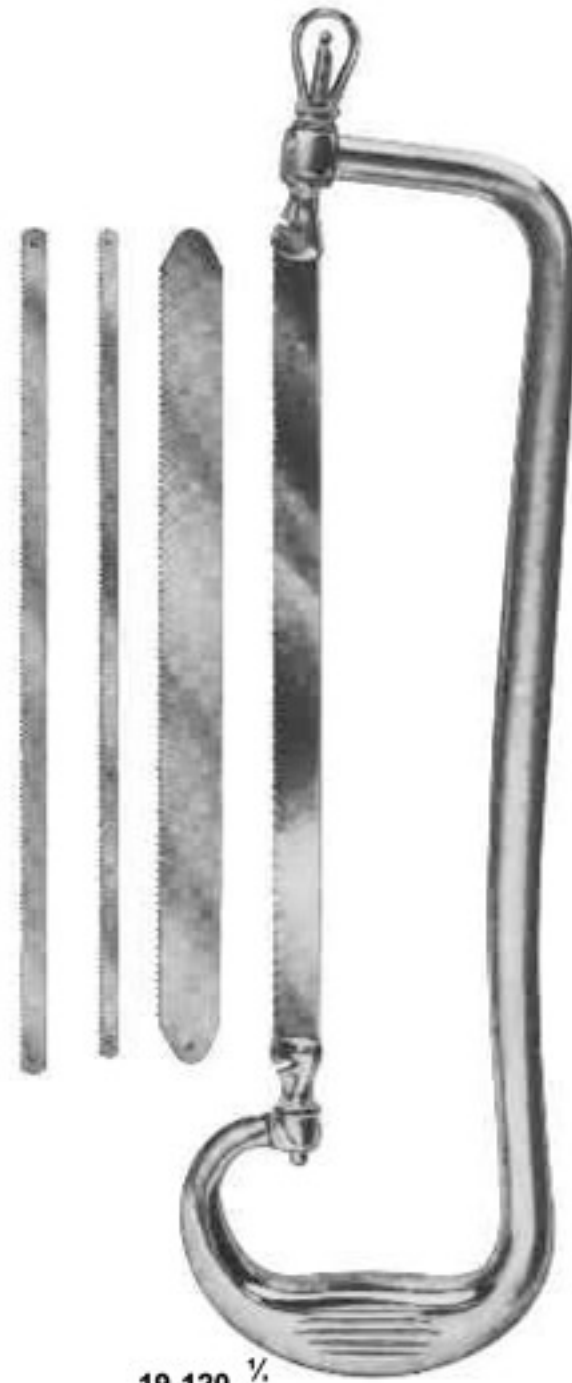

1/2
19-120
RUST
 Length of blade
 235 mm
 complete with one saw
 blade each
 390 mm
19-121 Bow only
 Spare saw blades, carbon steel
19-122 6 mm
19-123 8 mm
19-124 12 mm
19-125 20 mm



1/2

19-126
BIER
Length of blade
270 mm
complete with one saw
blade each
420 mm
Spare saw blades, carbon steel
19-127 4 mm
19-128 6 mm
19-129 8 mm



1/2

19-130
CHARRIERE
Length of blade
180 mm
Spare saw blades,
carbon steel
270 mm

19-131
CHARRIERE
Length of blade
240 mm
Spare saw blades,
carbon steel
340 mm



1/2

19-132
SATTERLEE
Length of blade
200 mm
Spare saw blades,
carbon steel
290 mm



1/2

19-133
LANGENBACK
Length of blade
115 mm
Metacarpal saw
235 mm



OLIVECRONA
19-134 300 mm
19-135 400 mm
19-136 500 mm
19-137 700 mm



GIGLI
19-138 300 mm
19-139 400 mm
19-140 500 mm
 fine, 6 wires twisted
19-141
 coarses, 4 wires twisted



$\frac{1}{4}$
19-142
GIGLI
 Handle



$\frac{1}{2}$
19-143
LEBSCHE
 Conductor for
 wire saws, malleable
 250 mm

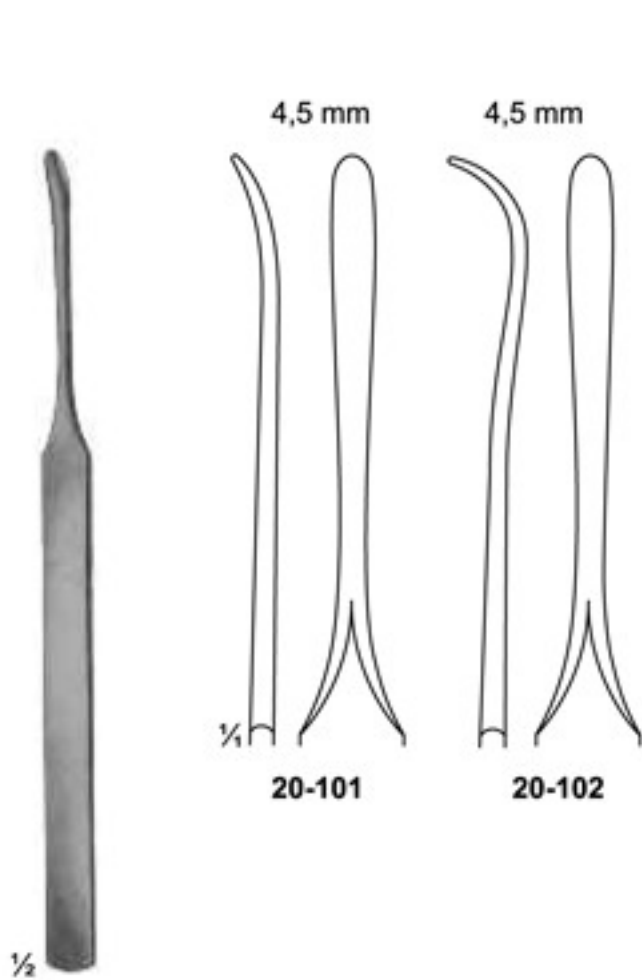

20-101 - 102
KONIG
155 mm



20-103
WILLIGER
165 mm

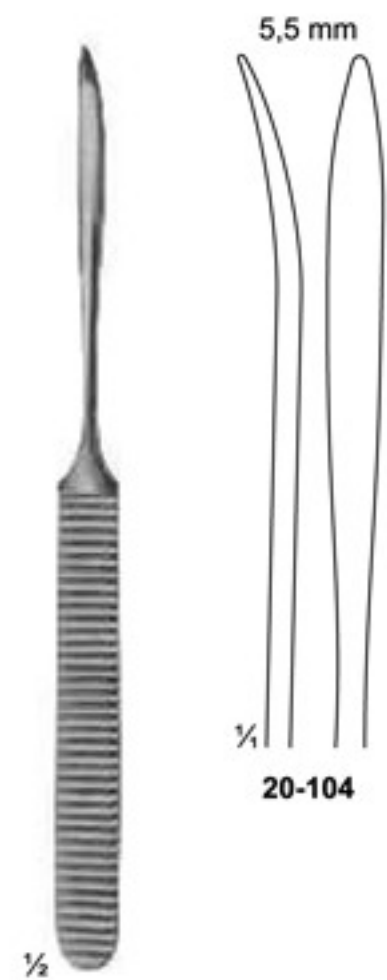

20-104
WILLIGER
170 mm

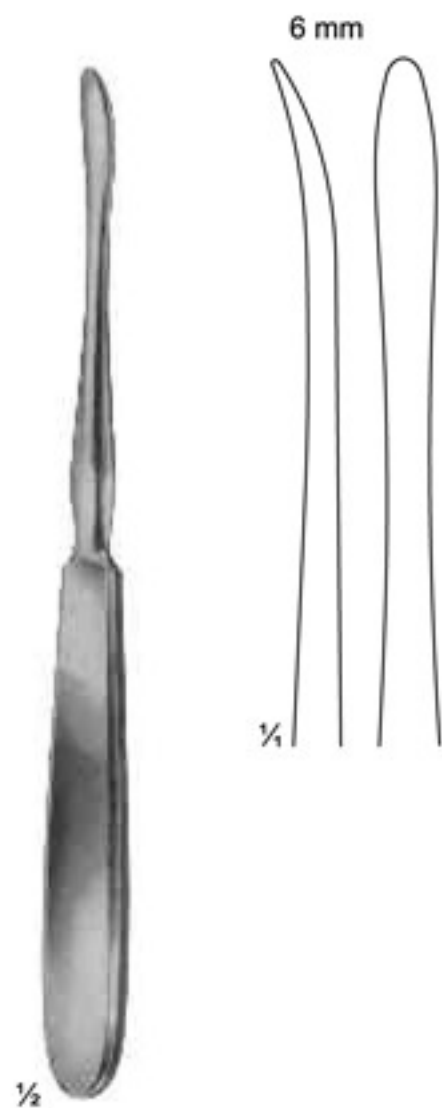

20-105
QUERVAIN
195 mm

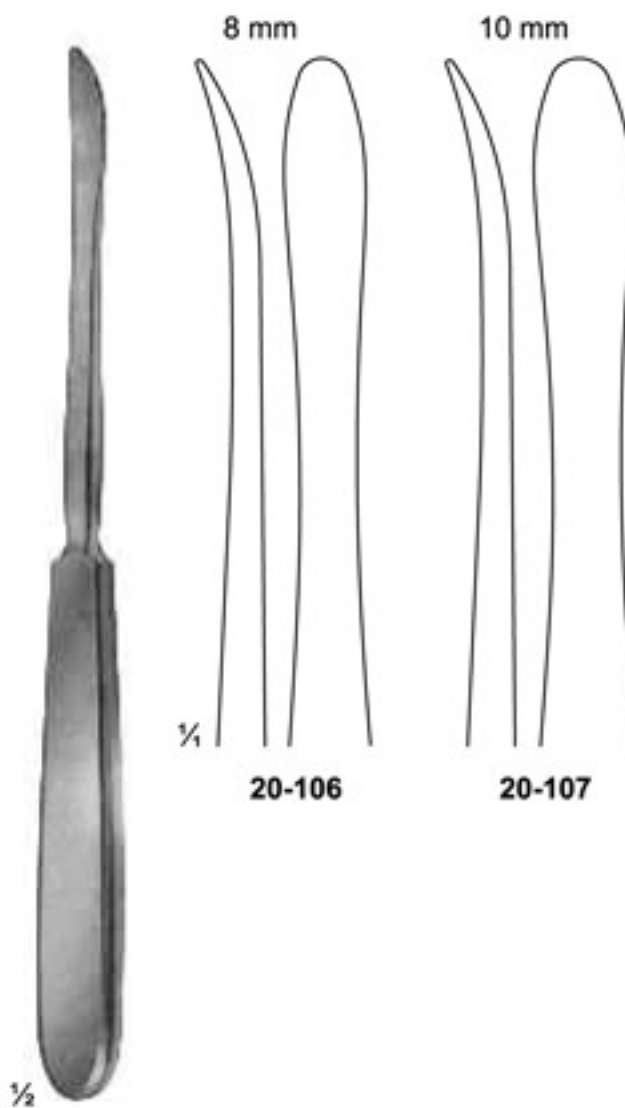

120-106 - 107
LANGENBACK
195 mm

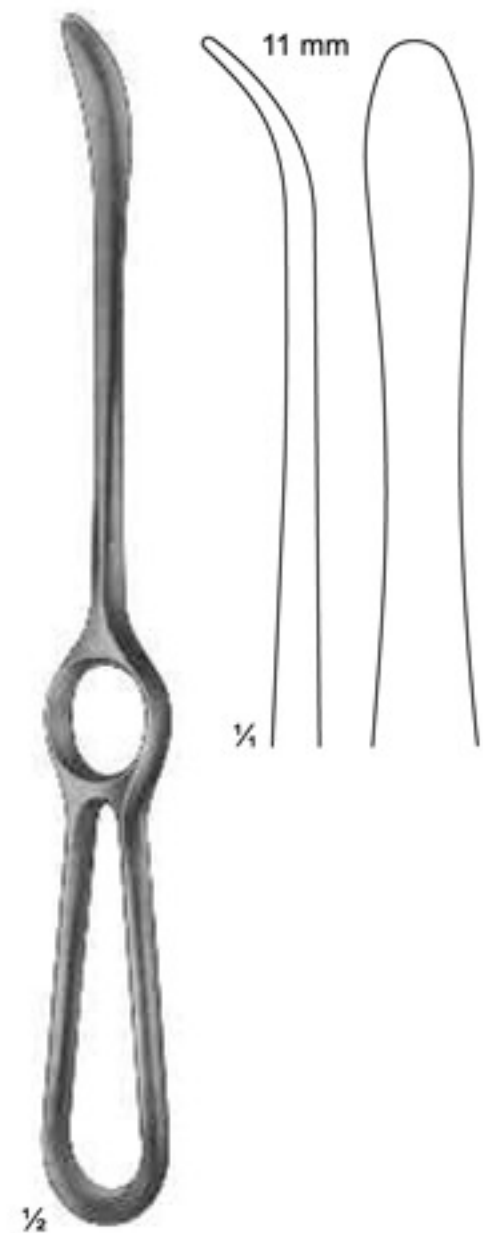

20-108
LANGENBACK
230mm

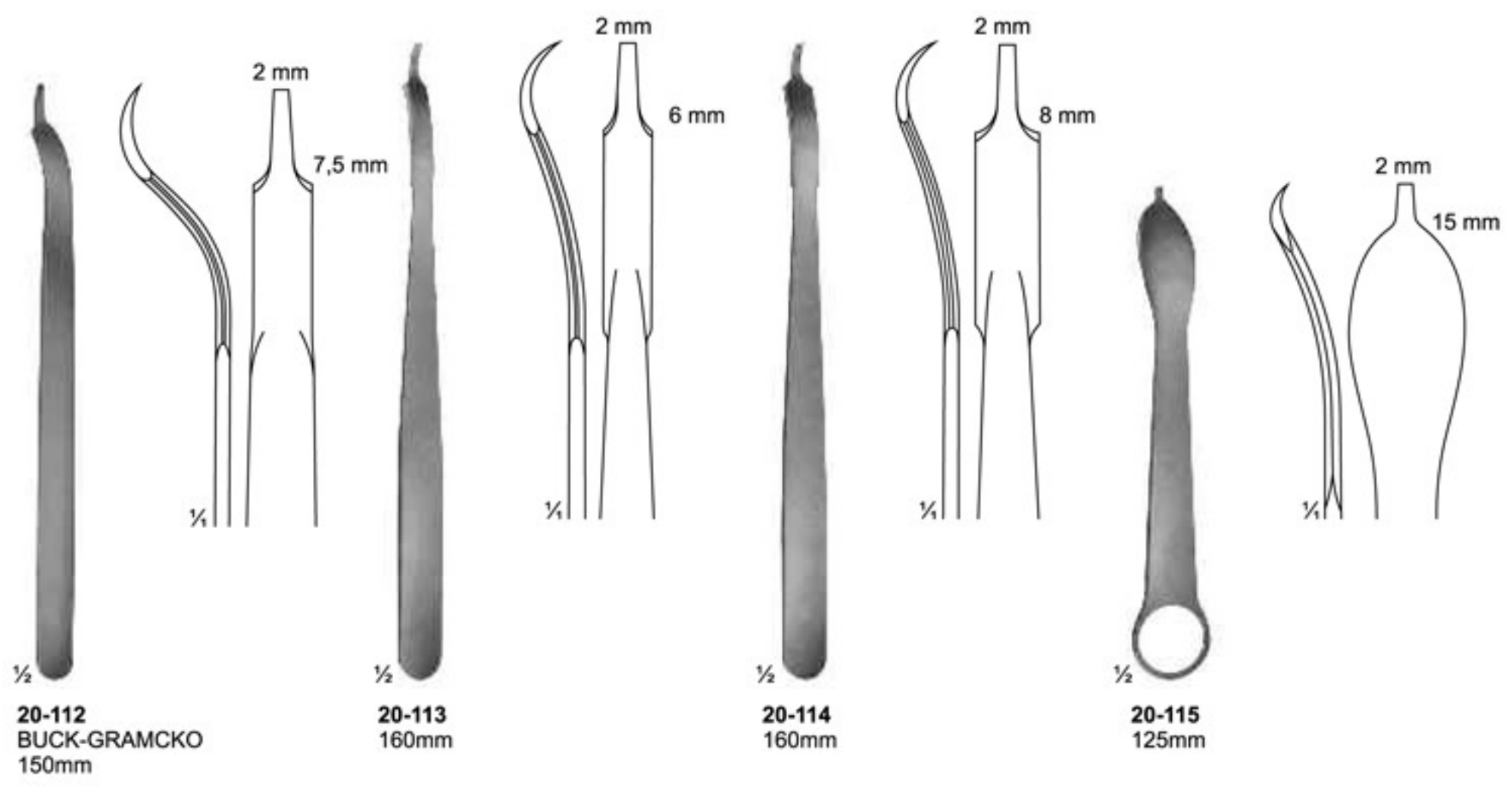
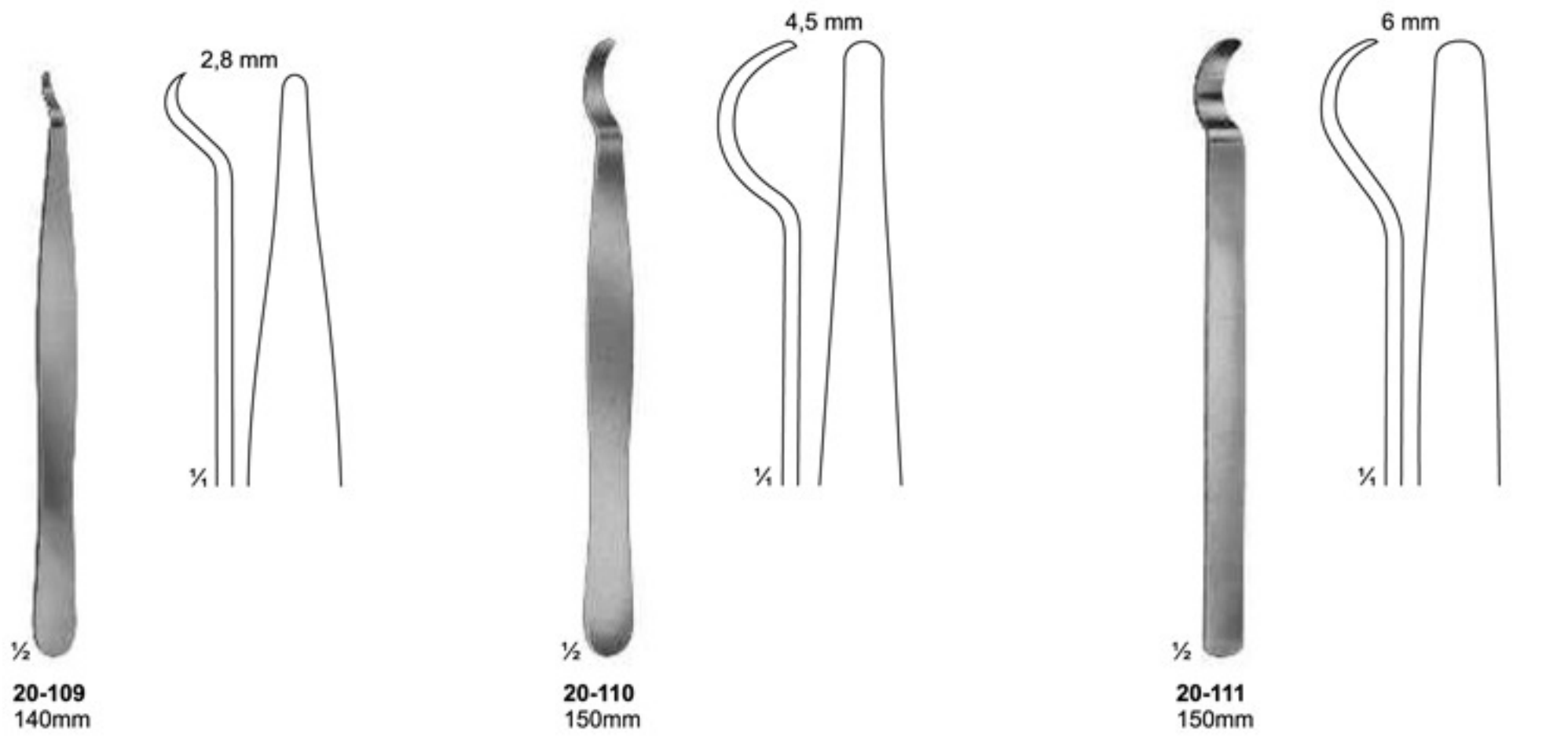



20-116
LANE TRETOWAN
215mm

20-117
LANE
255mm

20-118
LANGE-HOHMANN
250mm

20-119 - 120
LANGE-HOHMANN
20-119 265mm
20-120 280mm

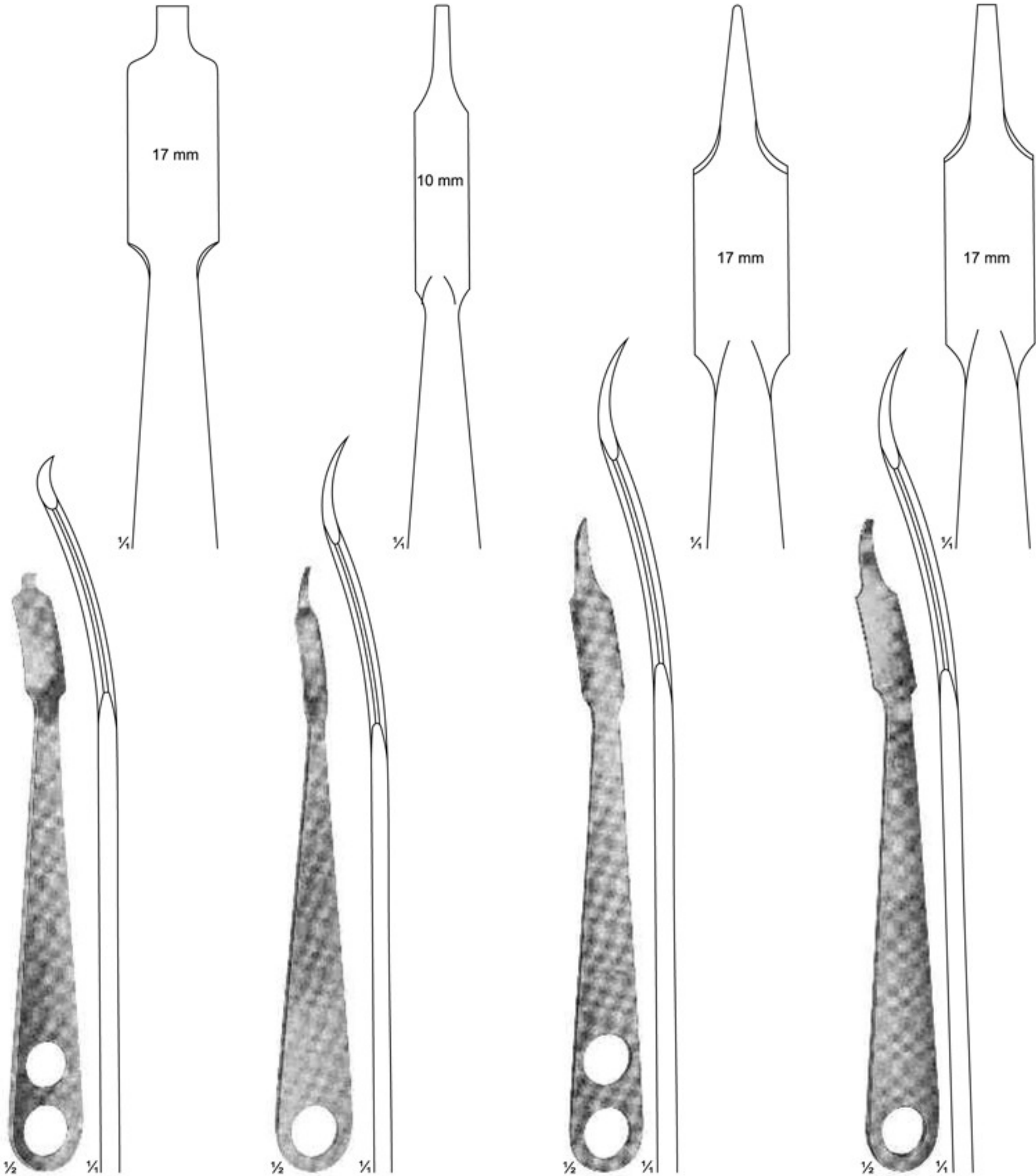

20-121
WAGNER
220 mm

20-122
220 mm

20-123
240 mm

20-124
240 mm

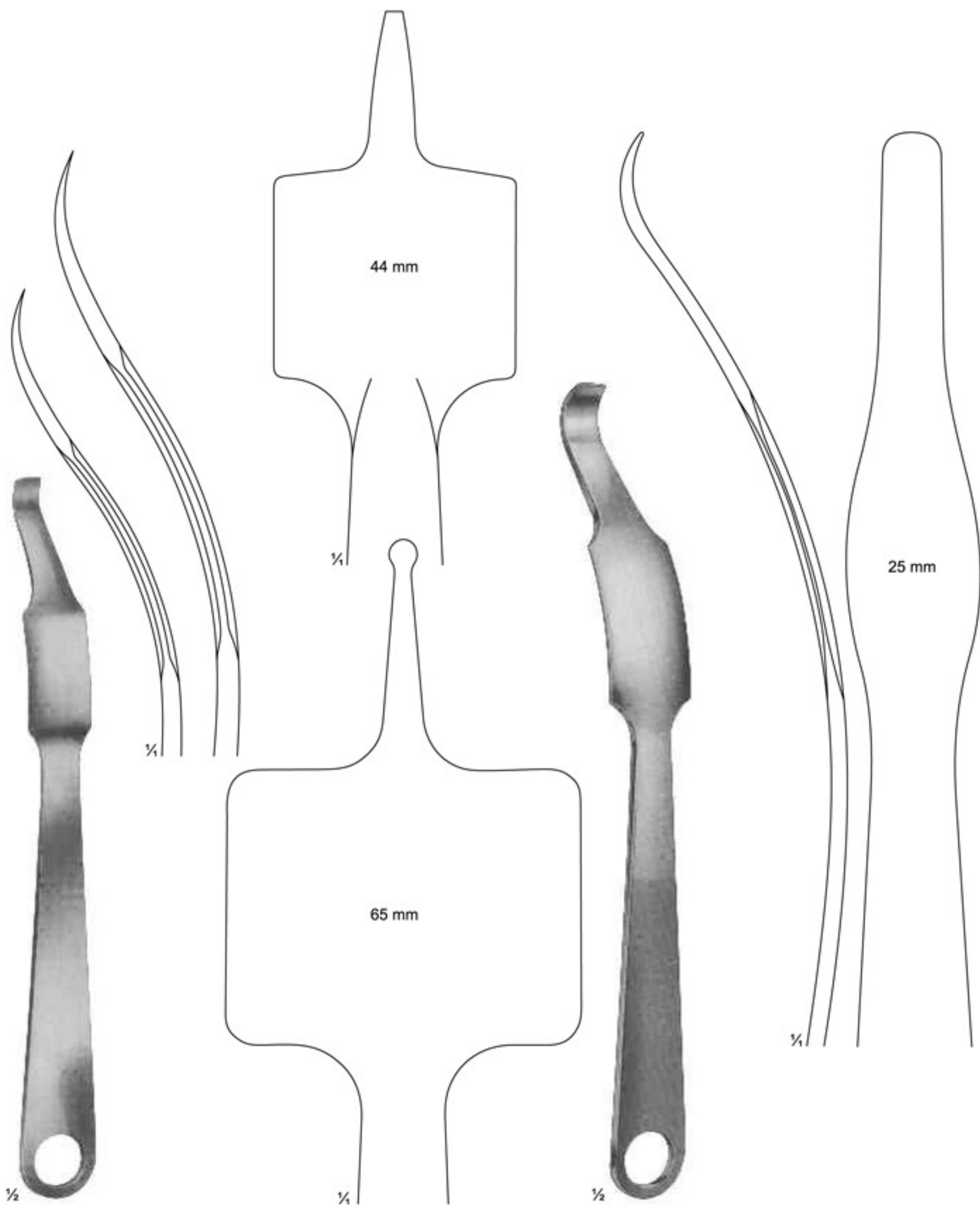

20-125 - 126
VERBRUGGE-MULLER
20-125 240 mm
20-126 255 mm

20-127
260 mm

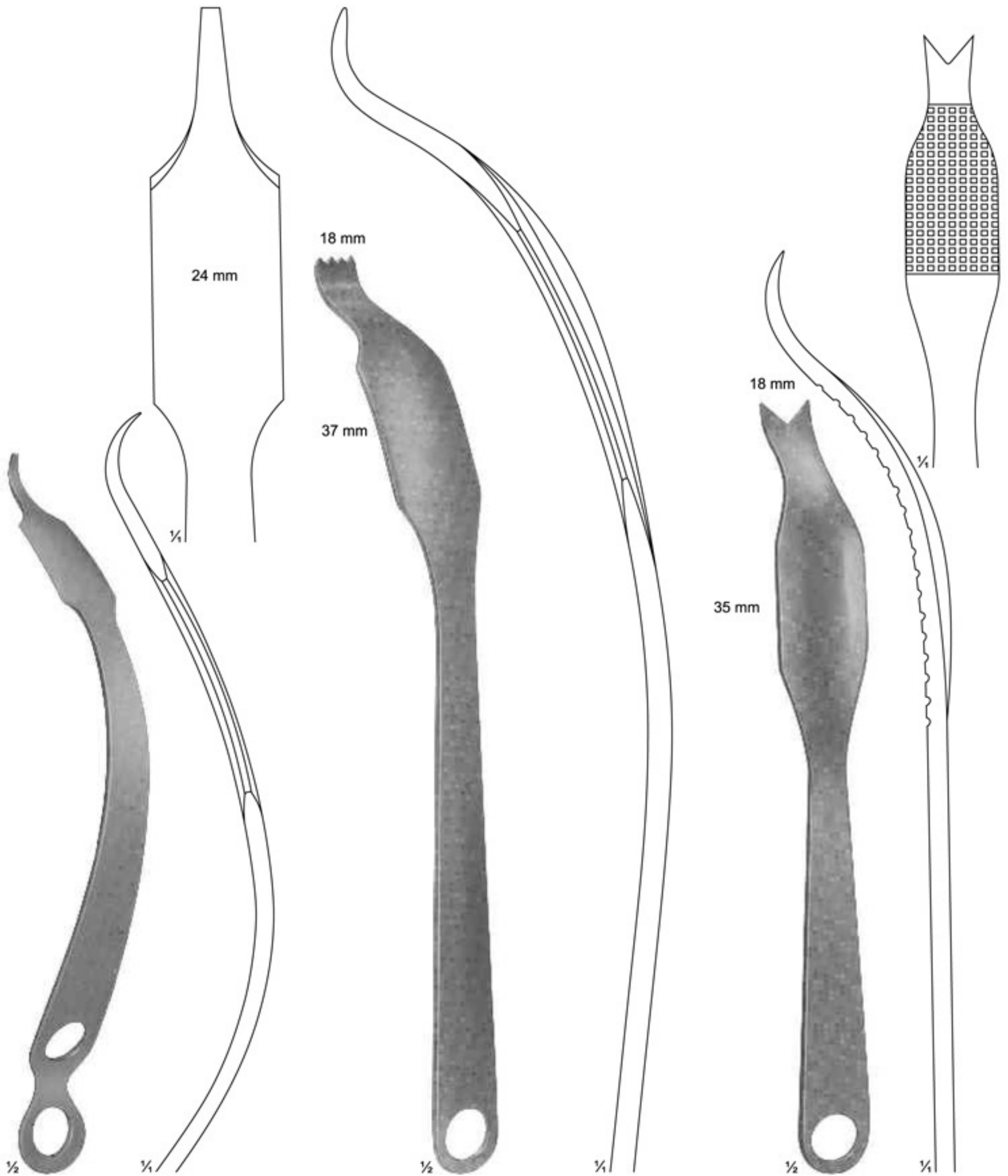

20-128
HOHMANN-ALDINGER
270 mm

20-129
SCHUMACHER mod. WAGNER
345 mm

20-130
SCHUMACHER
290 mm

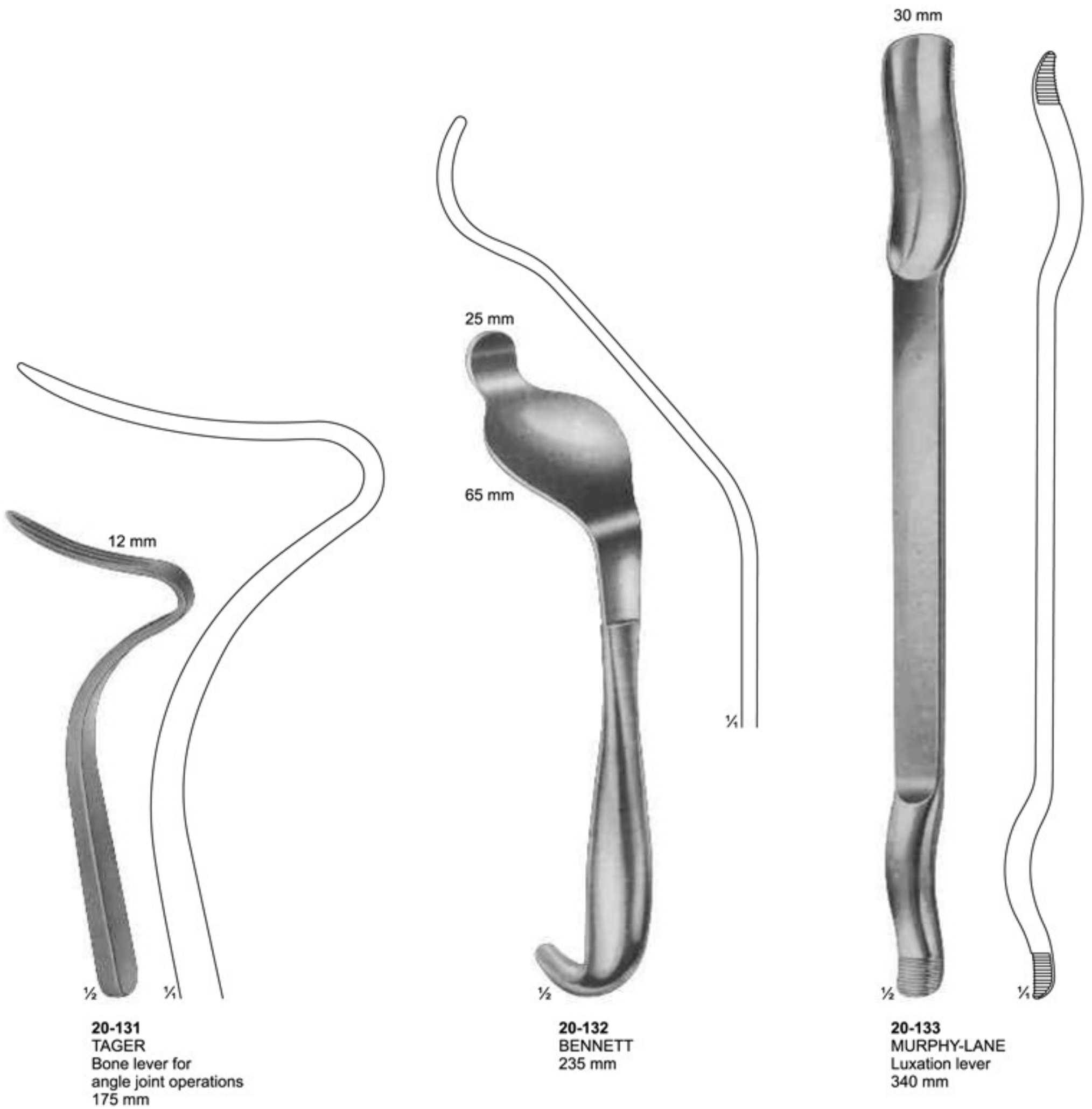



20-134 - 135
PARTSCH
150 mm



20-136
PARTSCH mod. LANGE
145 mm



20-137
MC KENTY
155 mm

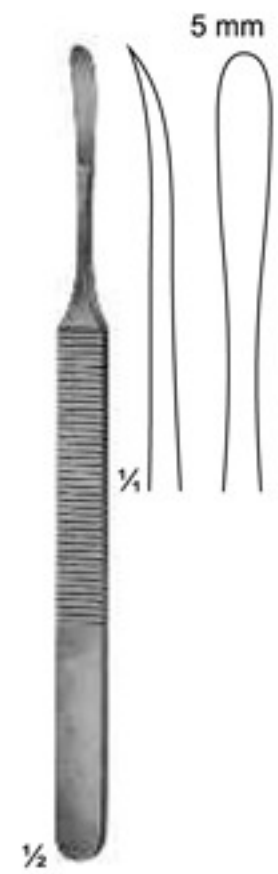

20-138
KONIG
155 mm

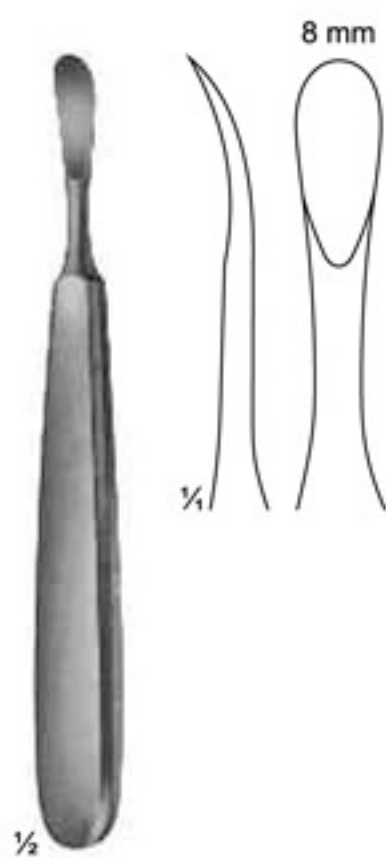

20-139
TRELAT
150 mm

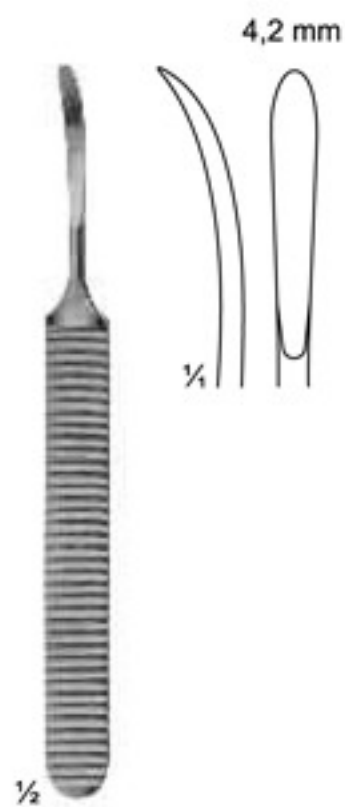

20-140
WILLIGER
140 mm

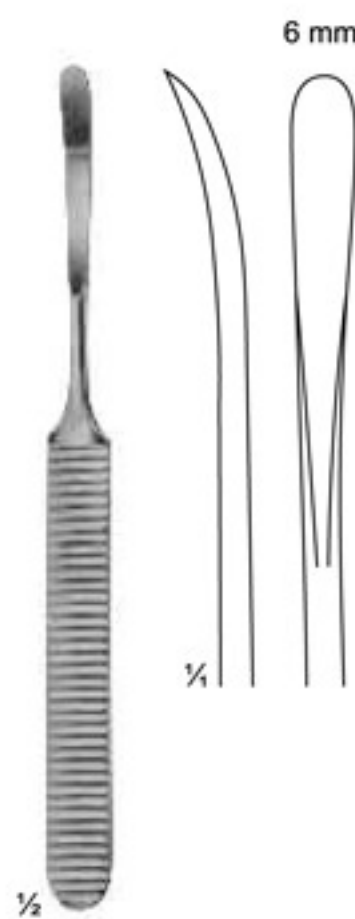

20-141
WILLIGER
160 mm

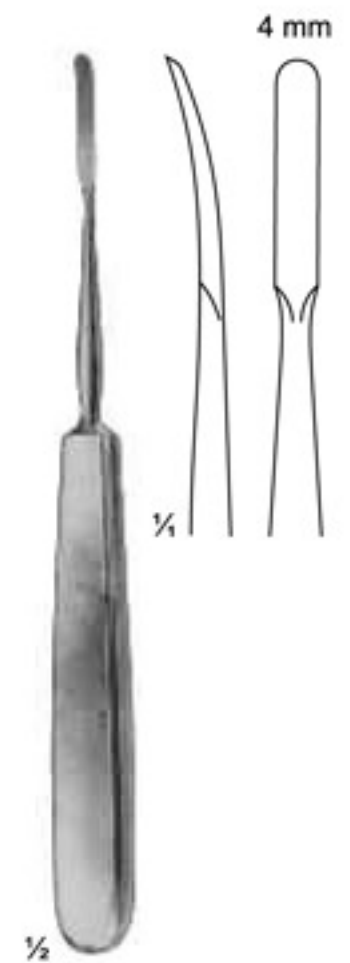

20-142
JOSEPH
170 mm

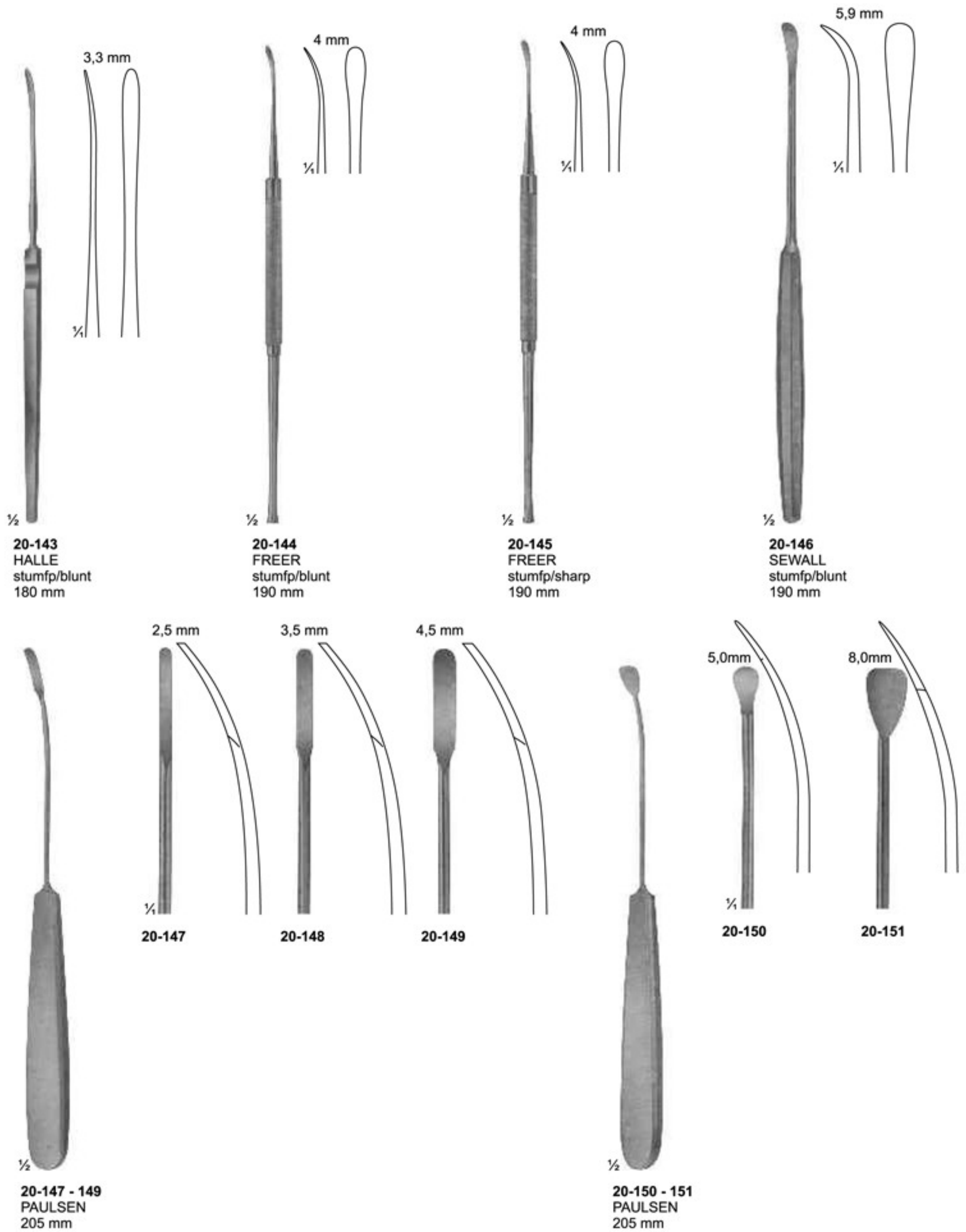

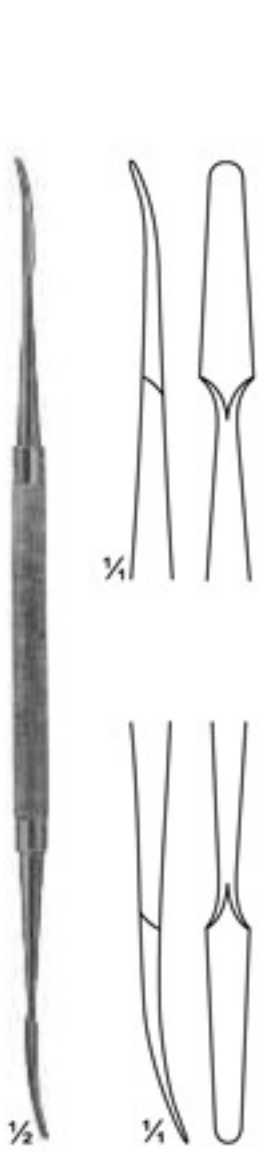

20-152
KILLIAN
sharp/blunt
185 mm

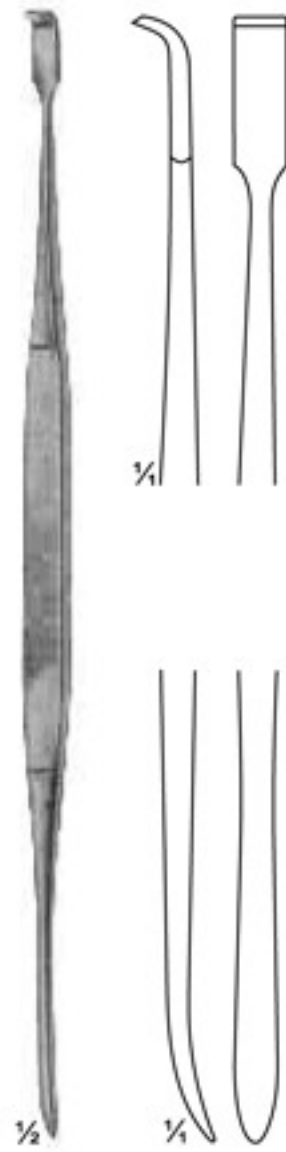

20-153
HOWARTH
sharp/blunt
215 mm

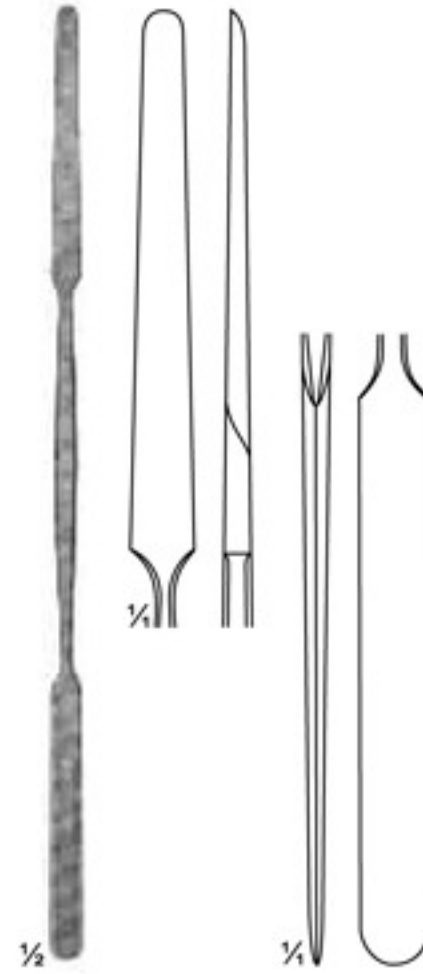

20-154
KILLIAN
sharp/blunt
185 mm

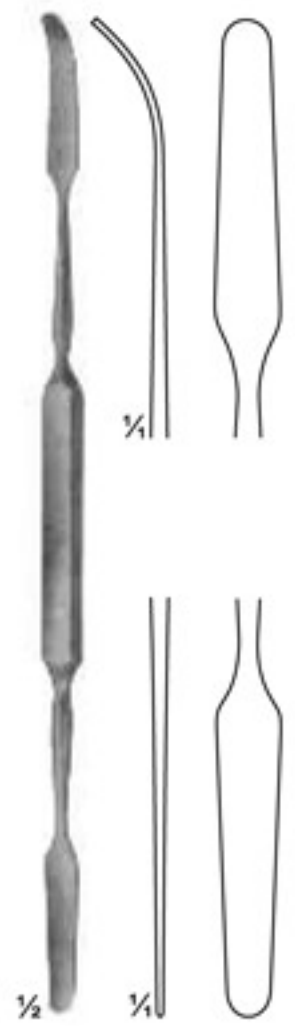

20-155
MAC DONALD
blunt/blunt
185 mm

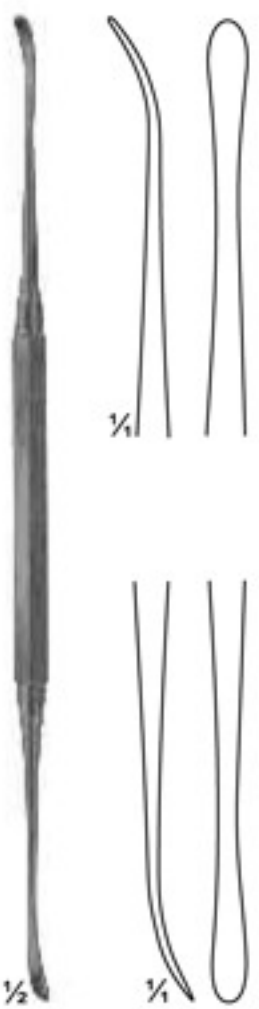

20-156
FREER
sharp/blunt
185 mm

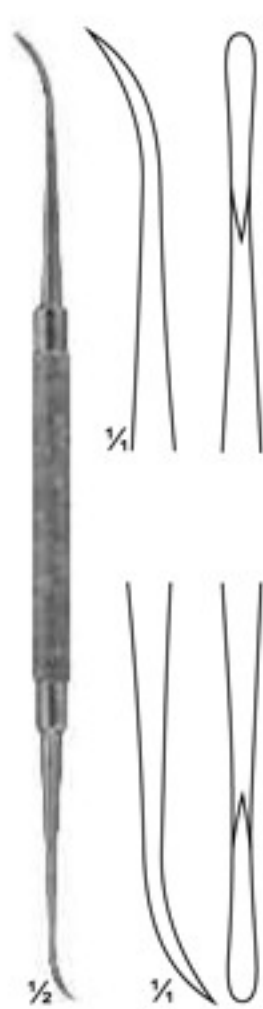

20-157
FREER-YASARGIL
sharp/sharp
185 mm

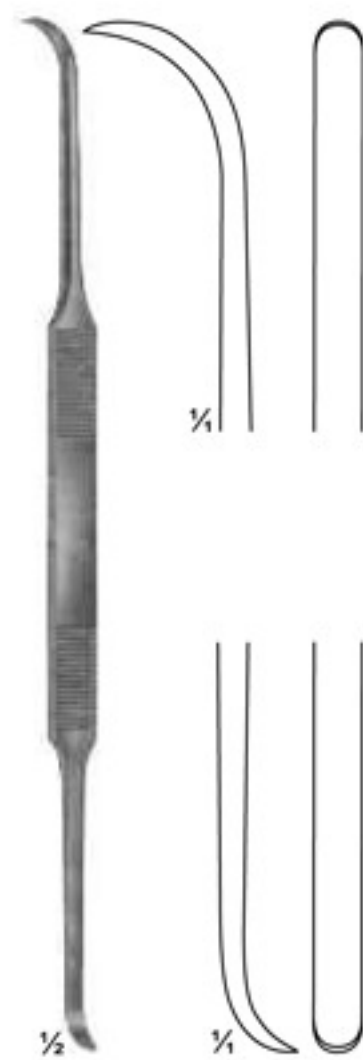

20-158
COTTLE
sharp/sharp
200 mm

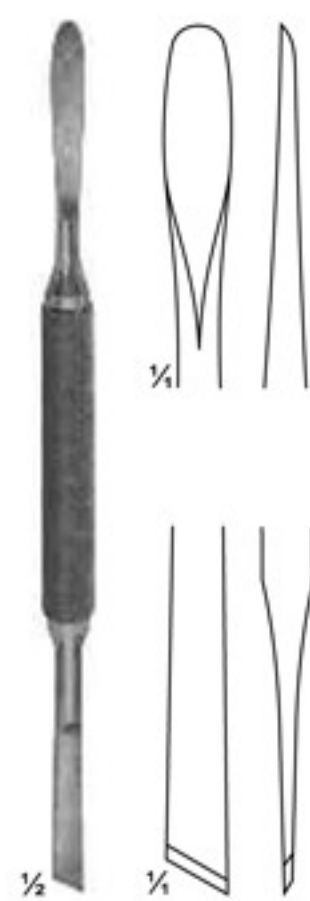

20-159
MEAD
sharp/sharp
165 mm

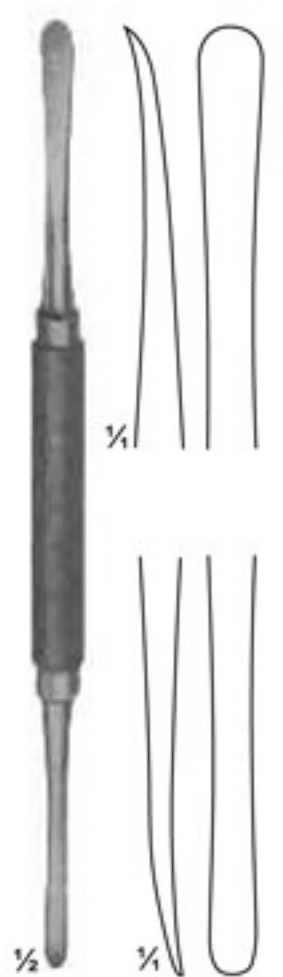

20-160
MOLT
sharp/sharp
180 mm

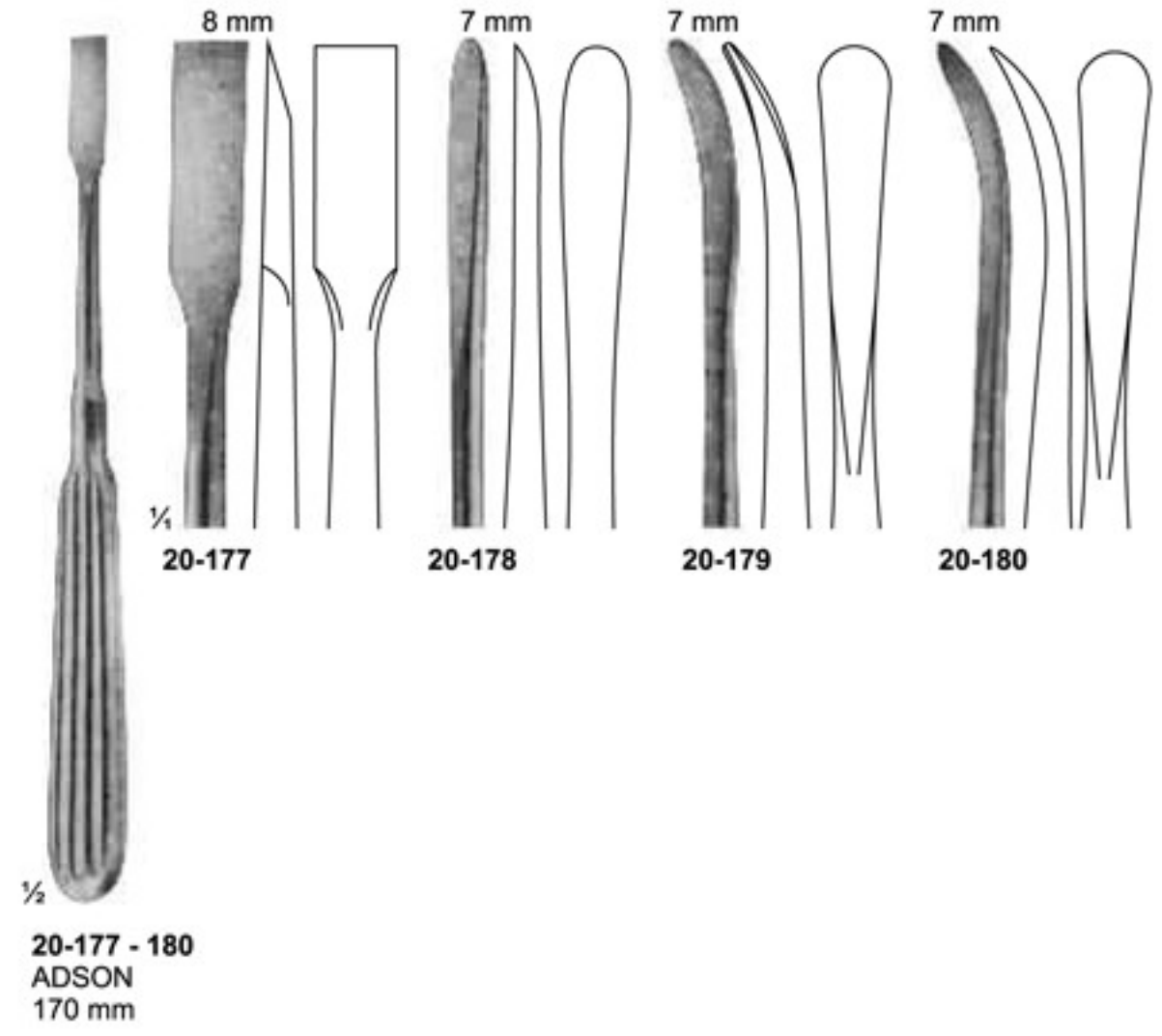
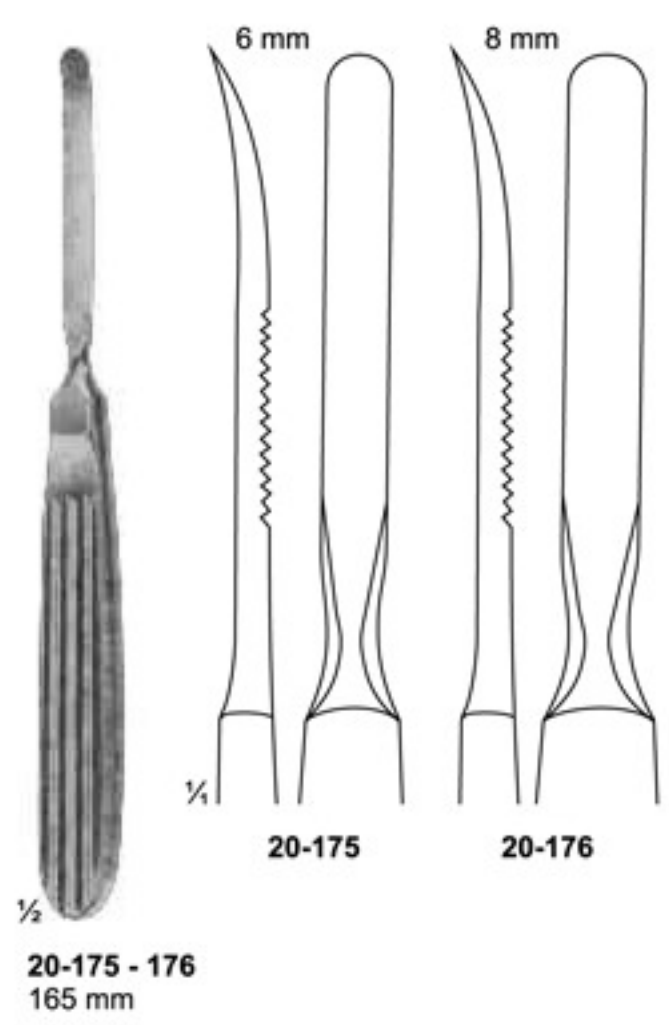
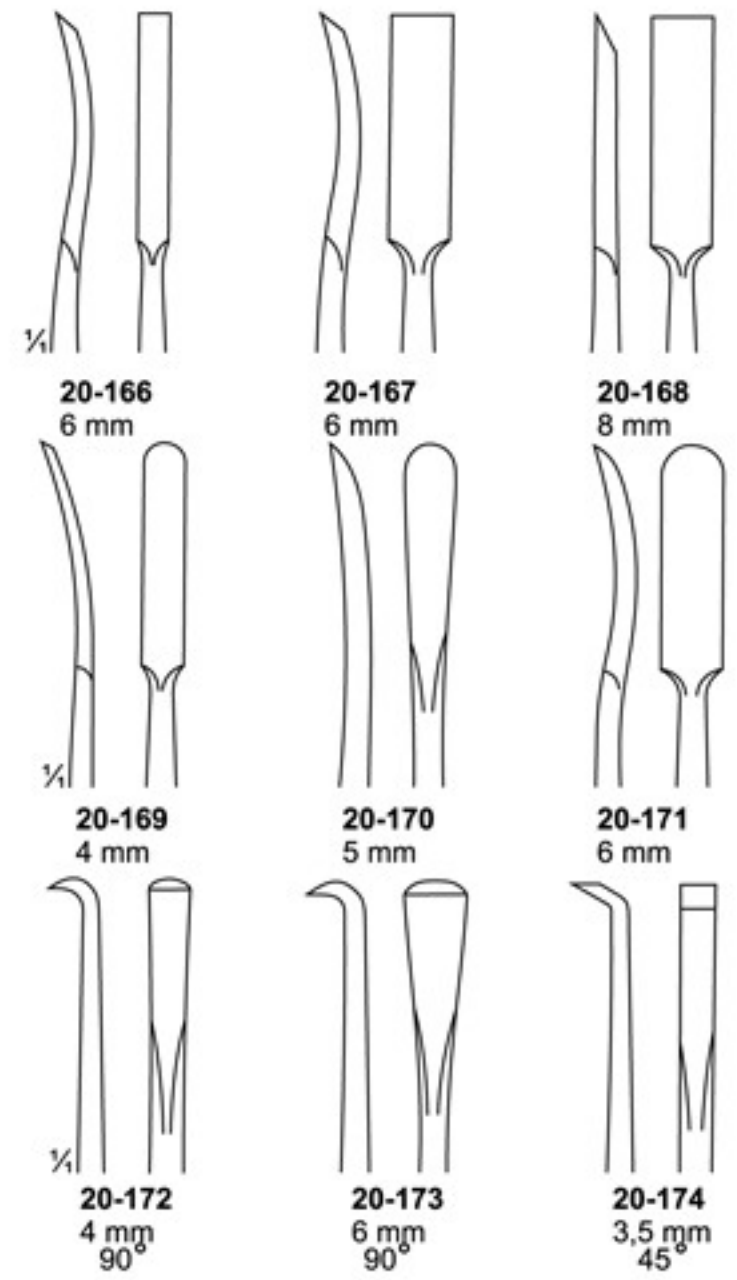
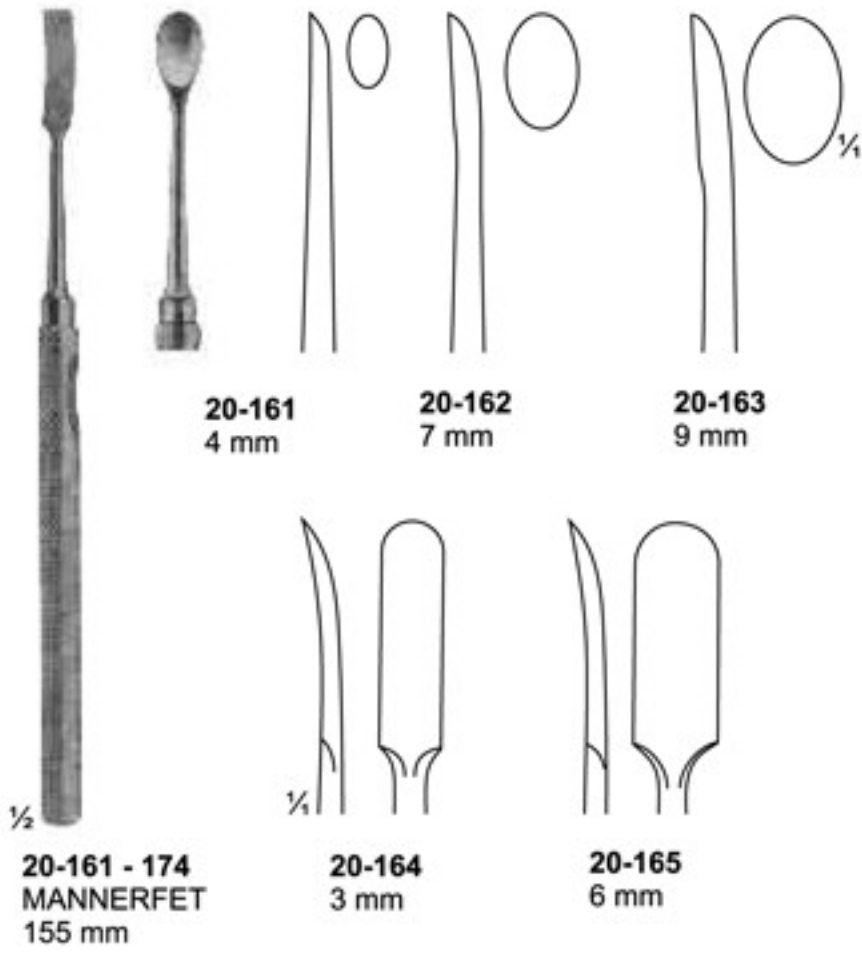

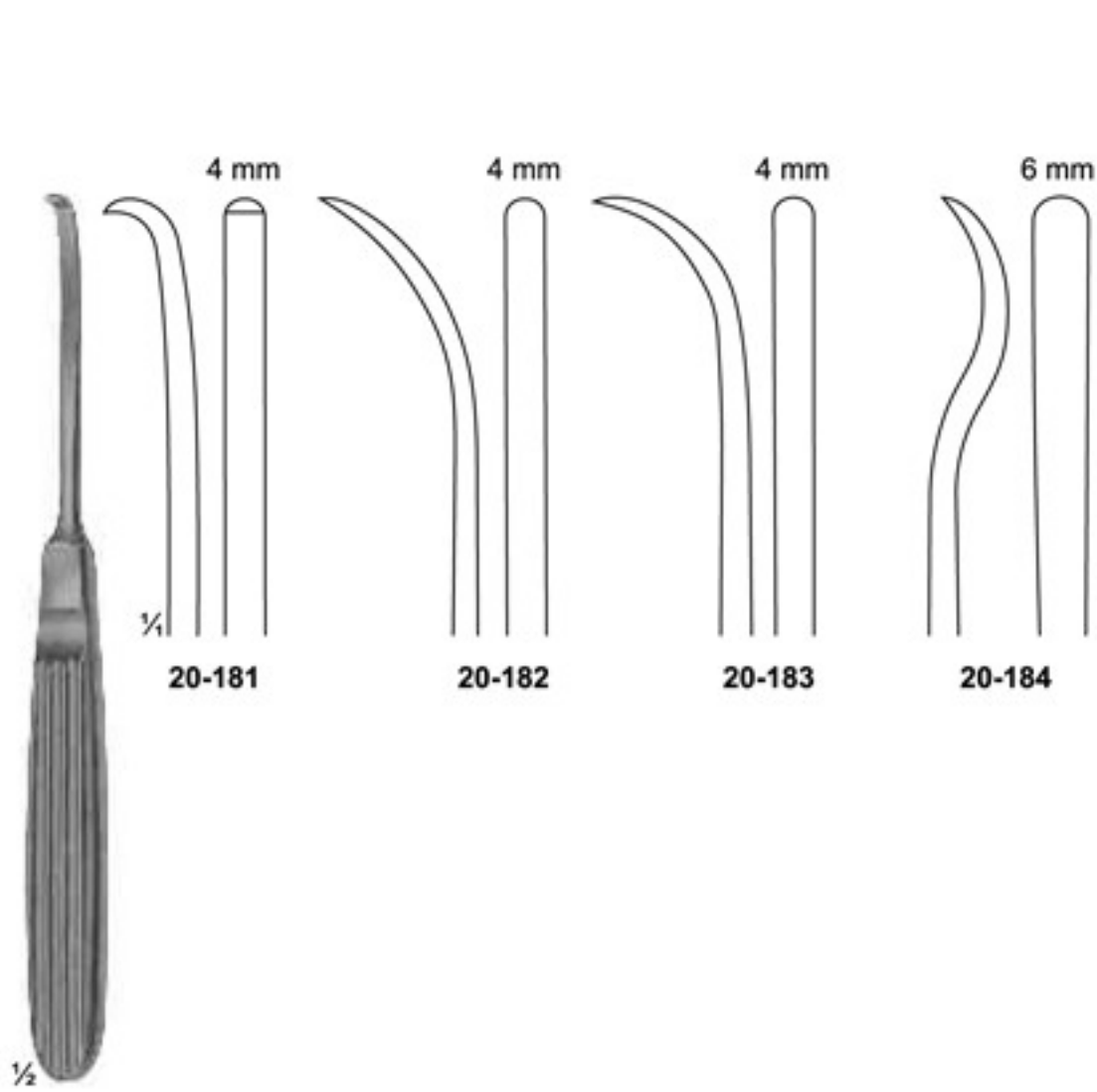

20-181 - 184
MUHLING
 170 mm

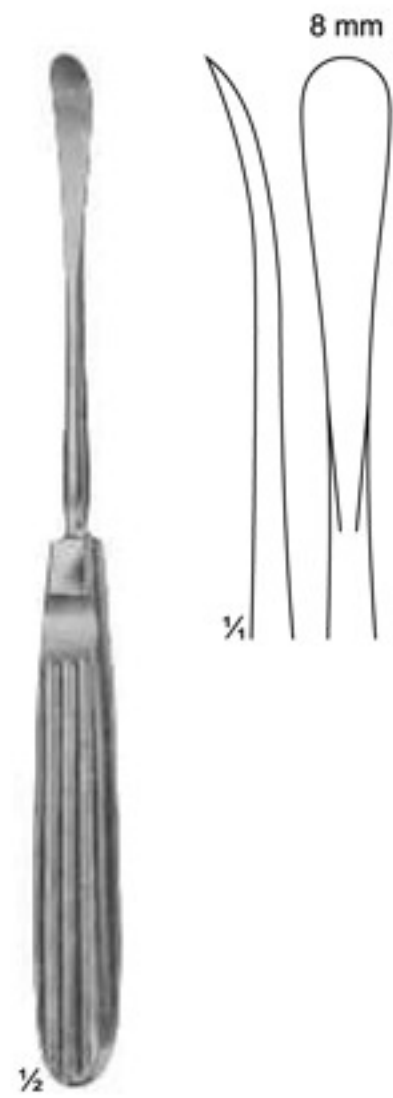

20-185
COTTLE
 175 mm

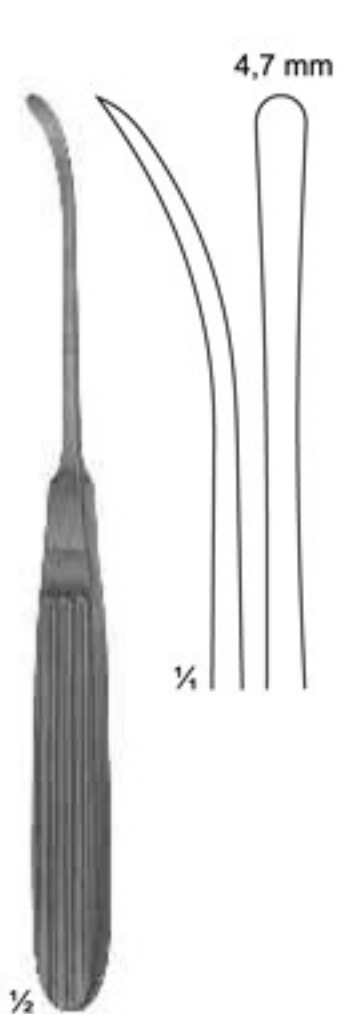

20-186
LANDOT
 175 mm

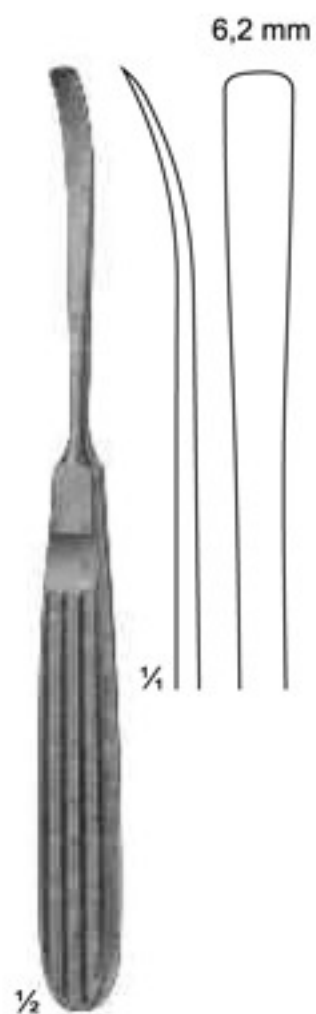

20-187
CASPER
 180 mm

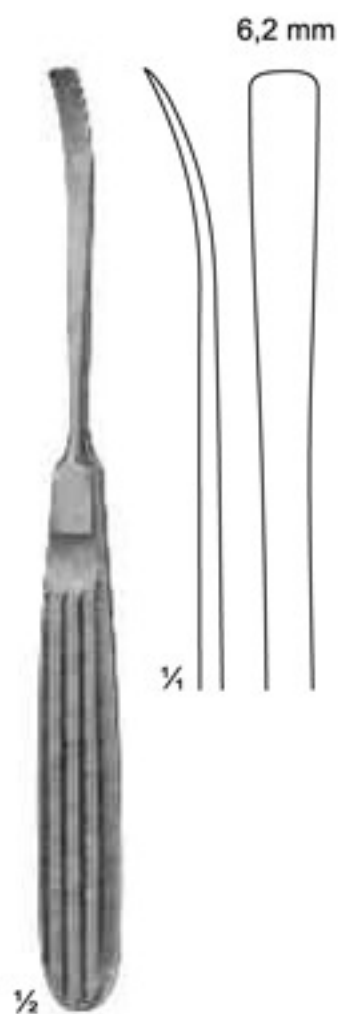

20-188
CASPER
 180 mm

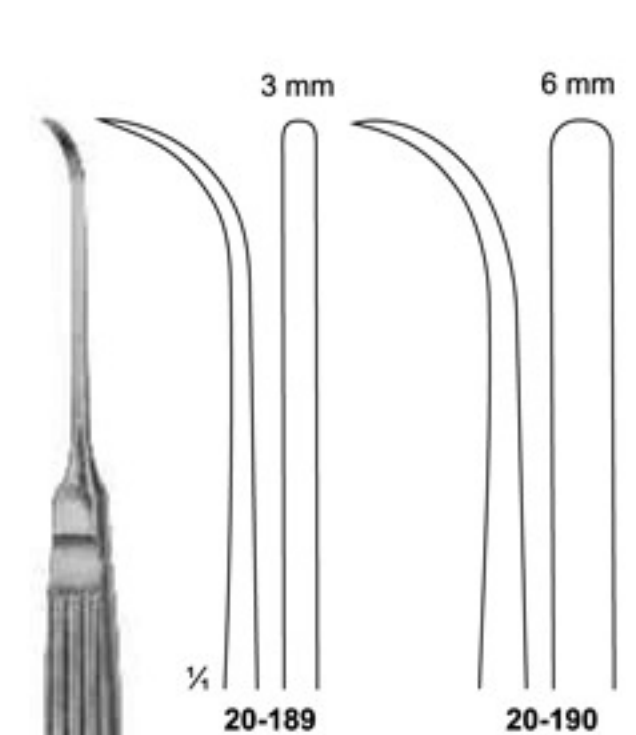

20-189 - 190
 170 mm

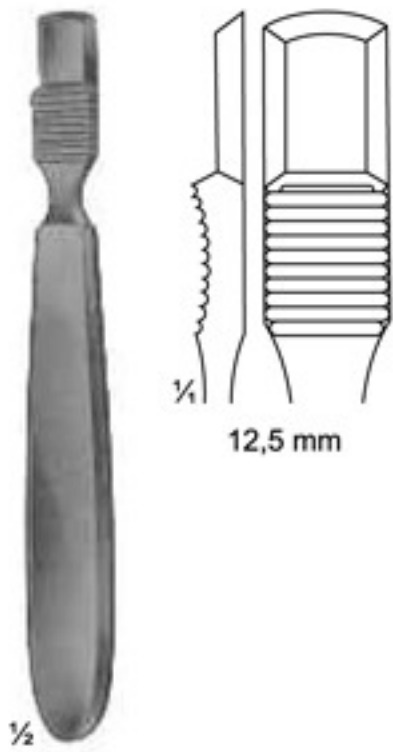

20-191
FARABEUF
140 mm

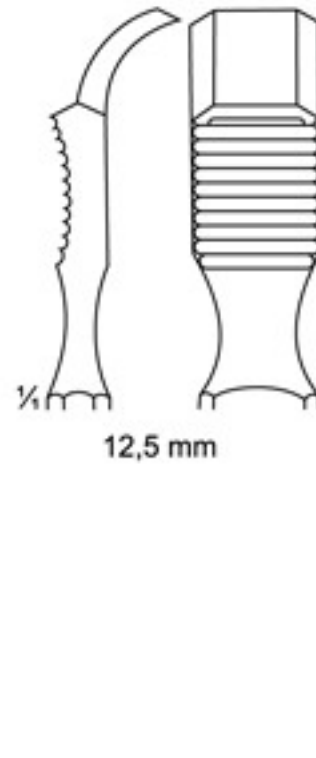

20-192
FARABEUF
140 mm

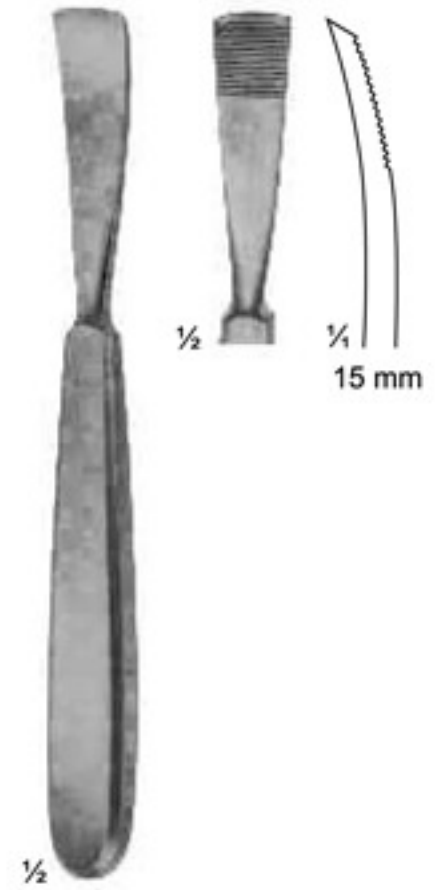

20-193
JANSEN
165 mm

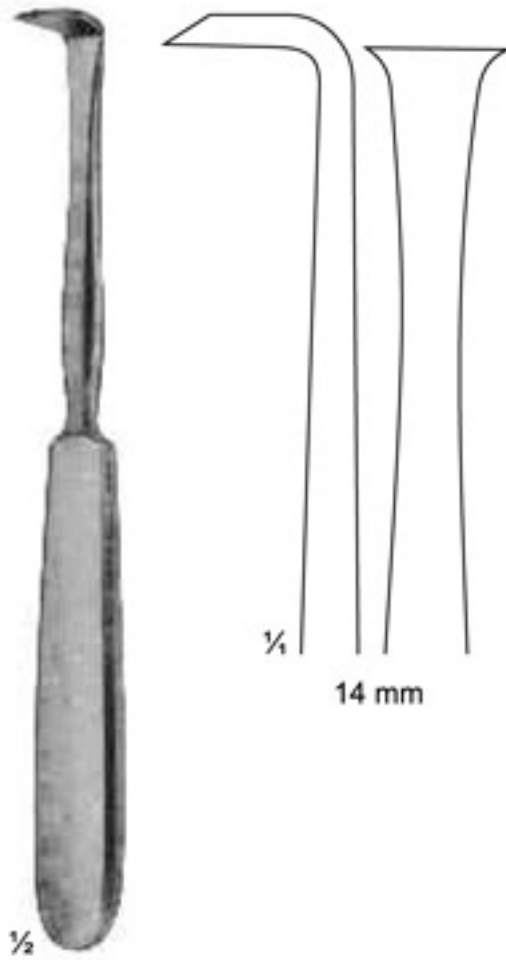

20-194
LANGENBACK
180 mm

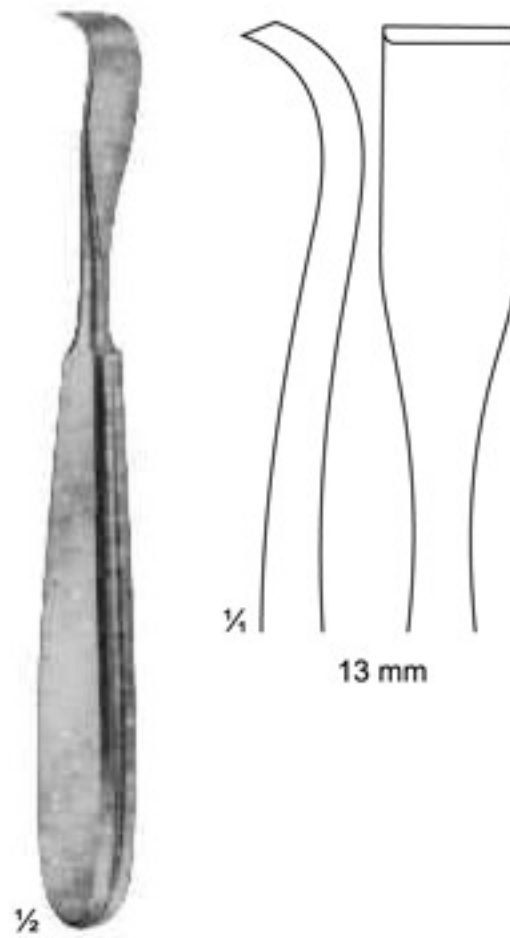

20-195
SCHNEIDER
175 mm

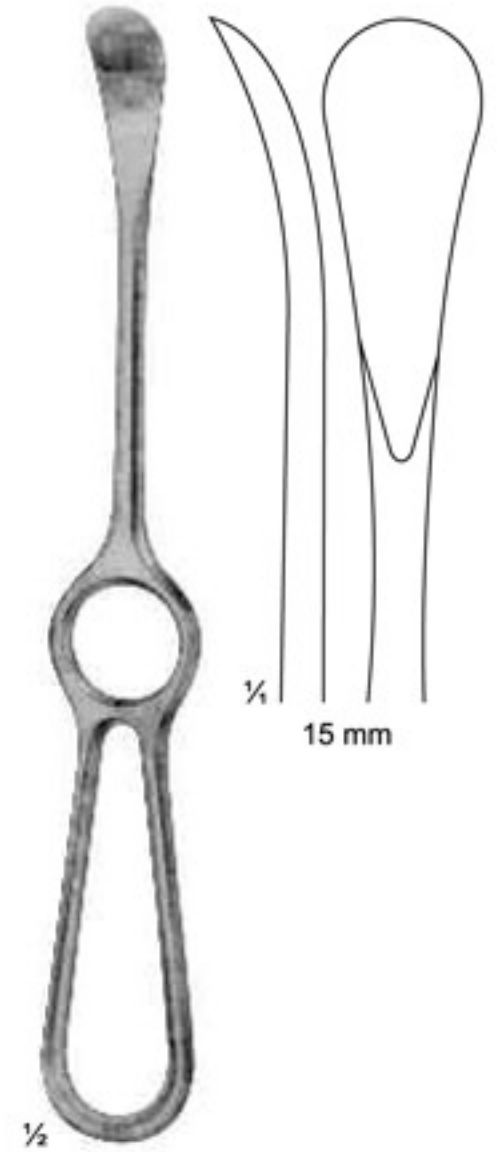

20-196
SEDILLOT
215 mm

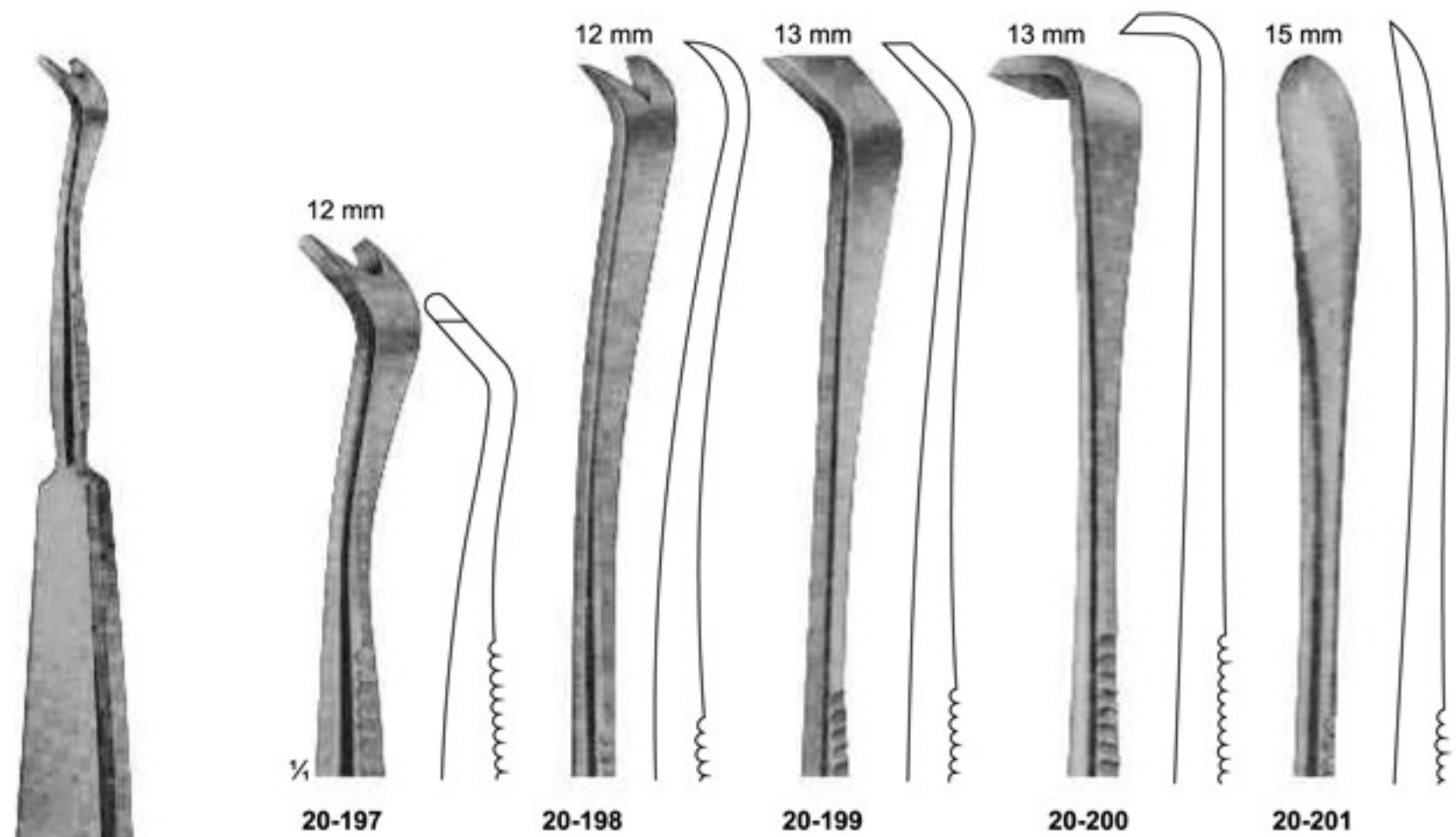

1/2
20-197 - 201
SEMB
230 mm



1/4
20-206
20-207

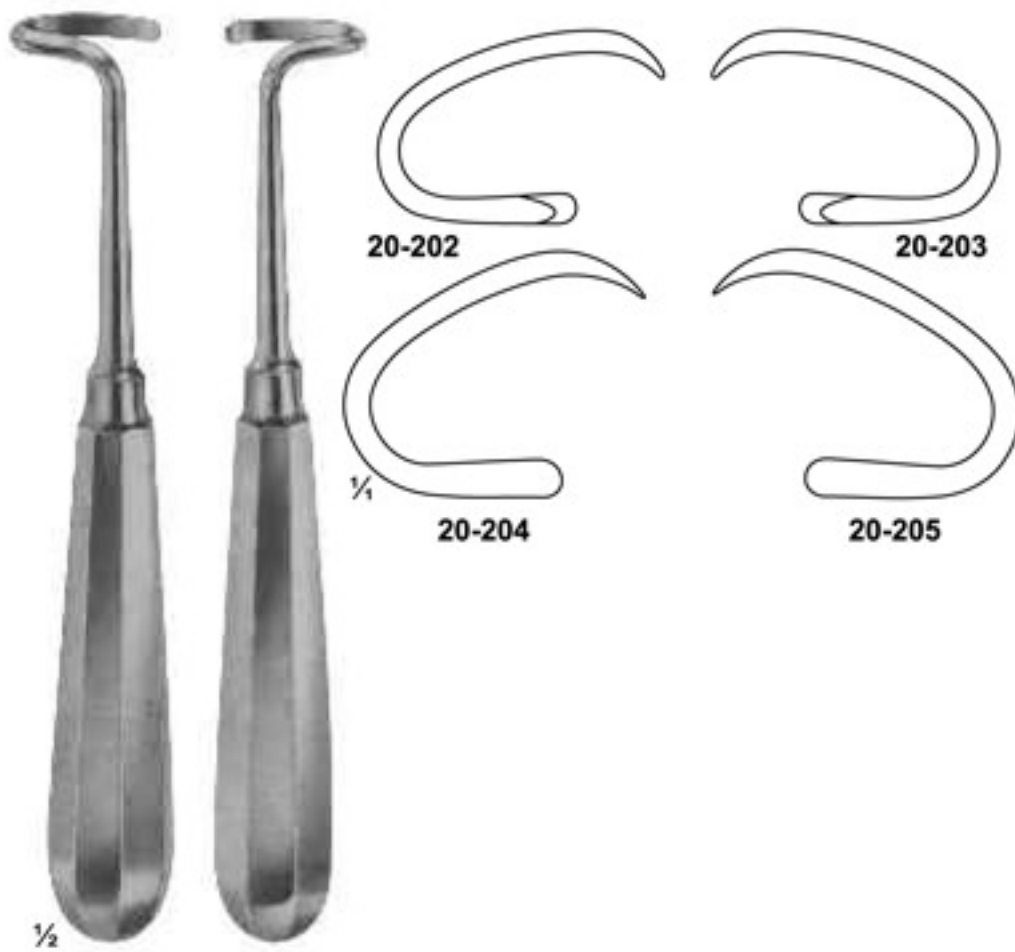

1/2
20-202 - 203
DOYEN
for children
20-204 - 205
for adults
175 mm

1/2
20-206 - 207
DOYEN
240 mm

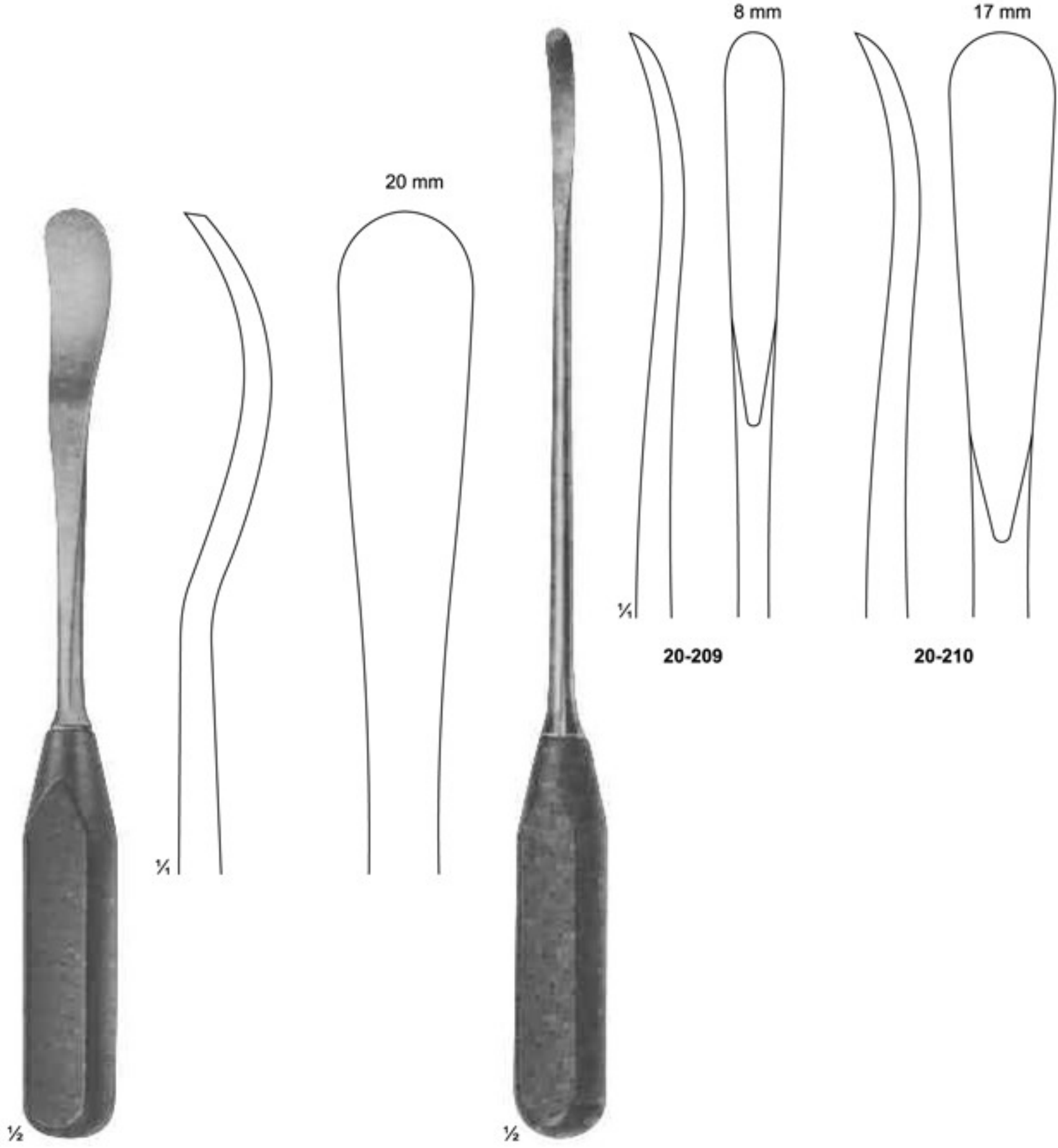

20-208
275 mm

20-209 - 210
WAGNER
330 mm

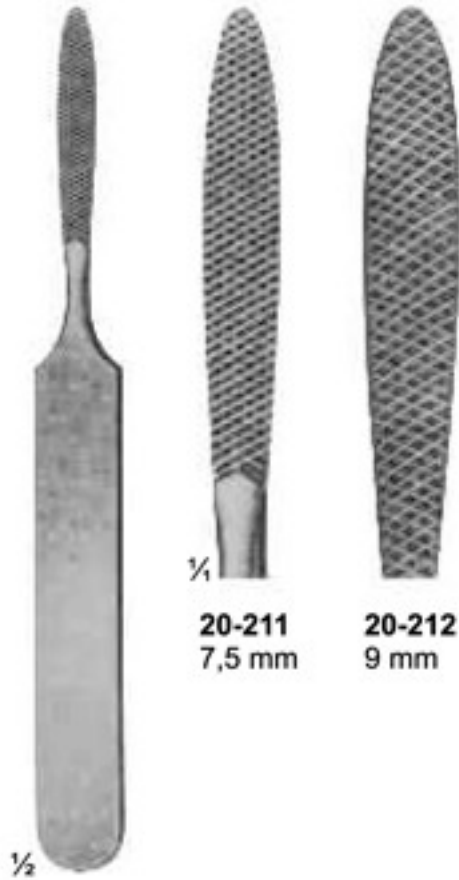

20-211
JOSEPH
fine, chequered

20-212
coarse, chequered
165 mm

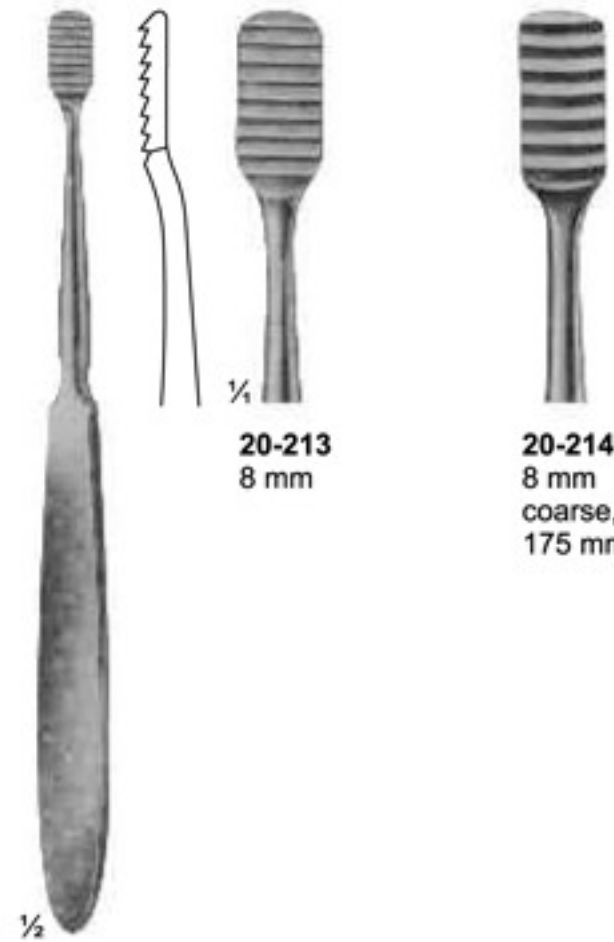

20-213
LEWIS
fine, teeth

20-214
8 mm
coarse, teeth
175 mm



20-215
MALTZ
down stroke
180 mm

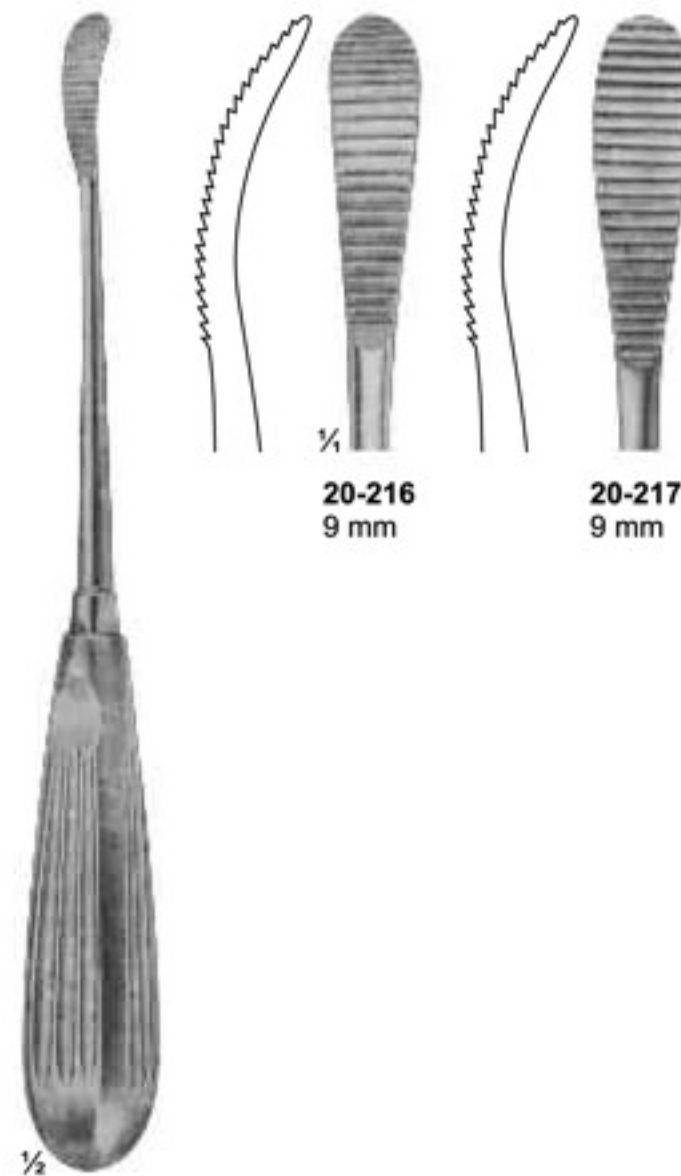

20-216
AUFRICHT
up stroke
20-217
down stroke
220 mm



20-218
GALLAHER
190 mm

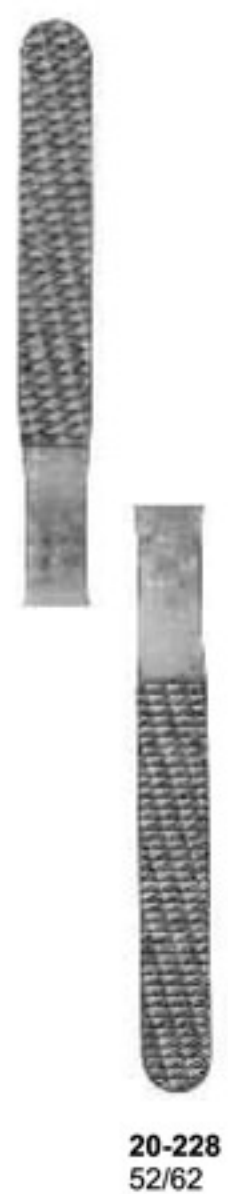
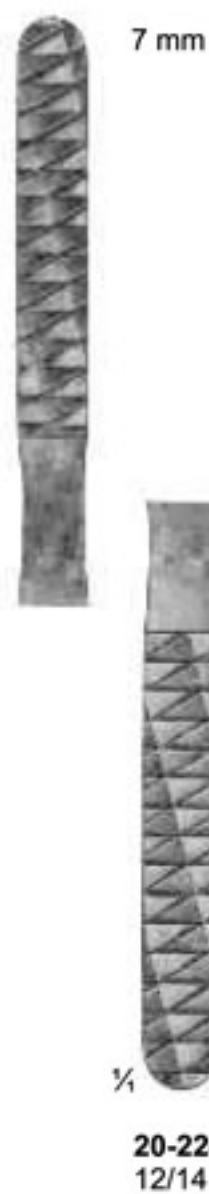
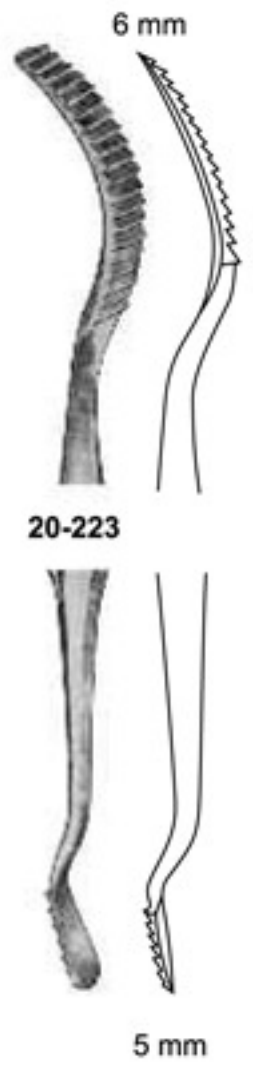
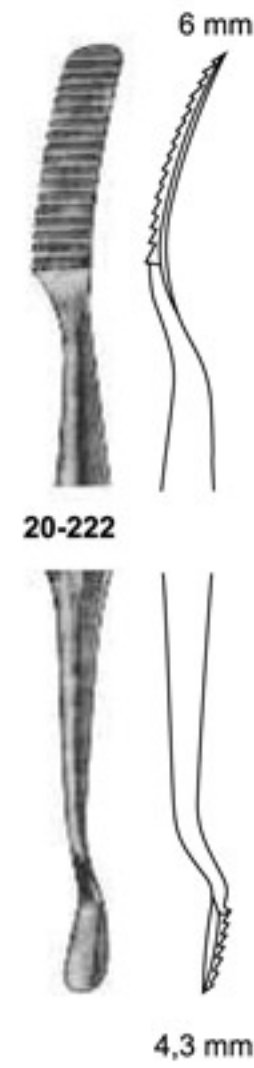
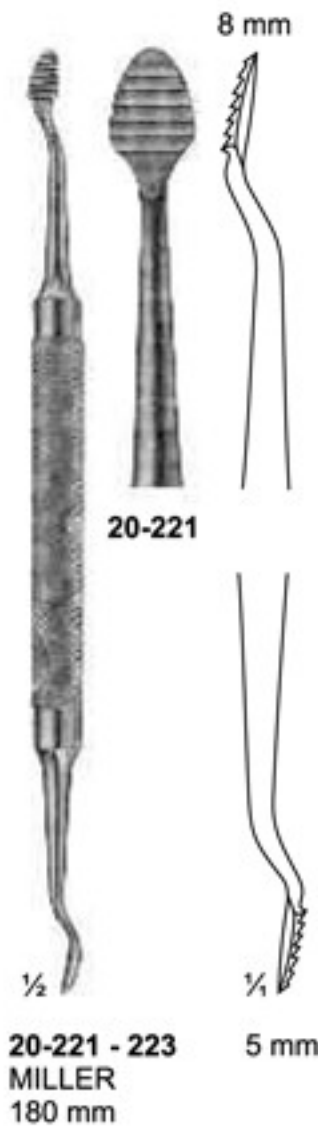
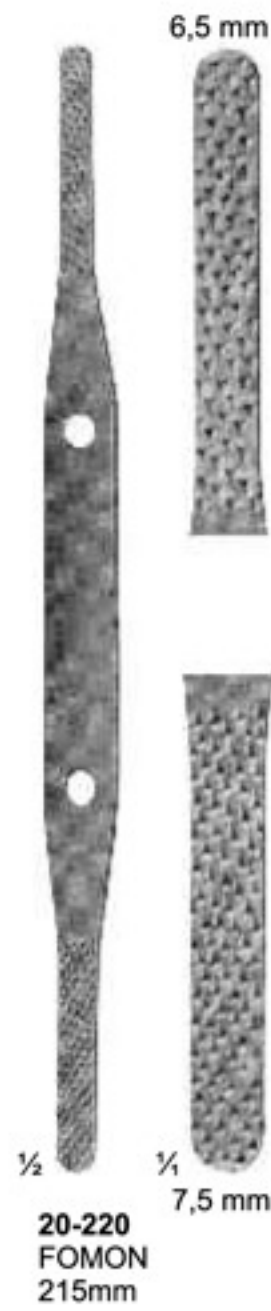
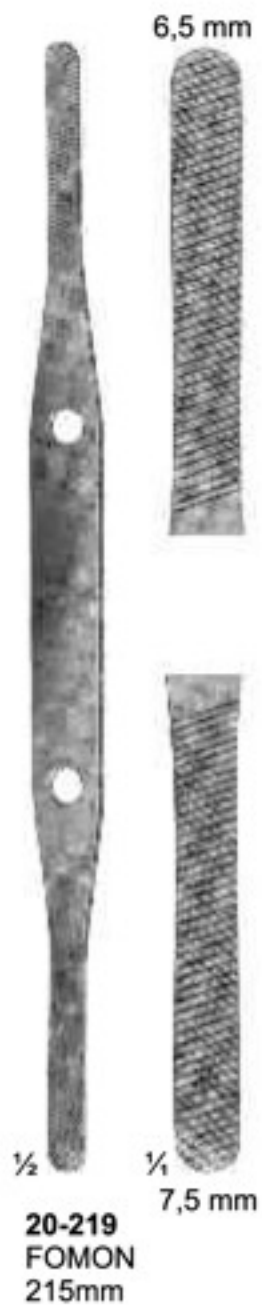

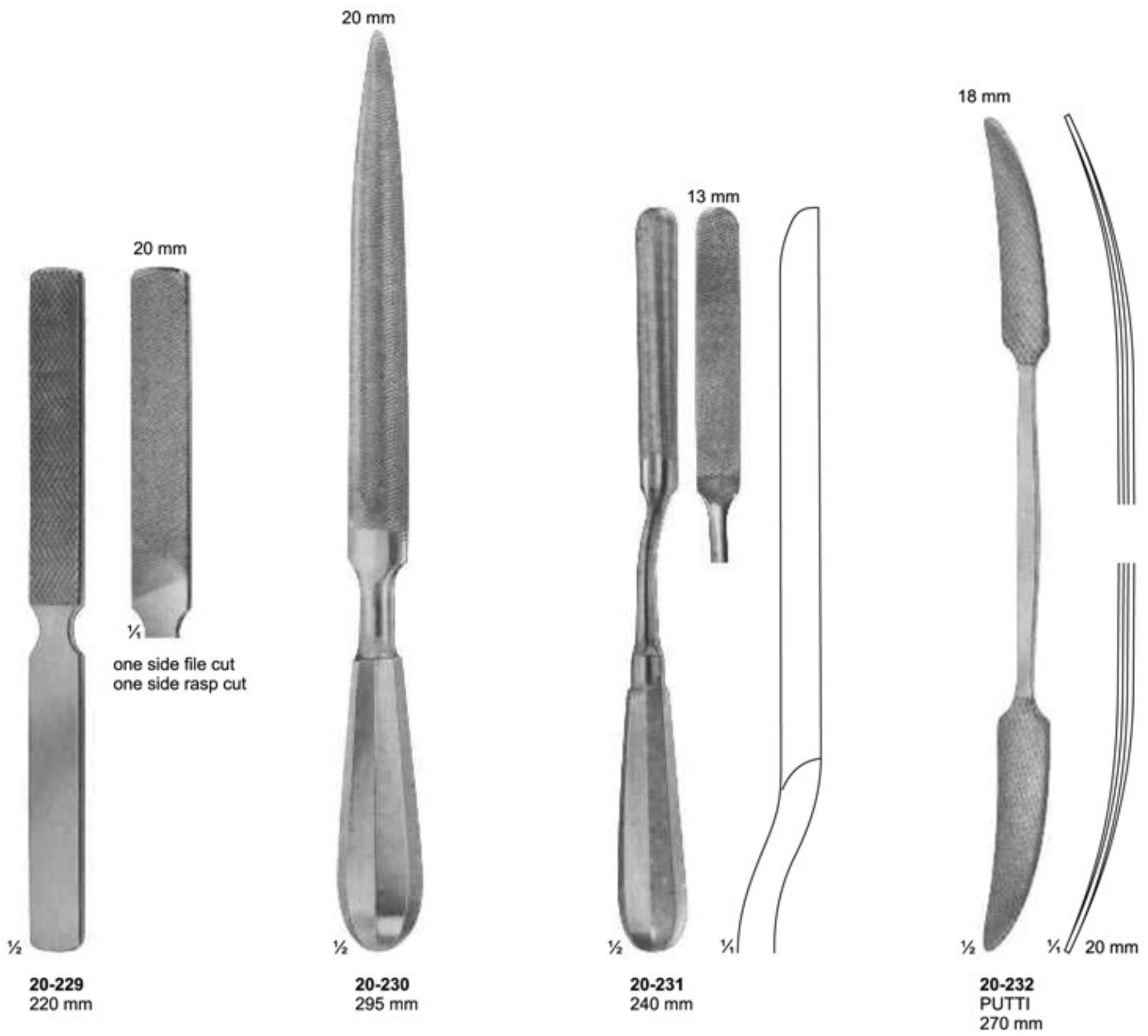



20-233
JACOBSON
140 mm

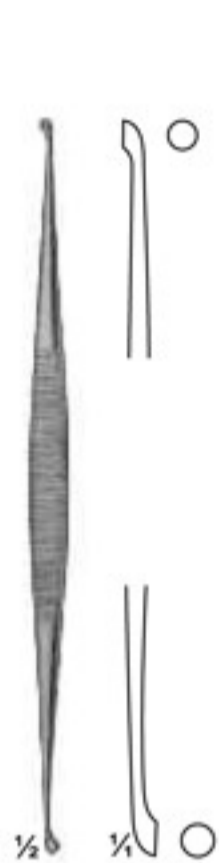

20-234
MARTINI
140 mm



20-235
MARTINI
140 mm



20-236
WILLIGER
145 mm



20-237
JANSEN
160 mm



20-238
BARTH
180 mm

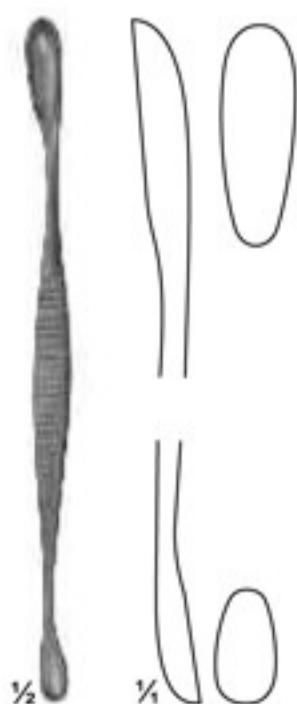

20-239
VOLKMANN
130 mm



20-240
VOLKMANN
145 mm

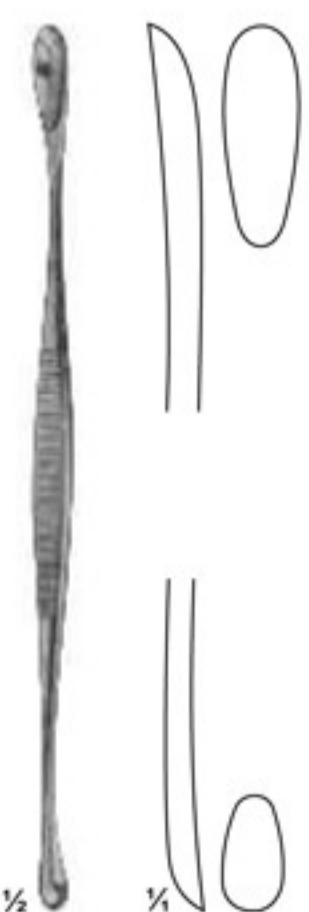

20-241
VOLKMANN
170 mm



20-242
JANSEN
160 mm



20-243
HEMINGWAY
170 mm



20-244
HEMINGWAY
175 mm

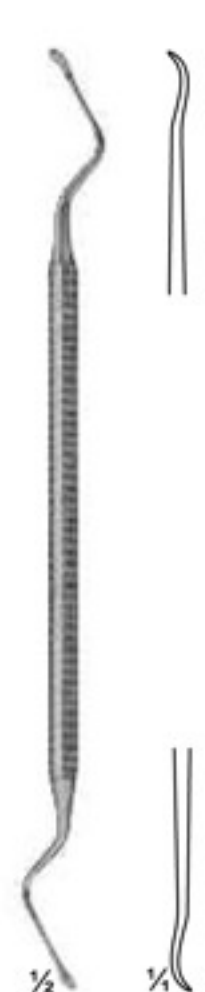

20-245
LUCAS
180 mm

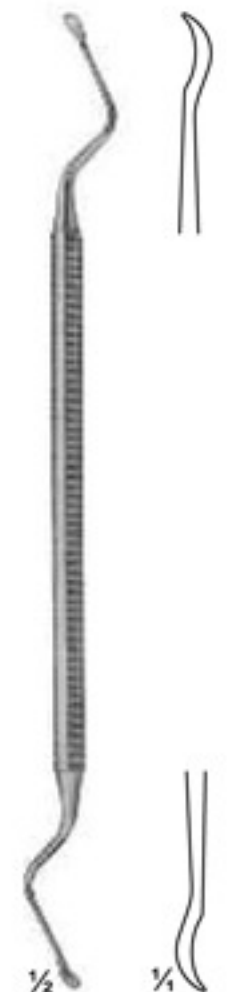

20-246
LUCAS
185 mm

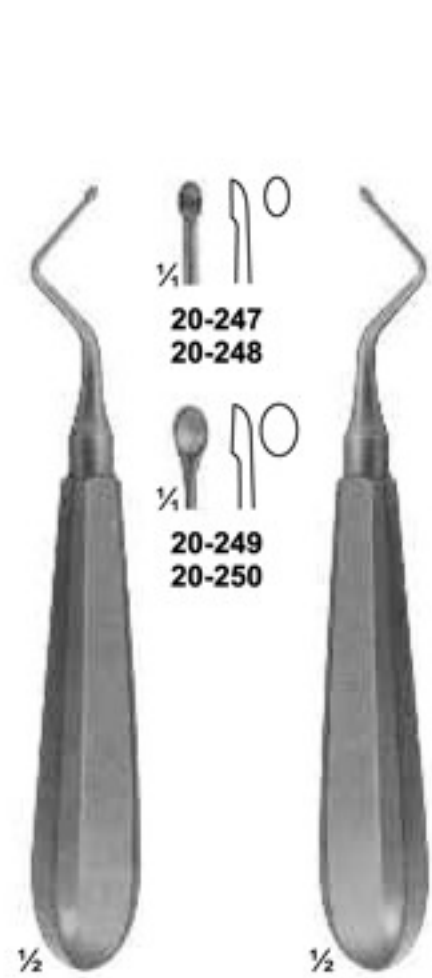

20-247 - 248
KERPEL
145 mm

20-249 - 250
KERPEL
145 mm

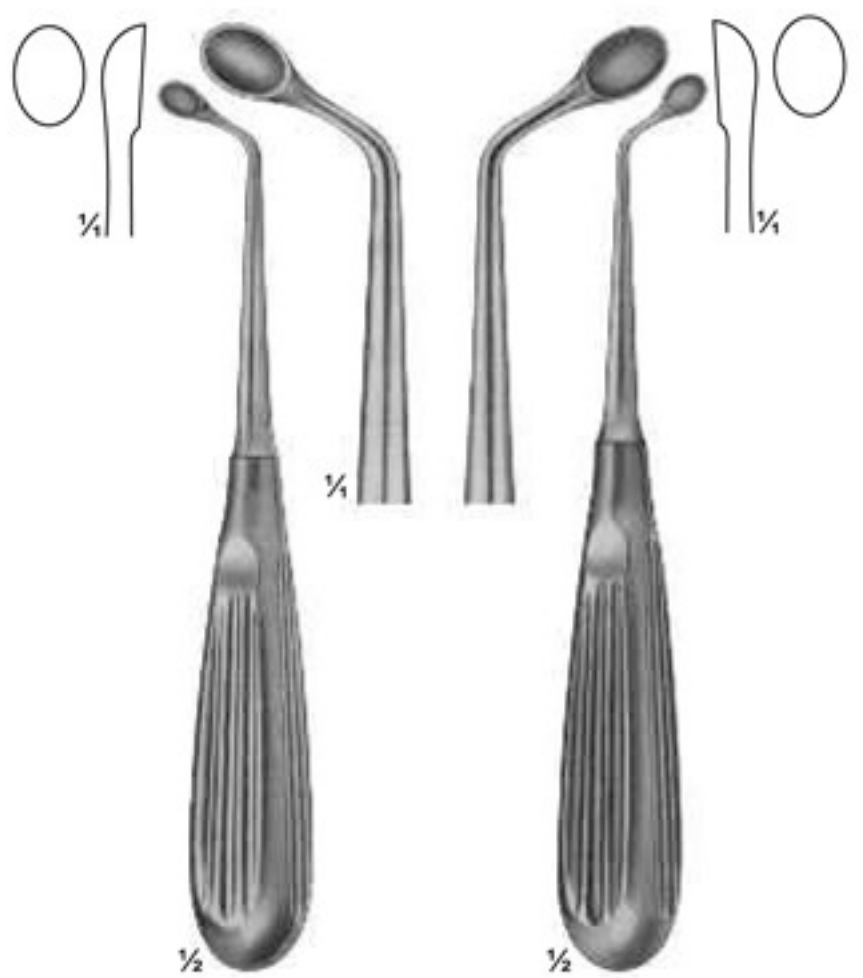

20-251
UFFENORDE
170 mm

20-252
UFFENORDE
170 mm



½

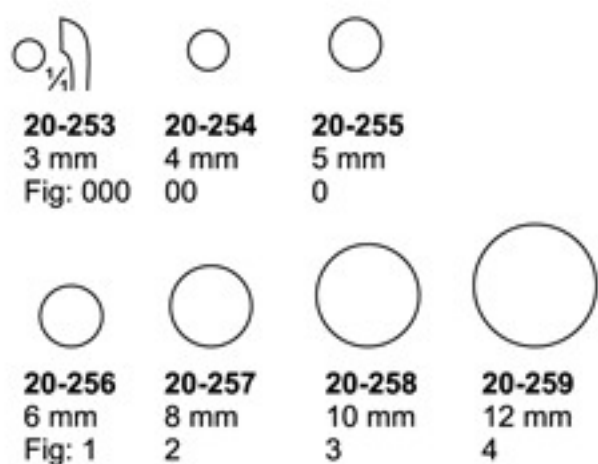

20-253 - 259
BRUNS
165 mm



½

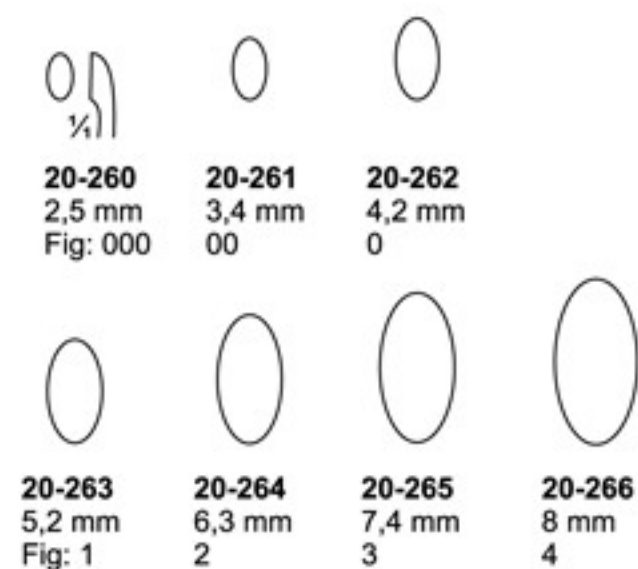

20-260 - 266
SCHEDE
170 mm



½

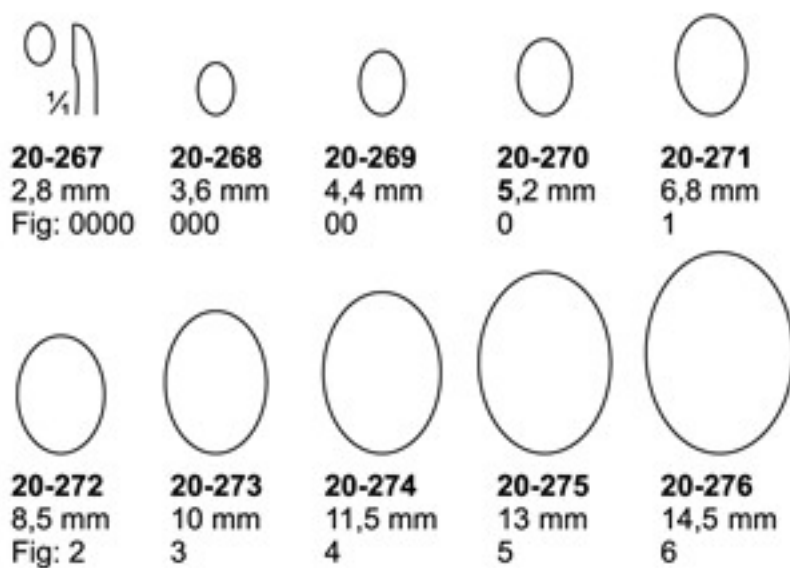

20-267 - 276
VOLKMANN
170 mm



½

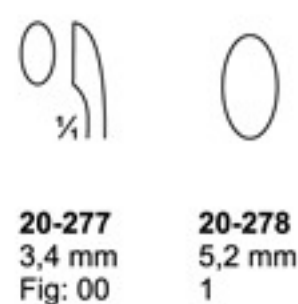

20-277 - 278
WILLIGER
170 mm

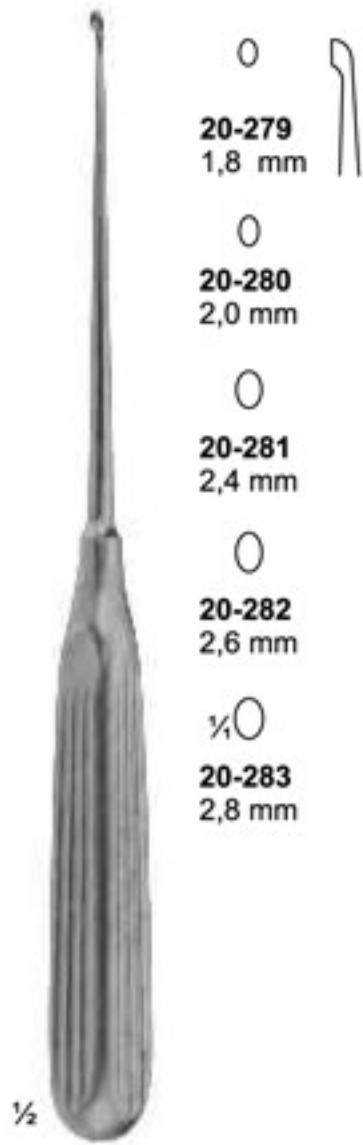

20-279
1,8 mm

20-280
2,0 mm

20-281
2,4 mm

20-282
2,6 mm

20-283
2,8 mm

20-279 - 283
LEMPERT
215 mm

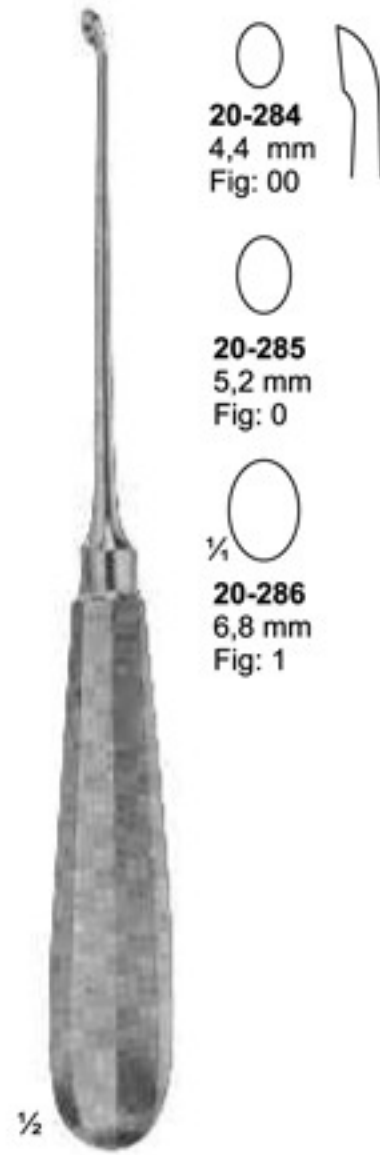

20-284
4,4 mm
Fig: 00

20-285
5,2 mm
Fig: 0

20-286
6,8 mm
Fig: 1

20-284 - 286
HALLE
215 mm

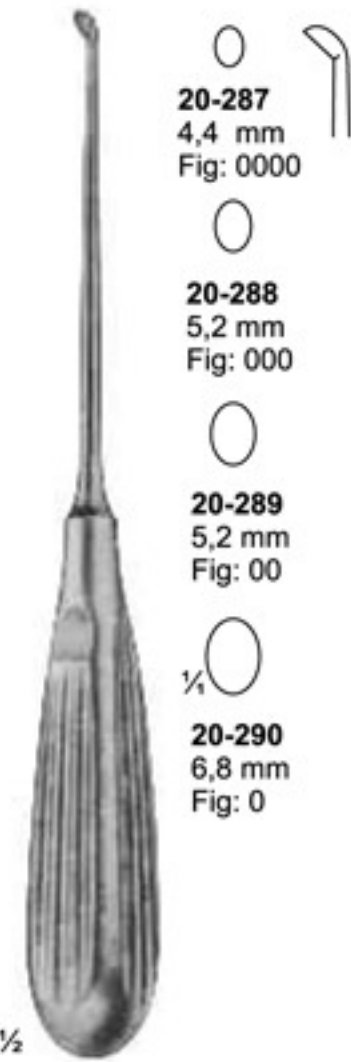

20-287
4,4 mm
Fig: 0000

20-288
5,2 mm
Fig: 000

20-289
5,2 mm
Fig: 00

20-290
6,8 mm
Fig: 0

20-287 - 290
DAUBENSPECK
200 mm



20-291
3,6 mm
Fig: 000

20-292
4,4 mm
Fig: 00

20-293
5,2 mm
Fig: 0

20-294
6,8 mm
Fig: 1

20-291 - 294
250 mm



20-295
3,6 mm
Fig: 000

20-296
4,4 mm
Fig: 00

20-297
5,2 mm
Fig: 0

20-298
6,8 mm
Fig: 1

20-295 - 298
250 mm



20-299
3 mm

20-300
4 mm

20-301
5 mm

20-299 - 301
BUSHE
250 mm

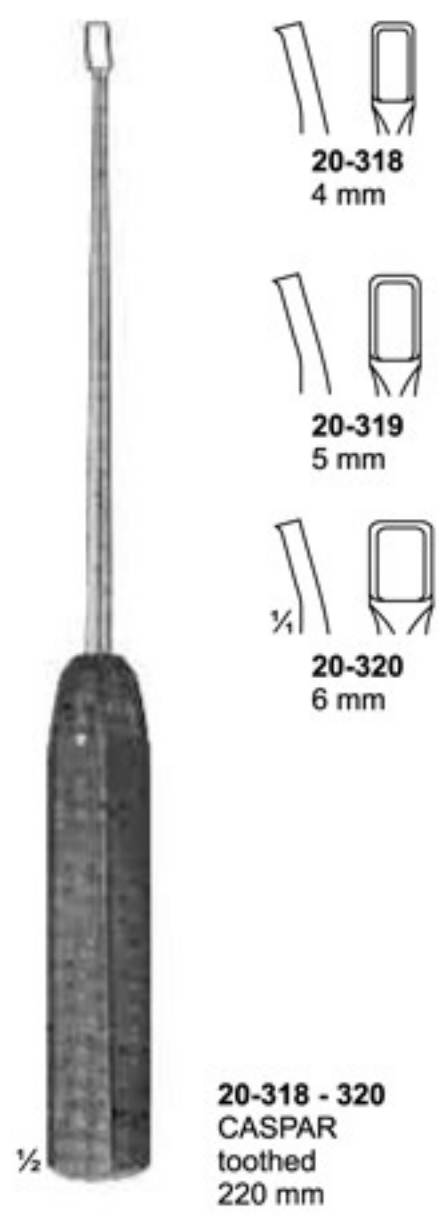
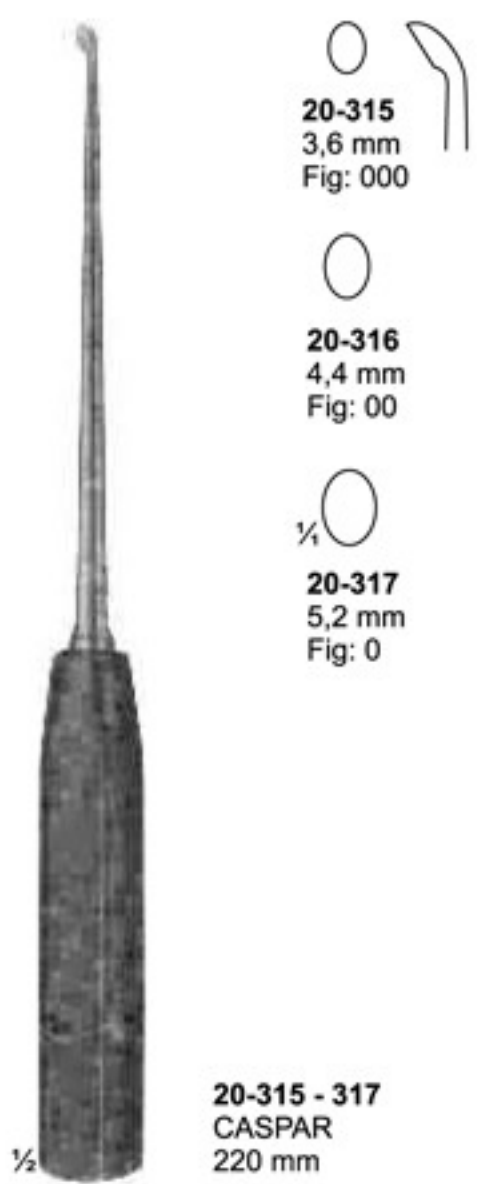
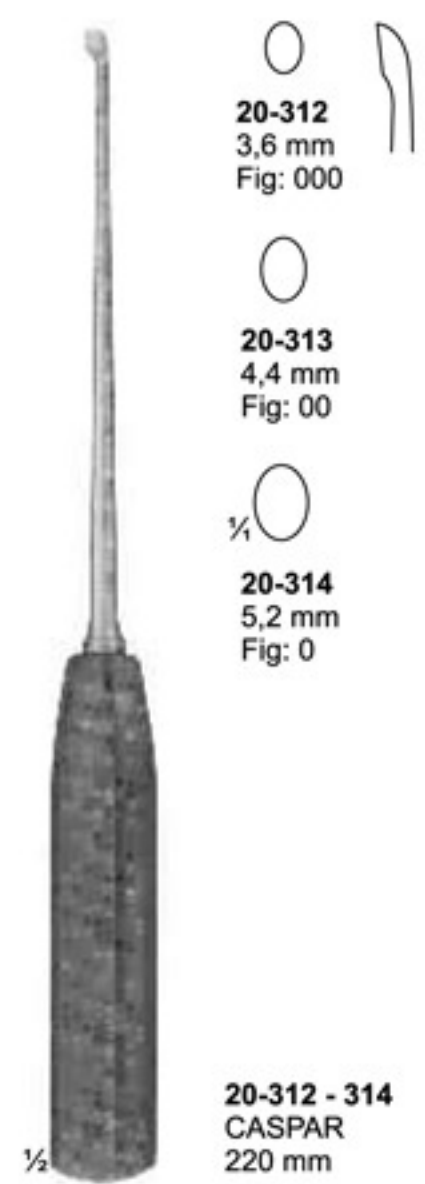
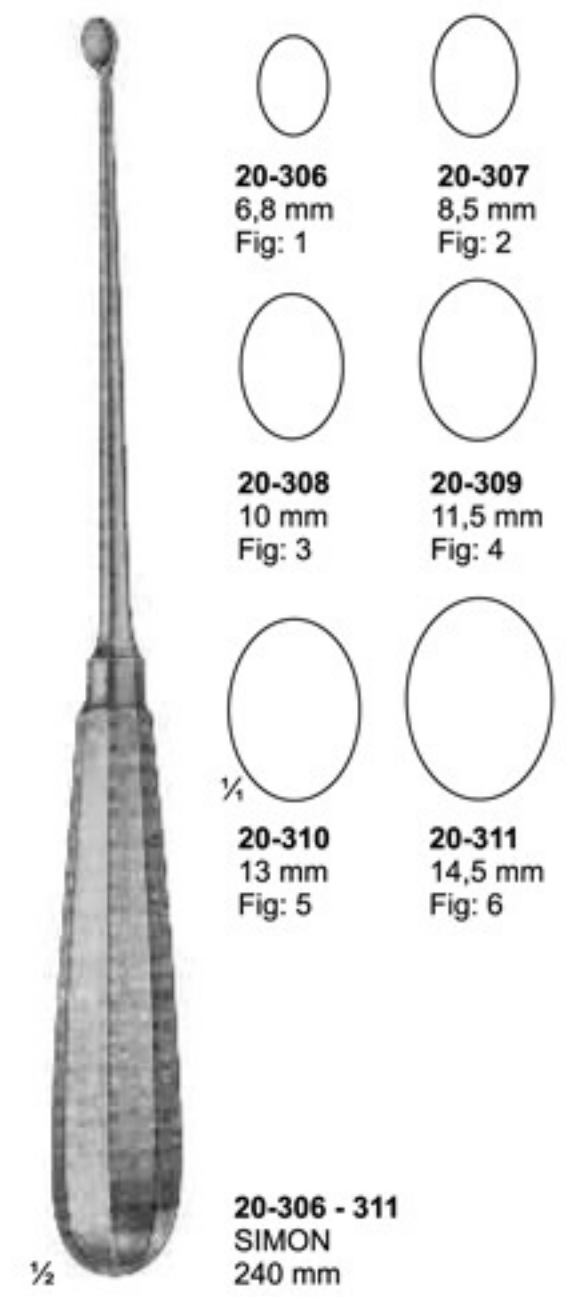
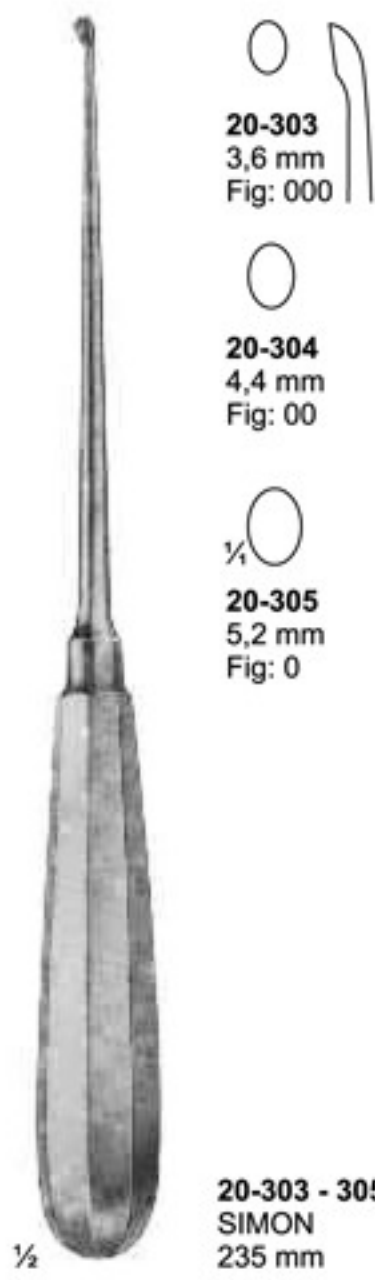

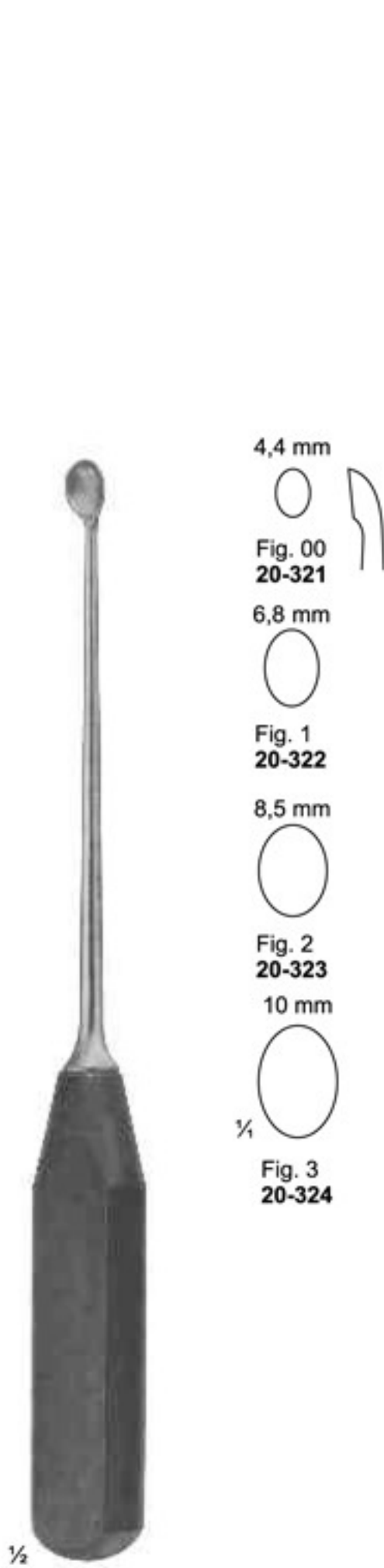

20-321 - 324
270 mm

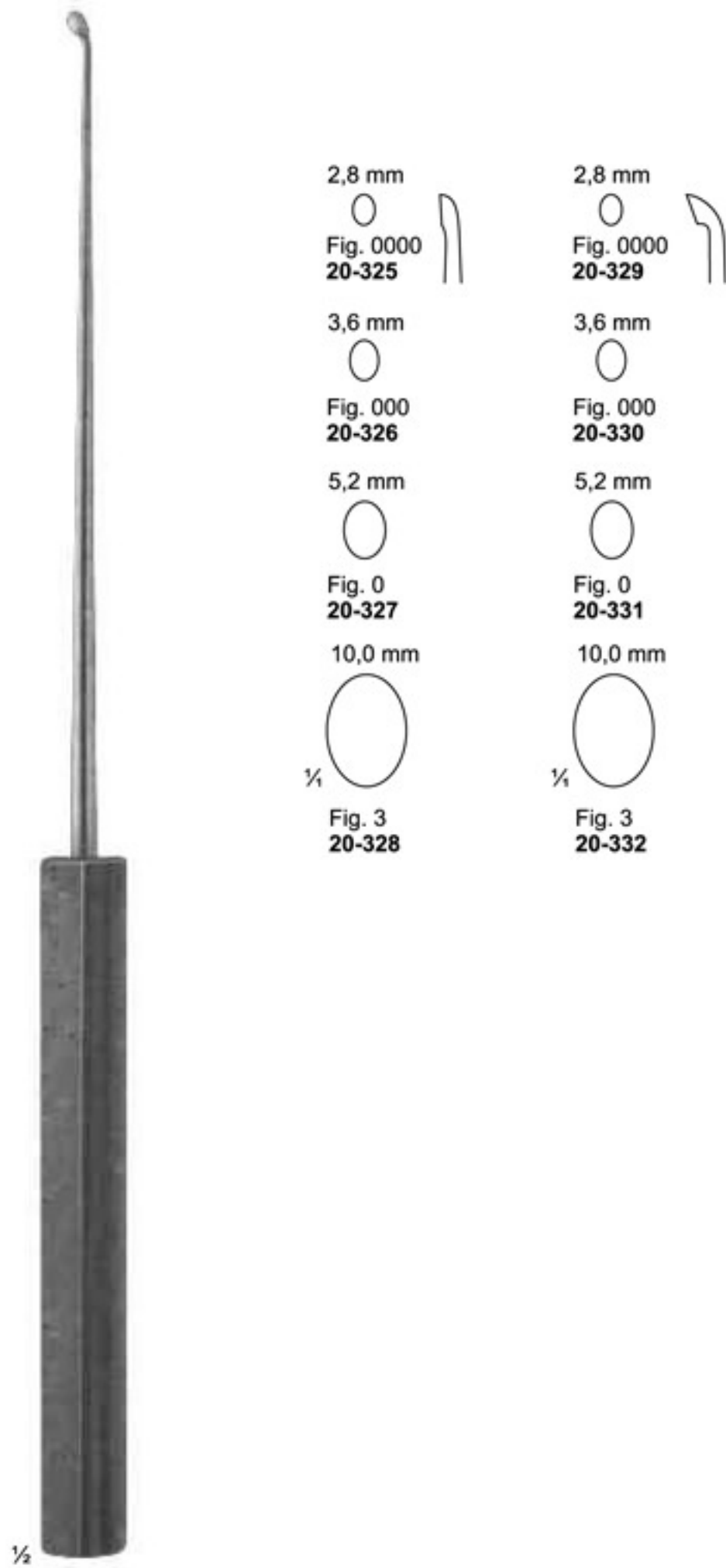

20-325 - 332
SYPERT
380 mm



∅20 mm

½

21-101
MEAD
185 g
with interchangeable
plastic disks
190 mm
21-102
pair of spare disks



½

21-103
140 g
with interchangeable
plastic disks
185 mm
21-104
pair of spare disks



∅25 mm

½

21-105
COTTLE
140 g
1 Seite convex
1 Side convex
185 mm



∅22 mm

½

21-106
165 g
lead filled head
190 mm



∅ 27 mm

½

21-107
HAJEK
140 g
215 mm



∅ 30 mm

½

21-108
215 g
with interchangeable
plastic disks
245 mm
21-109
pair of spare disks



∅ 35 mm

½

21-110 - 113
WAGNER
complete with:
1 pair of metal disks and
1 pair of plastic disks and
1 wrench 566
235 mm

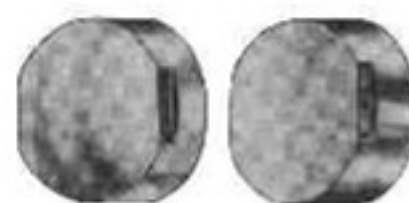

21-111
1 metal disks, flat
1 metal disks, convex

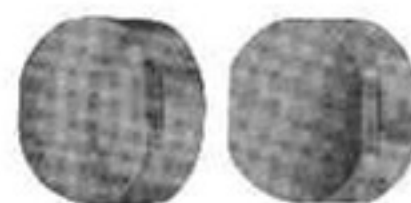

21-112
1 plastic disks, flat
1 plastic disks, convex

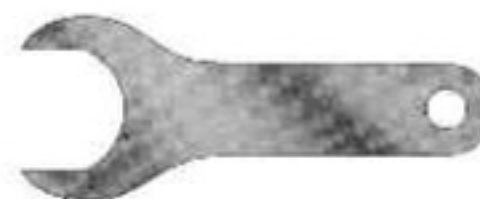

21-113
Wrench

Mallet without disks 130 g



21-114
BERGMANN
245 mm



21-115
BERGMANN
235 mm



21-116
OMBREDANNE
240 mm



21-117
HEATH
copper filled head
700 g
185 mm

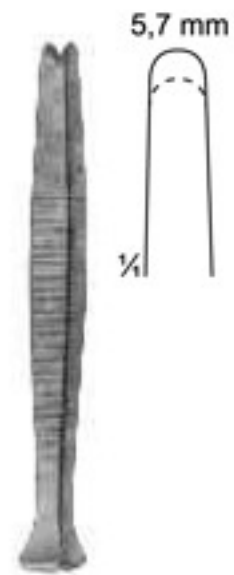

21-118
Haase
100 mm

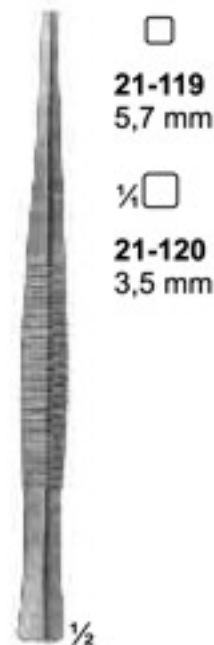

21-119 - 120
PASSOW
120 mm



21-121 - 123
CASPER
200 mm



21-124 - 126
200 mm

- 21-121
ø3 mm
- 21-122
ø5 mm
- 21-123
ø8 mm

- 21-124
ø12 mm
- 21-125
ø14 mm
- 21-126
ø16 mm

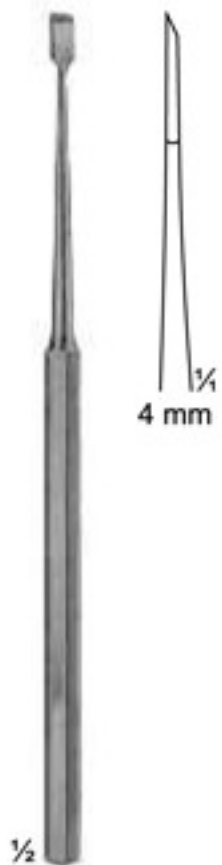

21-127
FREER
Chisel
160 mm

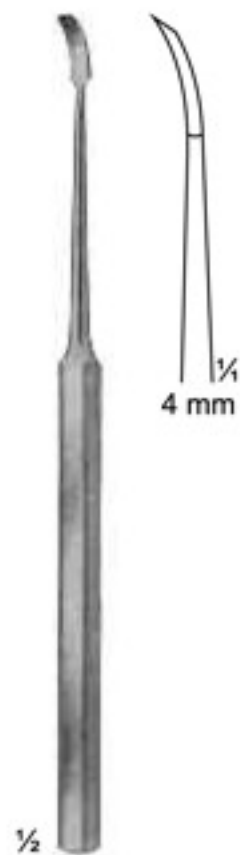

21-128
FREER
Chisel, curved
160 mm

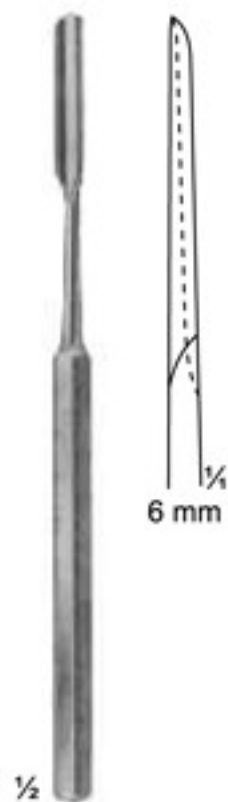

21-129
FREER
Gouge
150 mm

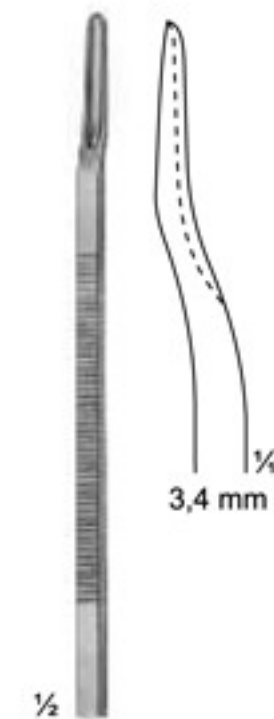

21-130
Scaphoid gouge,
downwards curved
135 mm

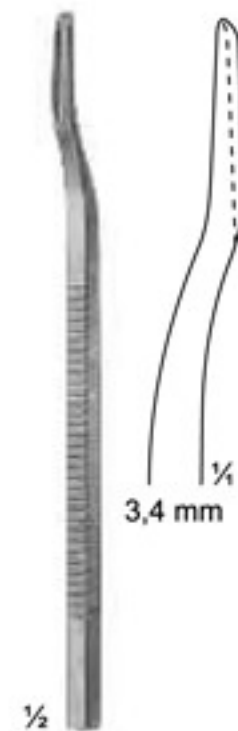

21-131
Scaphoid gouge,
upwards curved
135 mm



21-131A - 133
Mannerfelt
21-131A 4 mm
21-132 6 mm
21-133 8 mm
155 mm

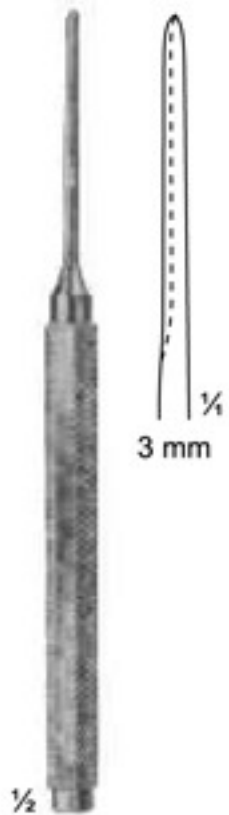

21-134
Mannerfelt
155 mm

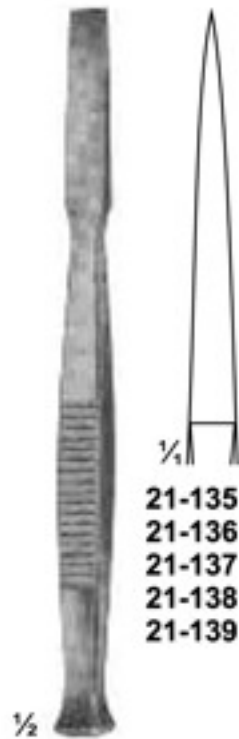

21-135 - 139
Osteotome
140 mm

- 21-135 4 mm
- 21-136 6 mm
- 21-137 8 mm
- 21-138 10 mm
- 21-139 12 mm

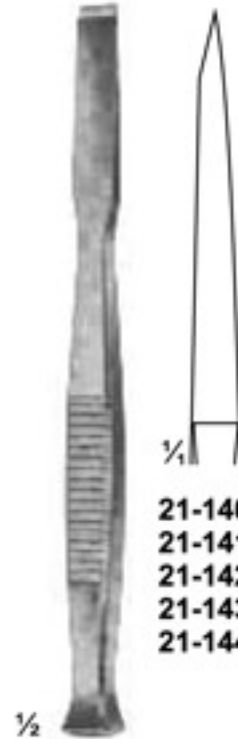

21-140 - 144
Chisels
140 mm

- 21-140 4 mm
- 21-141 6 mm
- 21-142 8 mm
- 21-143 10 mm
- 21-144 12 mm

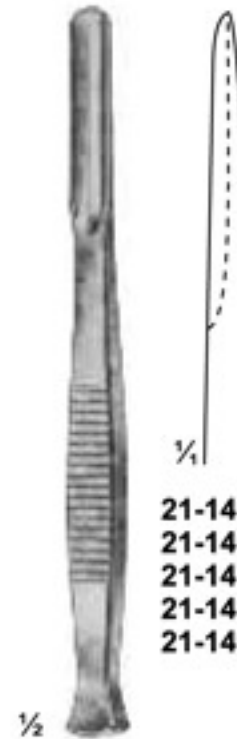

21-145 - 149
Gouges
140 mm

- 21-145 4 mm
- 21-146 6 mm
- 21-147 8 mm
- 21-148 10 mm
- 21-149 12 mm

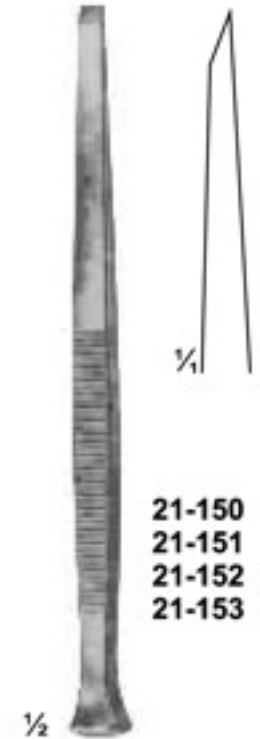

PARTSCH
21-150 - 153
Chisels
140 mm

- 21-150 3 mm
- 21-151 4 mm
- 21-152 5 mm
- 21-153 6 mm

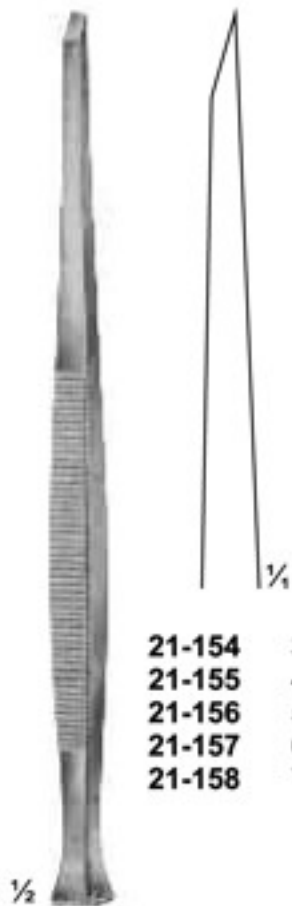

PARTSCH
21-154 - 158
Chisels
170 mm

- 21-154 3 mm
- 21-155 4 mm
- 21-156 5 mm
- 21-157 6 mm
- 21-158 7 mm

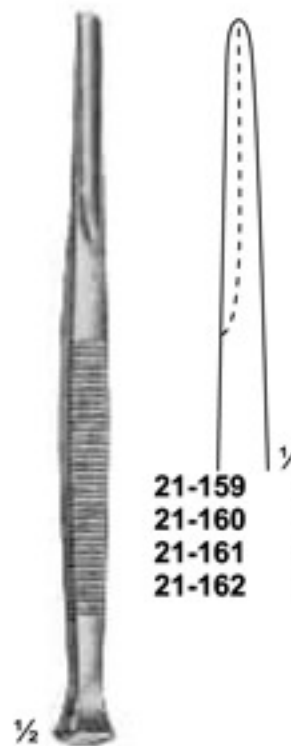

PARTSCH
21-159 - 162
Gouges
140 mm

- 21-159 3 mm
- 21-160 4 mm
- 21-161 5 mm
- 21-162 6 mm

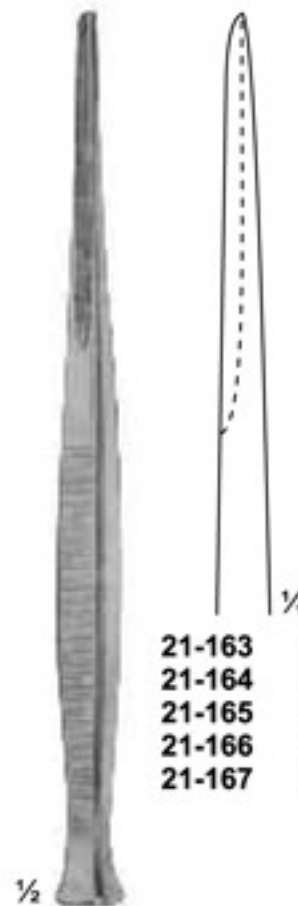

PARTSCH
21-163 - 167
Gouges
170 mm

- 21-163 3 mm
- 21-164 4 mm
- 21-165 5 mm
- 21-166 6 mm
- 21-167 7 mm



LUCAS
21-168 - 169
Chisels
160 mm

- 21-168 4 mm
- 21-169 6 mm

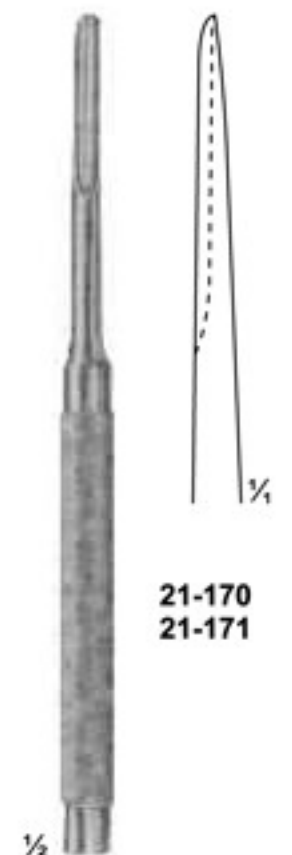

LUCAS
21-170 - 171
Gouges
160 mm

- 21-170 3 mm
- 21-171 5 mm

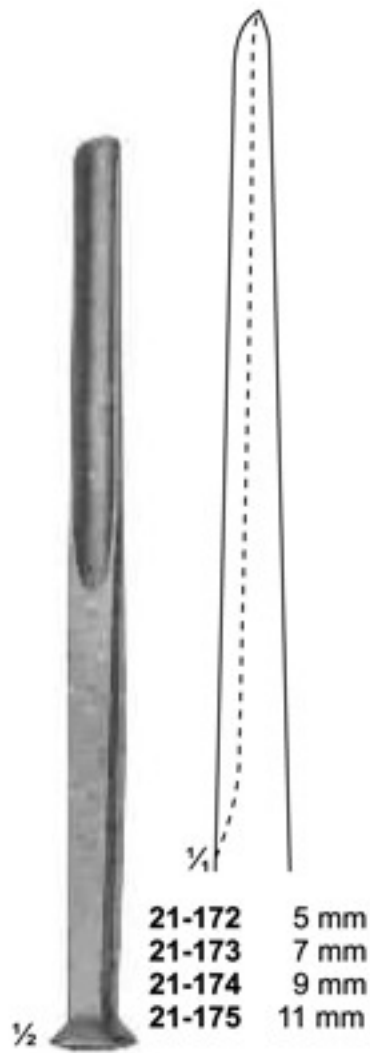

21-172 5 mm
21-173 7 mm
21-174 9 mm
21-175 11 mm

ALEXANDER
21-172 - 175
Gouges
170 mm

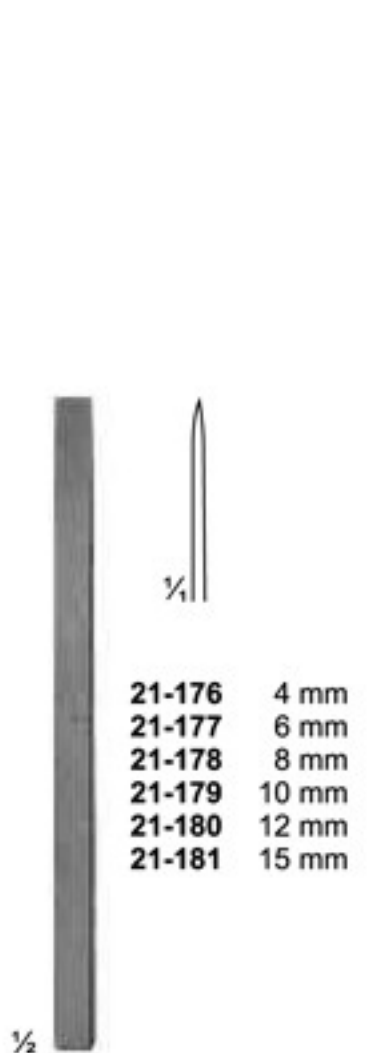

21-176 4 mm
21-177 6 mm
21-178 8 mm
21-179 10 mm
21-180 12 mm
21-181 15 mm

LAMBOTTE
21-176 - 181
Osteotome
125 mm

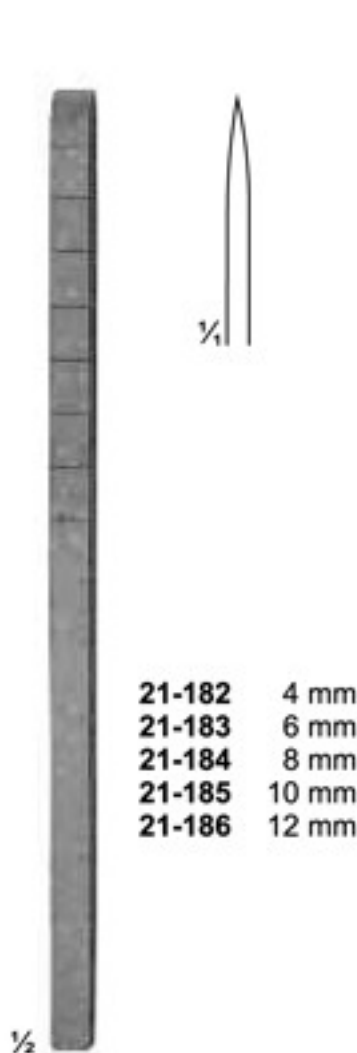

21-182 4 mm
21-183 6 mm
21-184 8 mm
21-185 10 mm
21-186 12 mm

COTTLE
21-182 - 186
Osteotome with depth
markings
180 mm

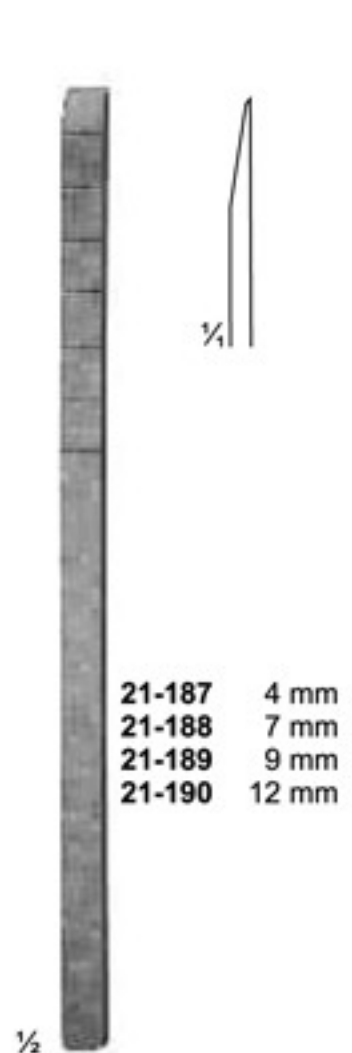

21-187 4 mm
21-188 7 mm
21-189 9 mm
21-190 12 mm

COTTLE
21-187 - 190
Chisel-Osteotomes
with depth markings
180 mm

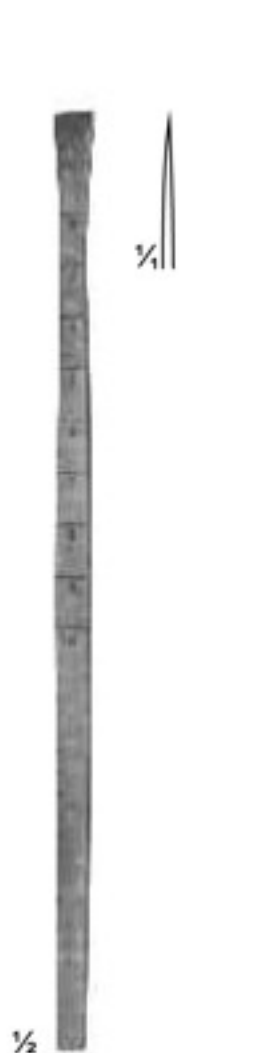

COTTLE
21-191
Fishtail Chisel,
with protected ends
180 mm

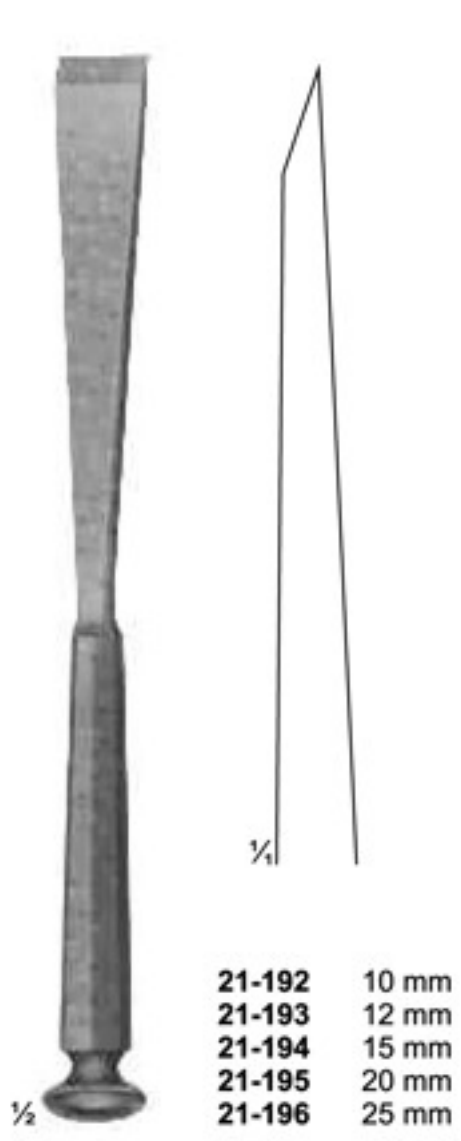

21-192 10 mm
21-193 12 mm
21-194 15 mm
21-195 20 mm
21-196 25 mm

STILLE
21-192 - 196
Chisels
205 mm

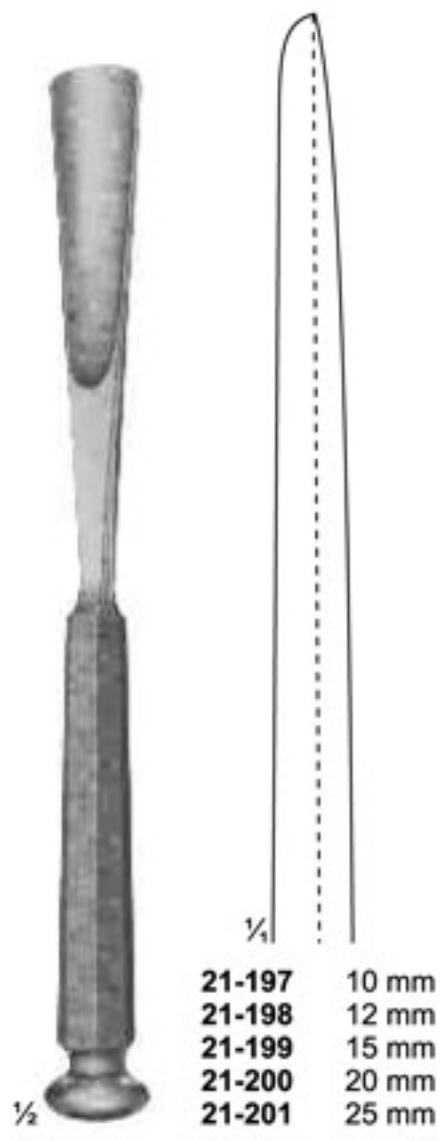

21-197 10 mm
21-198 12 mm
21-199 15 mm
21-200 20 mm
21-201 25 mm

STILLE
21-197 - 201
Gouges
205 mm

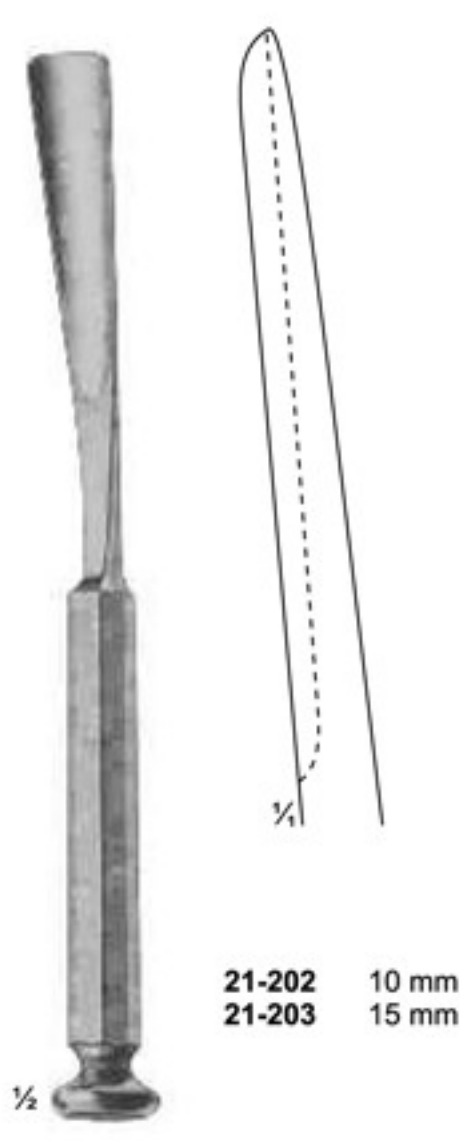

21-202 10 mm
21-203 15 mm

WALTER
21-202 - 203
Osteotomes
gouges for taking
grafts from the rib
205 mm

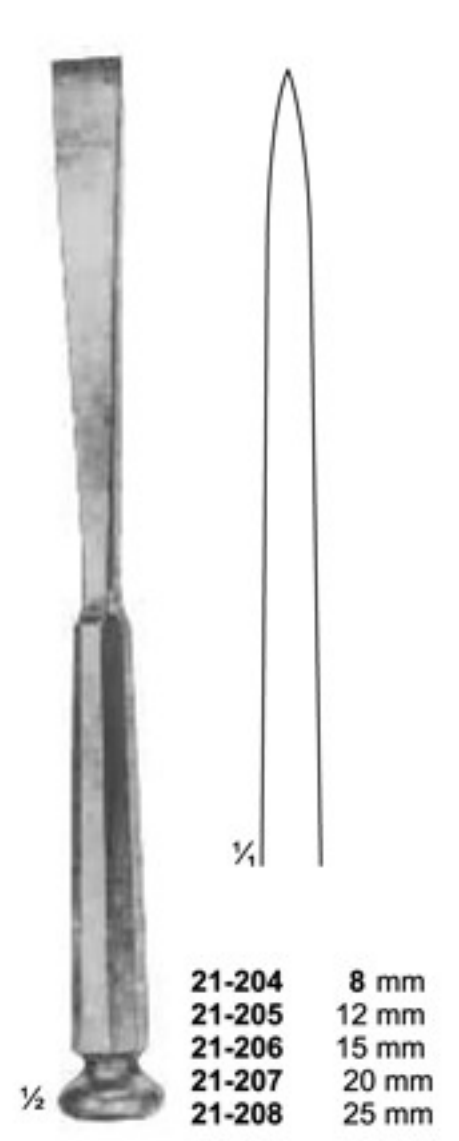

21-204 8 mm
21-205 12 mm
21-206 15 mm
21-207 20 mm
21-208 25 mm

STILLE
21-204 - 208
Osteotomes
205 mm

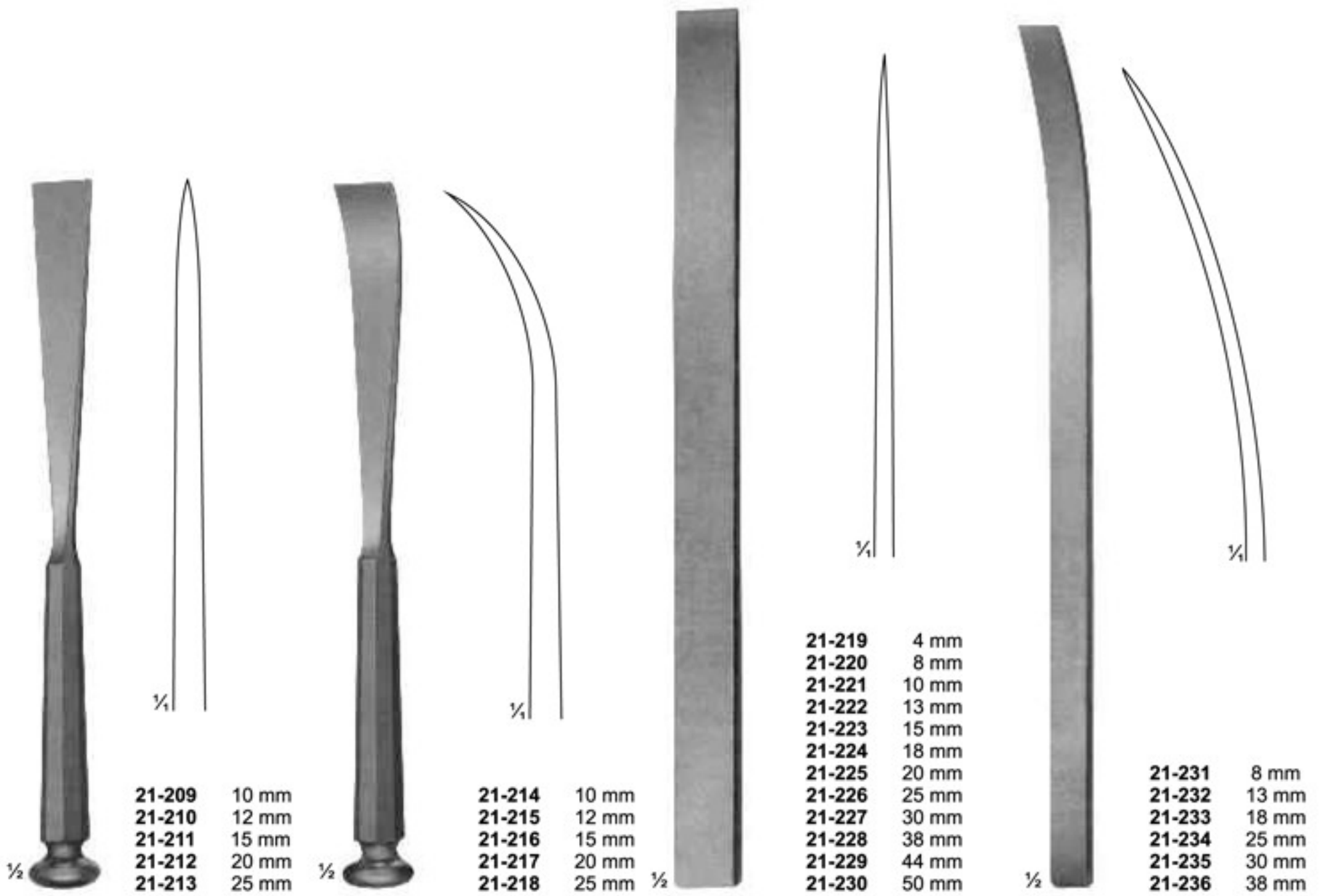

21-209 10 mm
 21-210 12 mm
 21-211 15 mm
 21-212 20 mm
 21-213 25 mm

21-214 10 mm
 21-215 12 mm
 21-216 15 mm
 21-217 20 mm
 21-218 25 mm

21-219 4 mm
 21-220 8 mm
 21-221 10 mm
 21-222 13 mm
 21-223 15 mm
 21-224 18 mm
 21-225 20 mm
 21-226 25 mm
 21-227 30 mm
 21-228 38 mm
 21-229 44 mm
 21-230 50 mm





21-231 8 mm
 21-232 13 mm
 21-233 18 mm
 21-234 25 mm
 21-235 30 mm
 21-236 38 mm

STILLE
 21-209 - 213
 Osteotomes
 205 mm

STILLE
 21-214 - 218
 Osteotomes, curved
 205 mm

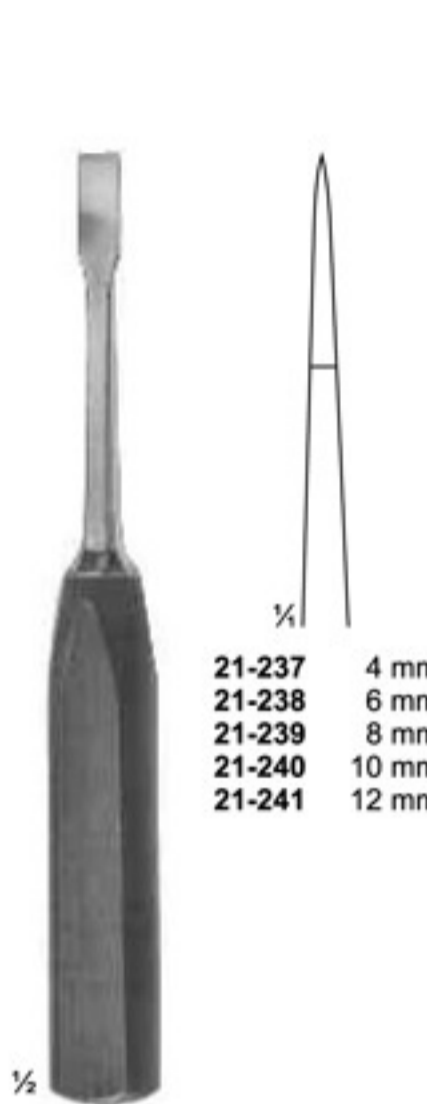
LAMBOTTE
 21-219 - 230
 Osteotomes
 245 mm

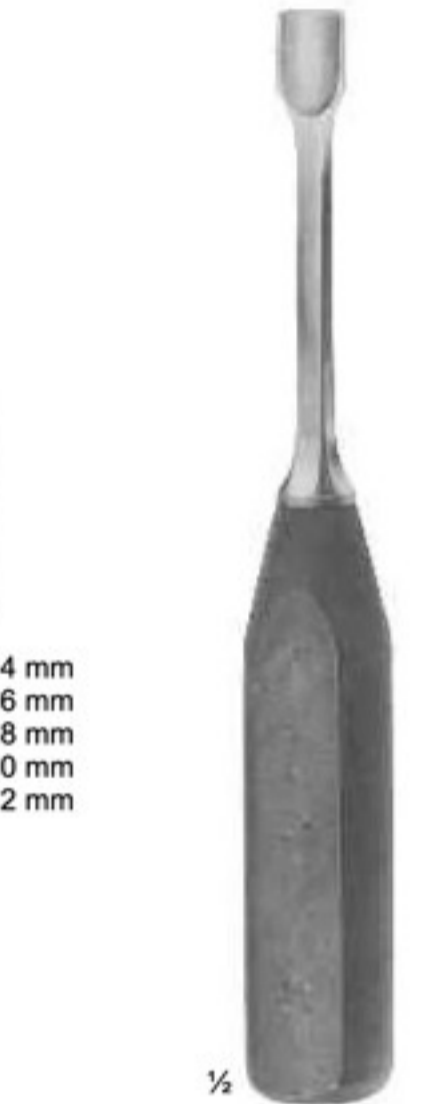
LAMBOTTE
 21-231 - 236
 Osteotomes, curved
 245 mm

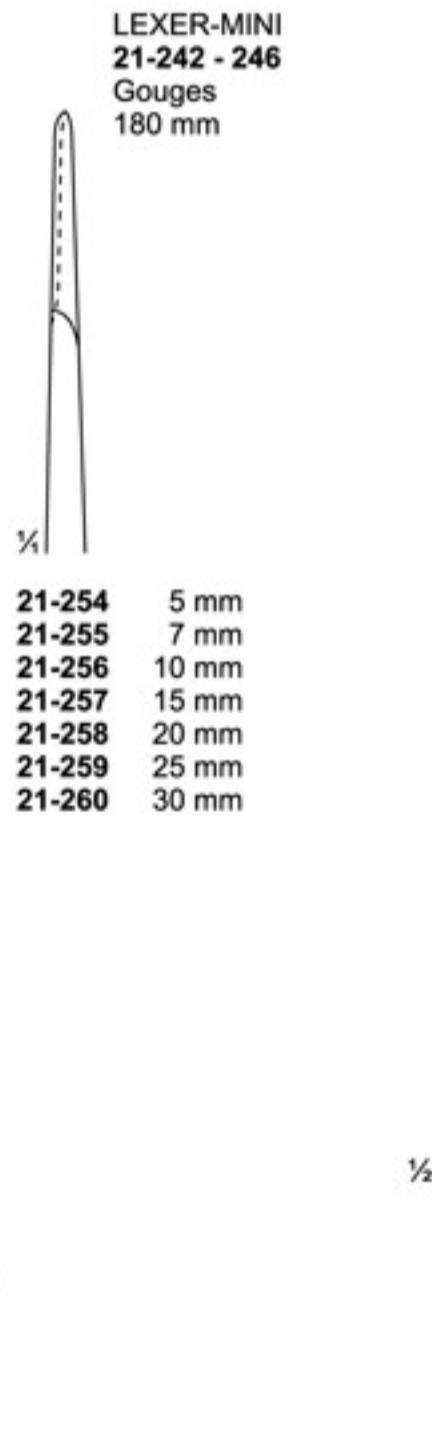
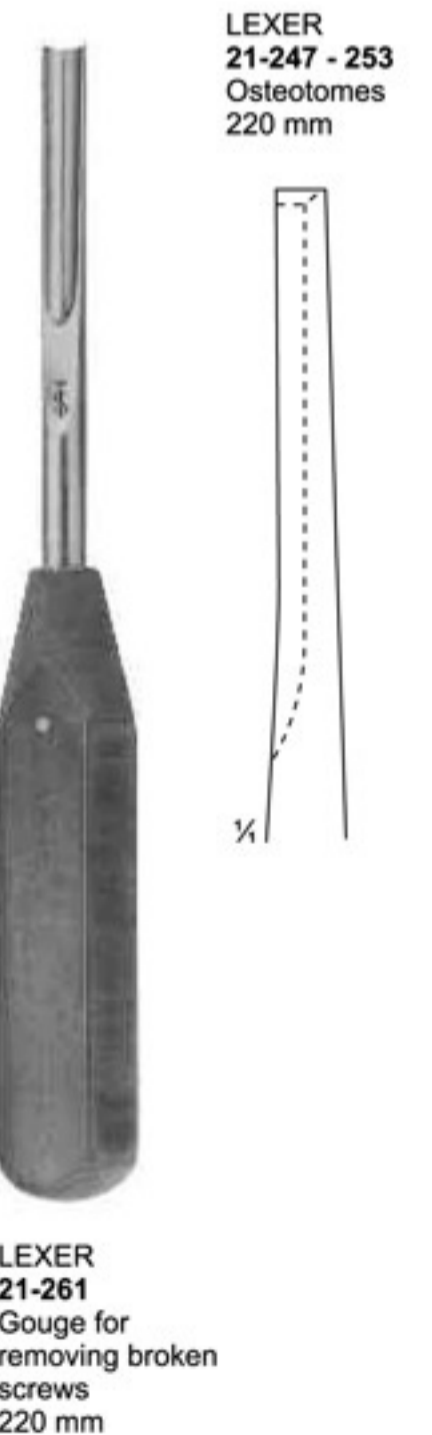
 <p>1/2</p> <p>21-237 4 mm 21-238 6 mm 21-239 8 mm 21-240 10 mm 21-241 12 mm</p>	 <p>1/2</p> <p>21-242 4 mm 21-243 6 mm 21-244 8 mm 21-245 10 mm 21-246 12 mm</p>	 <p>1/2</p> <p>21-247 5 mm 21-248 7 mm 21-249 10 mm 21-250 15 mm 21-251 20 mm 21-252 25 mm 21-253 30 mm</p>
<p>LEXER-MINI 21-237 - 241 Osteotomes 180 mm</p>  <p>1/2</p> <p>21-254 5 mm 21-255 7 mm 21-256 10 mm 21-257 15 mm 21-258 20 mm 21-259 25 mm 21-260 30 mm</p> <p>LEXER 21-254 - 260 Gouges 220 mm</p>	<p>LEXER-MINI 21-242 - 246 Gouges 180 mm</p>  <p>1/2</p> <p>LEXER 21-261 Gouge for removing broken screws 220 mm</p>	<p>LEXER 21-247 - 253 Osteotomes 220 mm</p>  <p>1/2</p> <p>21-262 5,5 mm 21-263 9,0 mm</p> <p>ZIELKE 21-262 - 263 Gouge for scoliose-operations 230 mm</p>

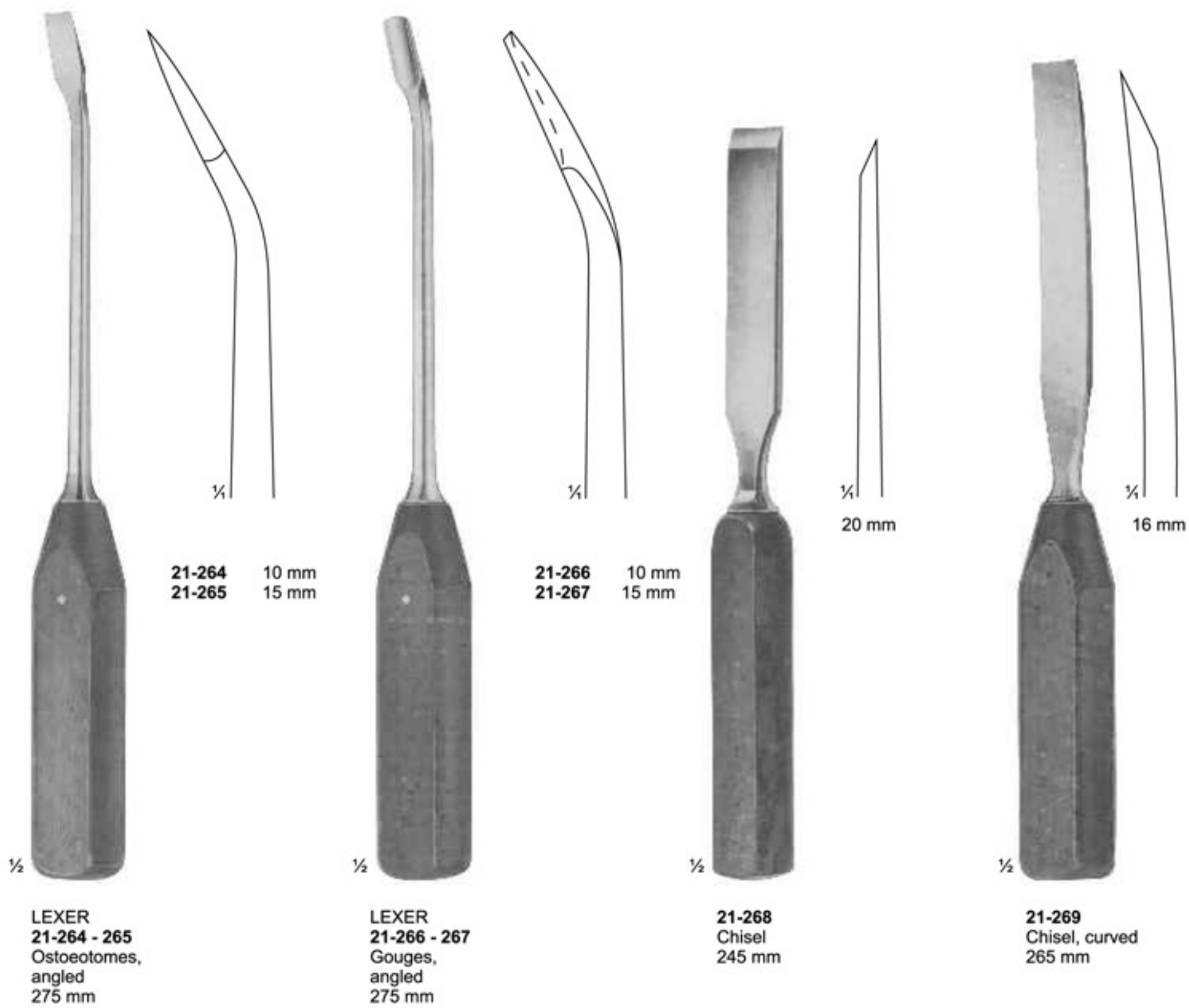

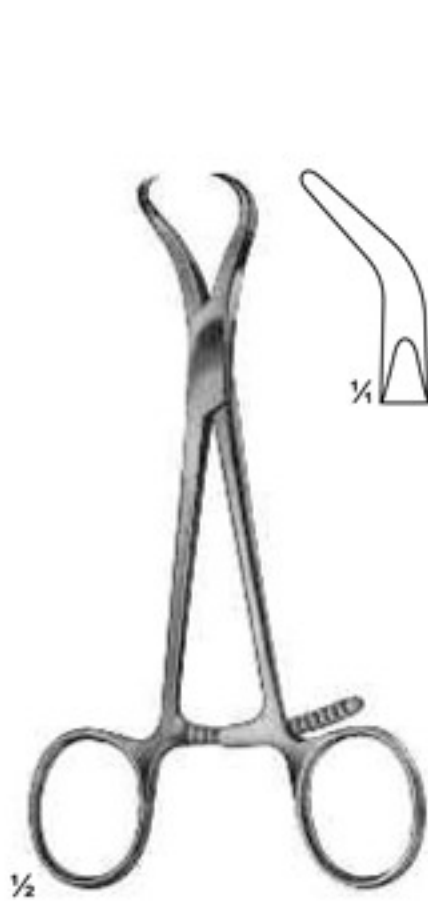

22-101
Reposition forceps,
for small fragments
135 mm



HAASE
22-102
Reposition forceps,
for mandibular
fractures
165 mm

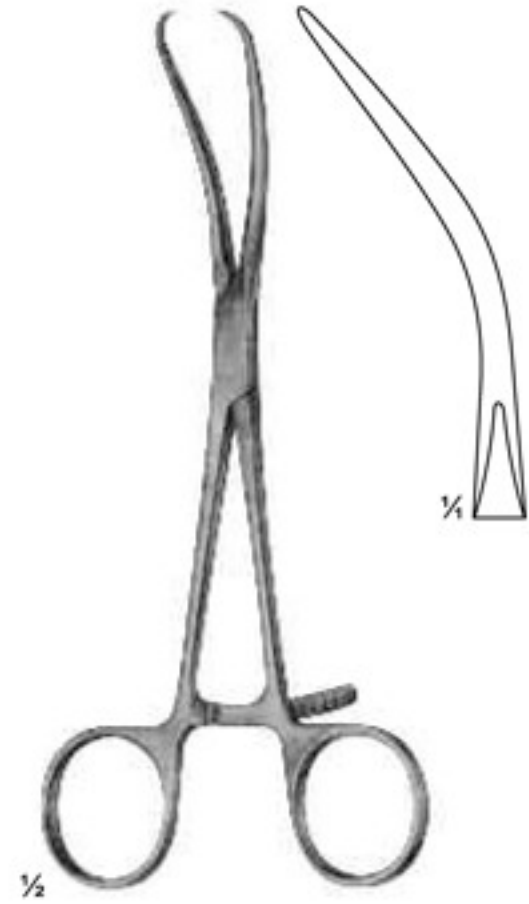

REILL
22-103
Reposition forceps,
170 mm



22-104
Reposition forceps
205 mm

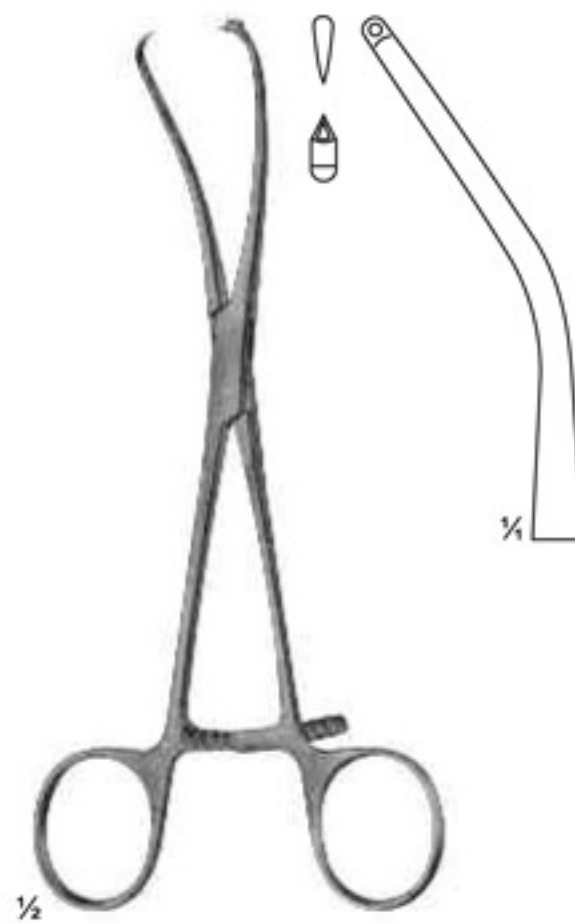

MEYER
22-105
Reposition forceps
for fingers, with drill
guide for KIRSCHNER
wires up to daim.1.0 mm
170 mm



22-106
Patella forceps
185 mm



22-107
Forceps with
ratchet fixation
140 mm



22-108
Forceps with
thread fixation
170 mm



22-109
Forceps with
thread fixation
235 mm

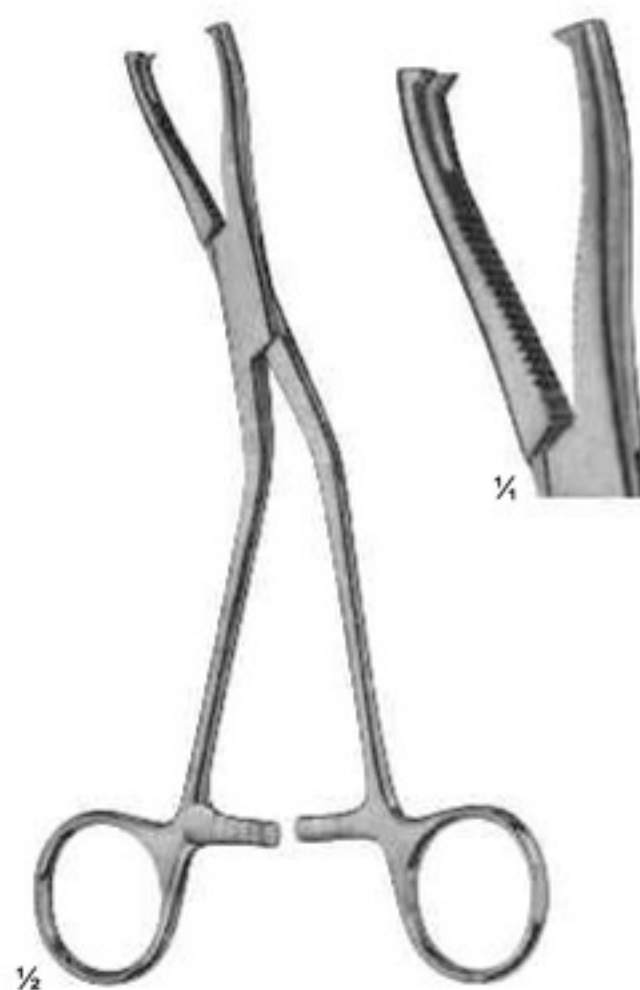

22-110
DINGMANN
185 mm



22-111
Sequestrum
forceps
200 mm



22-112
VAN BUREN
Sequestrum
forceps
225 mm



22-113
LANGENBECK
Sequestrum
forceps
205 mm



22-114
FERGUSSON
205 mm

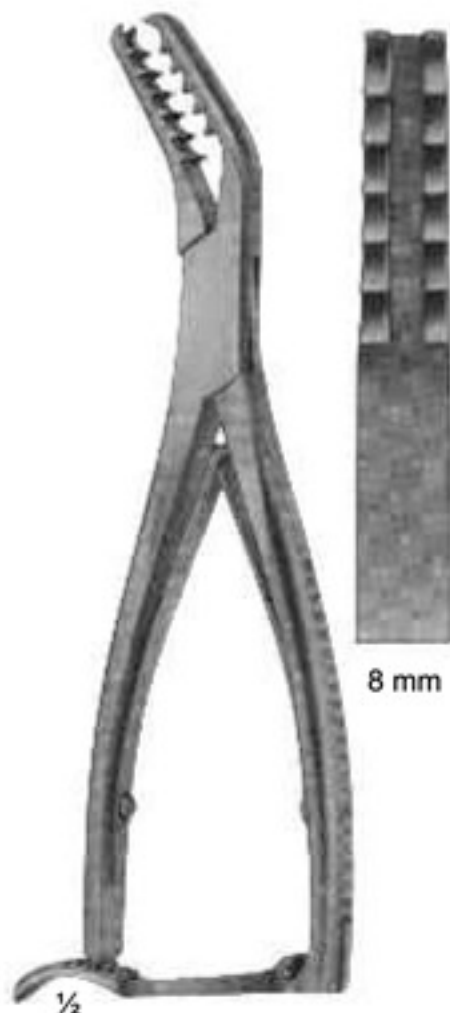
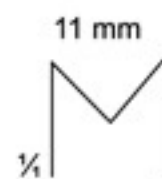
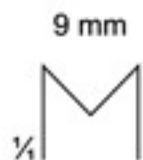
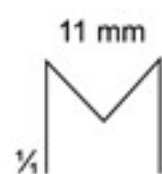
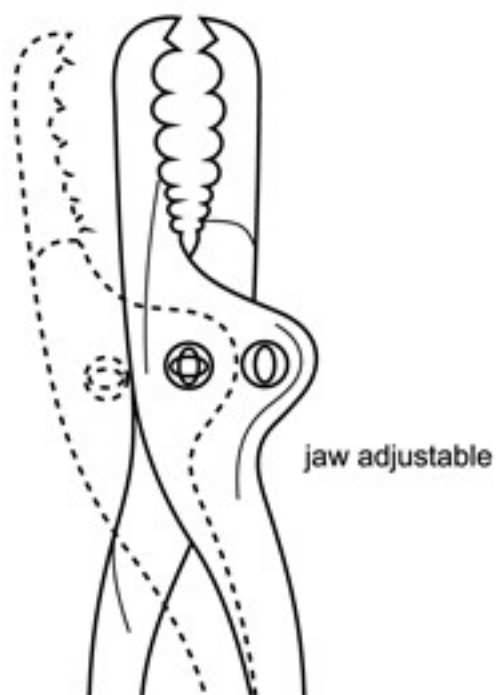

22-115
SEMB
190 mm



22-116
FARABEU F
230 mm



22-117
FARABEU F
255 mm



22-118
FARABEU-LAMBOTTE
255 mm

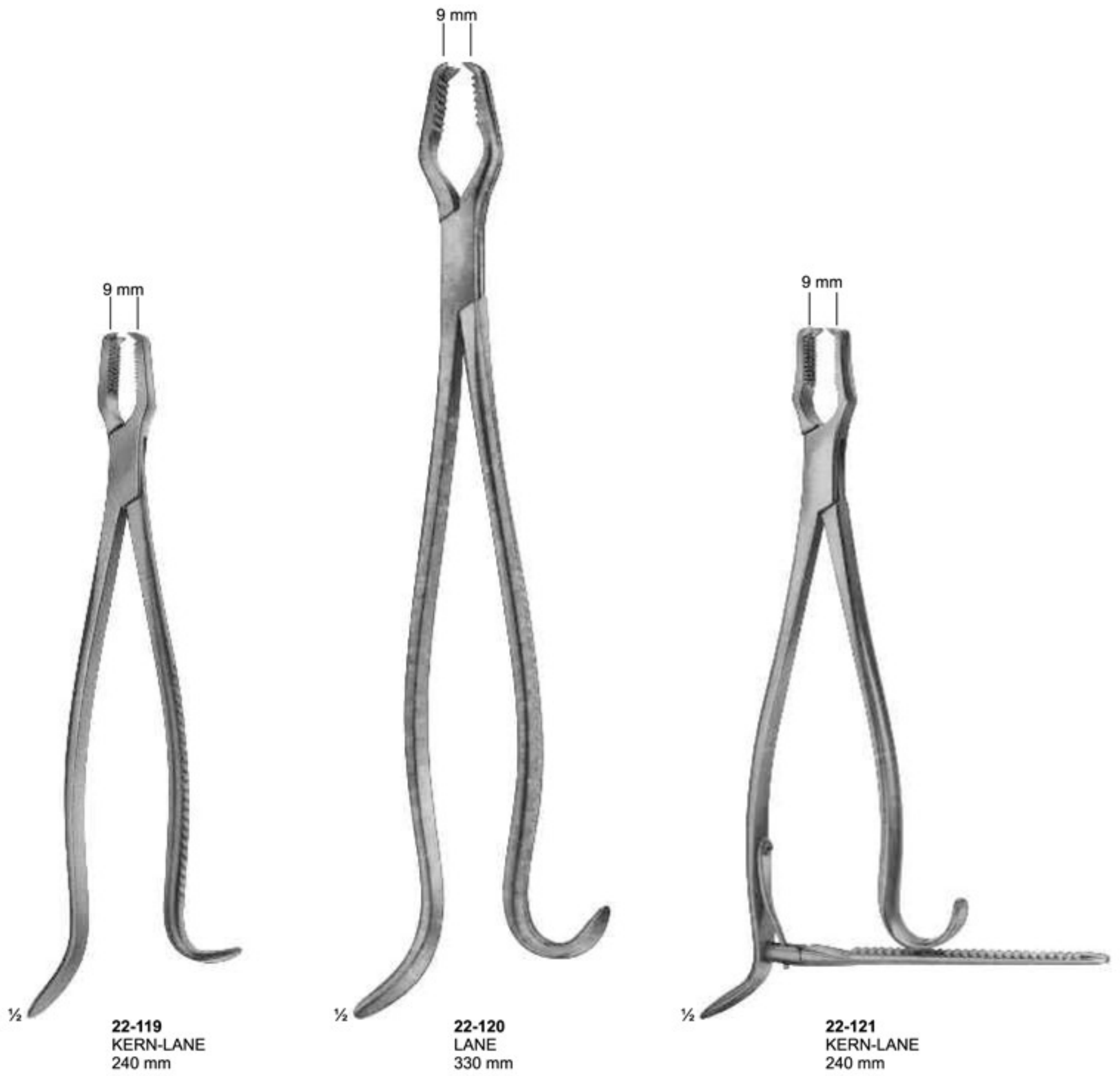

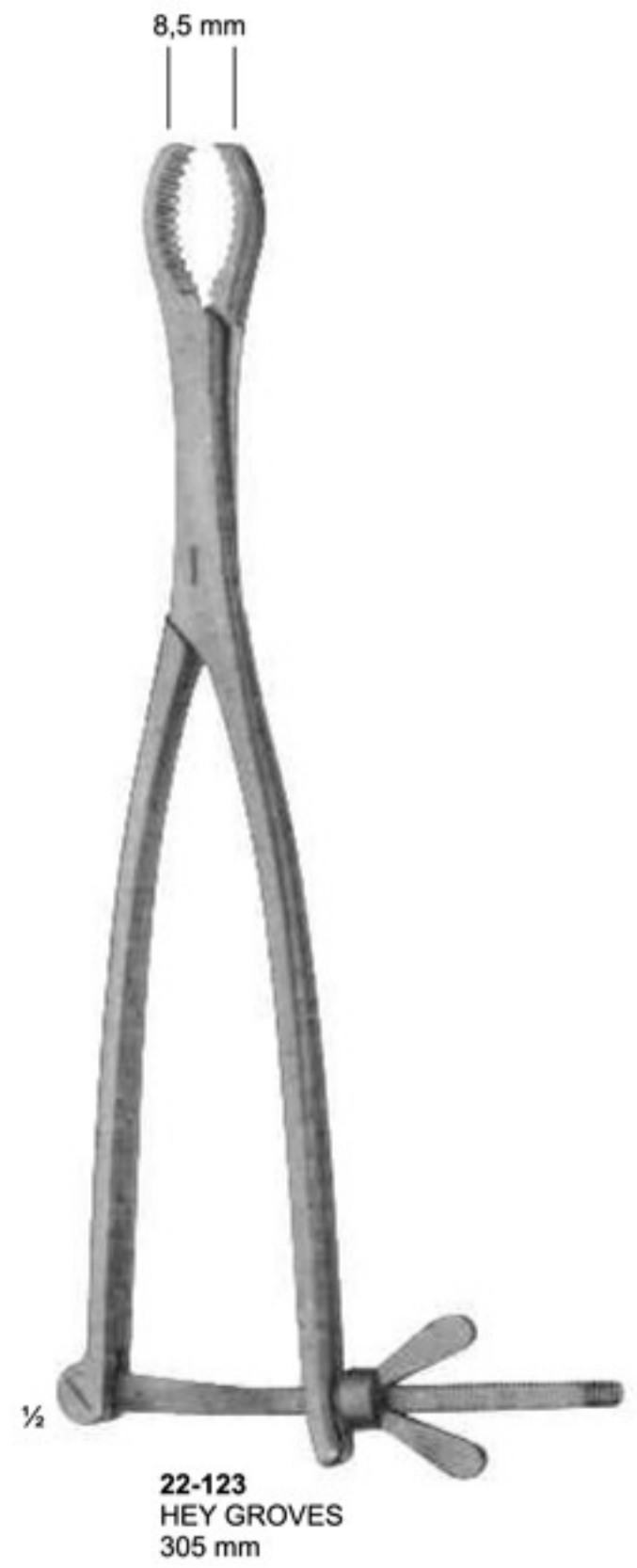

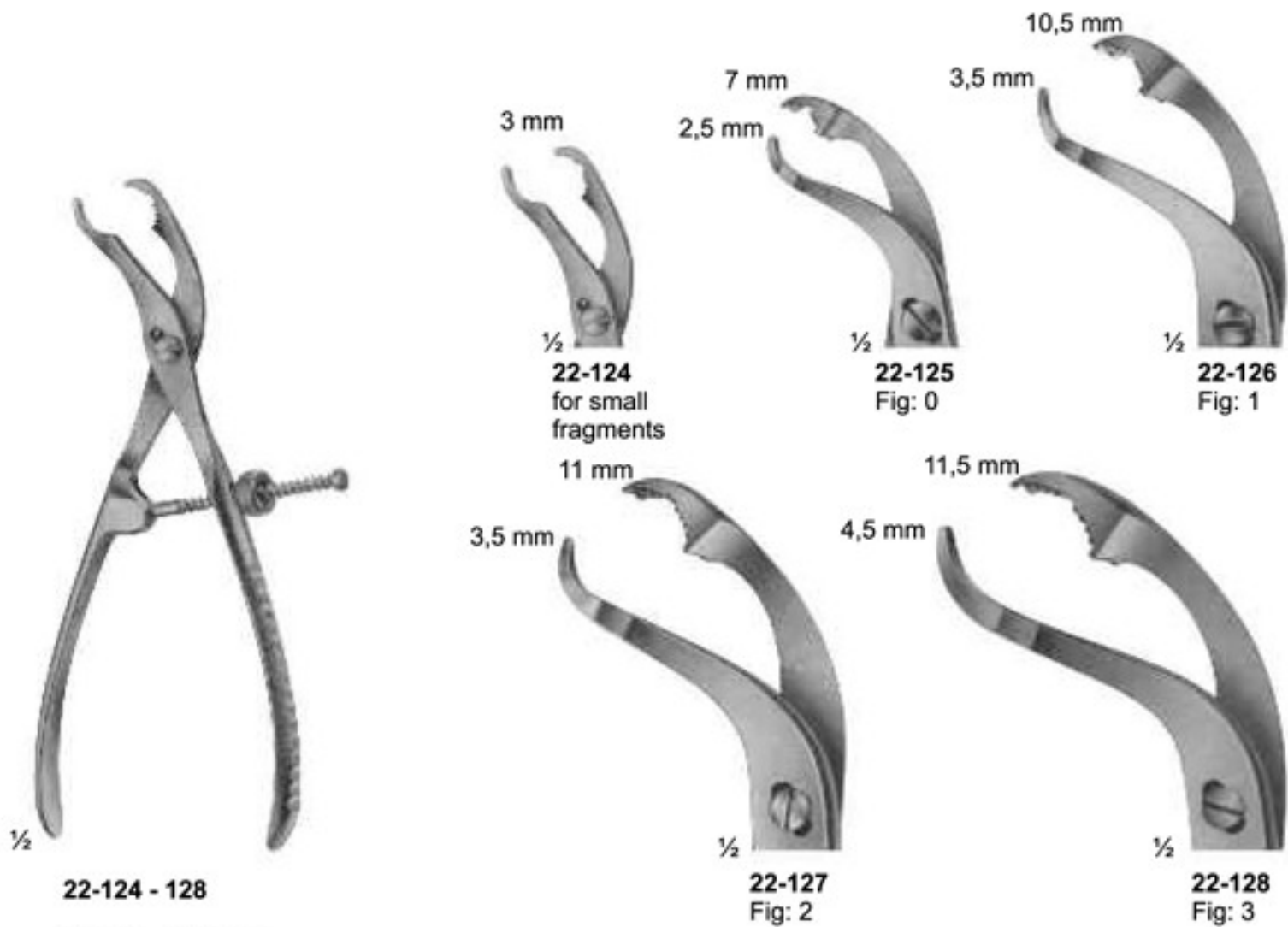

Self-centering forceps with thread fixation

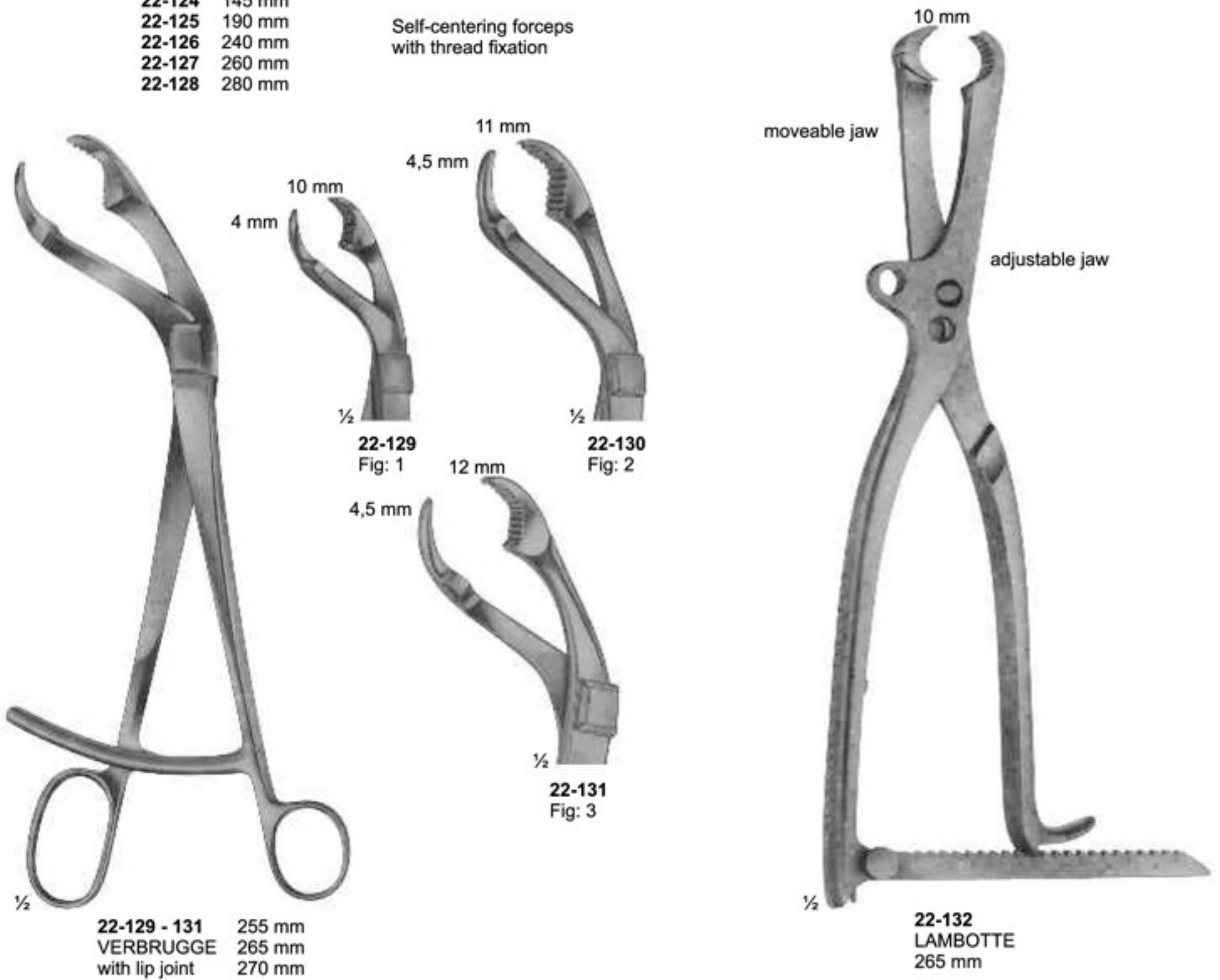



22-133 - 134
LOWMAN
22-133 170 mm
22-134 205 mm



22-135
LOWMAN-GERSTER
210 mm



22-136
LOWMAN-HOGLUND
175 mm



22-137 - 138
Synovectomy rongeur
width of jaws 1.2 mm
130 mm



22-139 - 140
Synovectomy rongeur
width of jaws 2.0 mm
130 mm



22-141
STELLBRINK
Synovectomy rongeur
175 mm



22-142
STELLBRINK
Synovectomy rongeur
170 mm



22-143
LURE-FRIEDMANN
145 mm

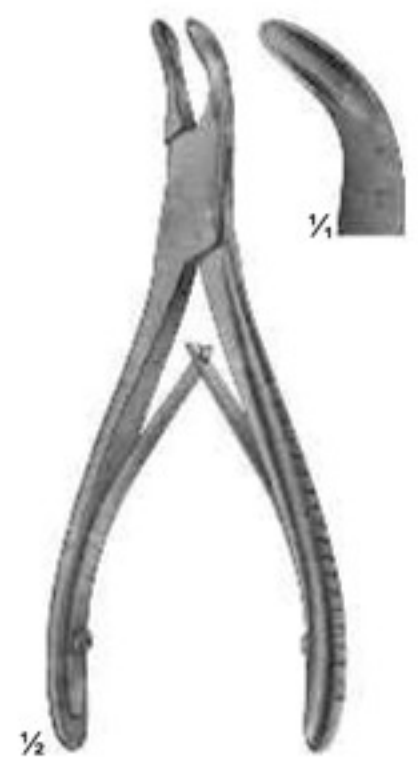

22-144
140 mm



22-145
LURE
150 mm



22-146
LURE
155 mm

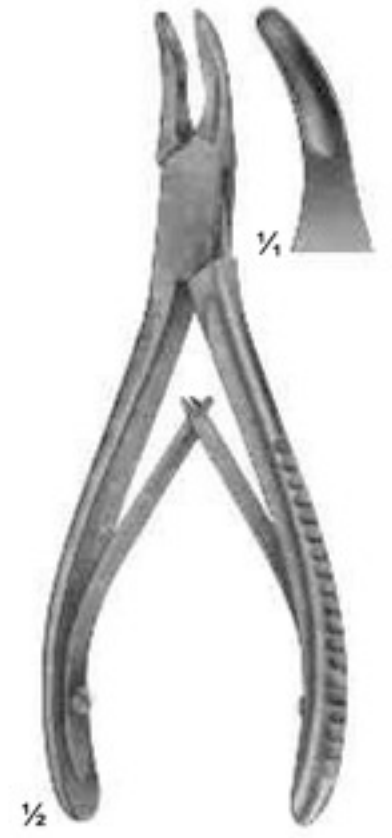

22-147
BLUMENTHAL
155 mm



22-148
BLUMENTHAL
150 mm

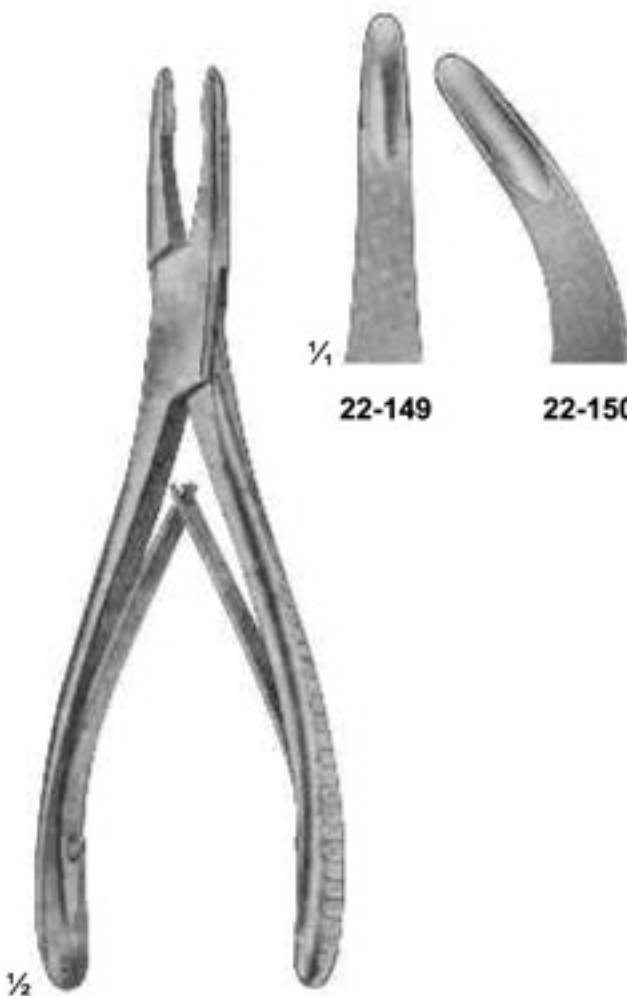

22-149 - 150
JANSEN
175 mm

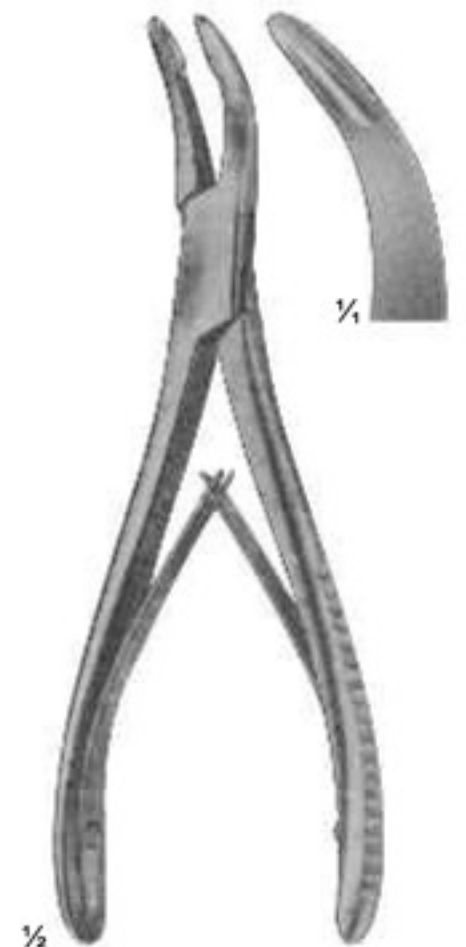

22-151
BANE-HARTMANN
175 mm



22-152
ALEXANDER
140 mm

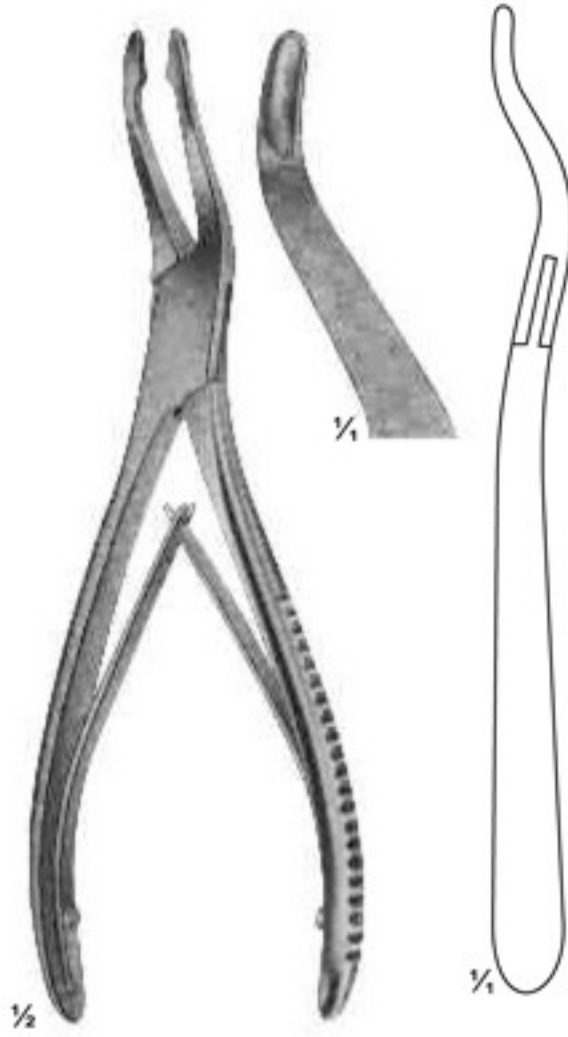

22-153
JANSEN
190 mm

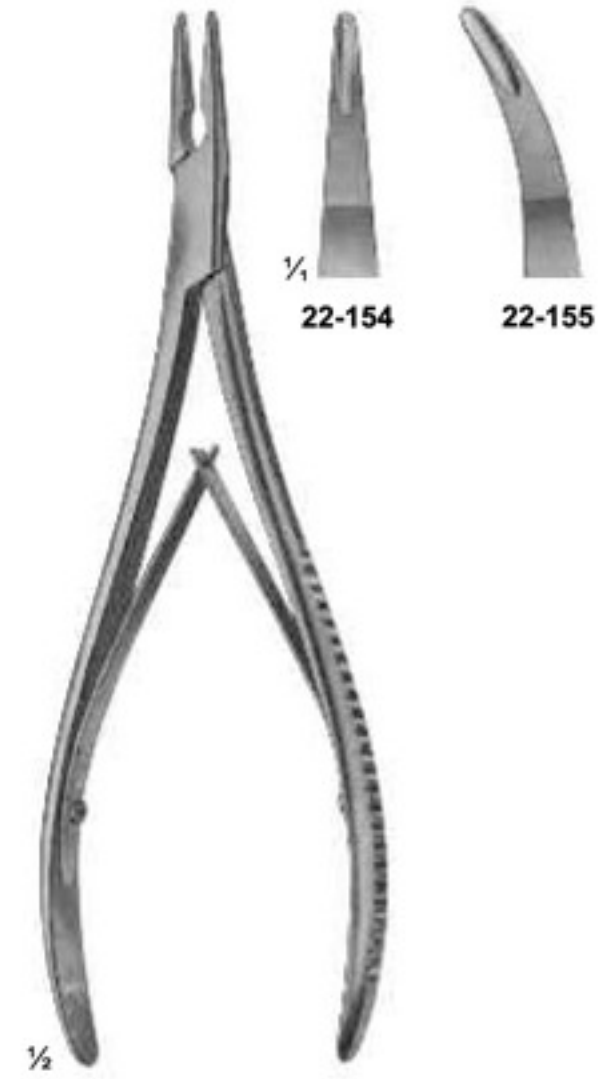

22-154 - 155
LEMPERT
200 mm

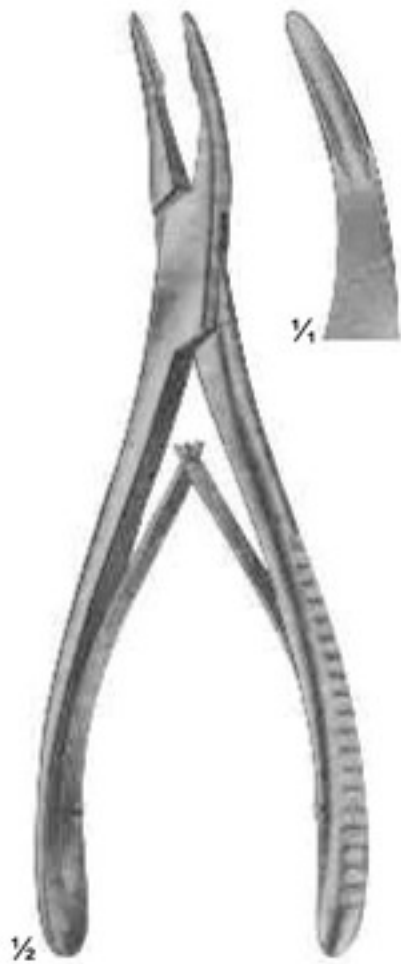

22-156
BEYER
180 mm

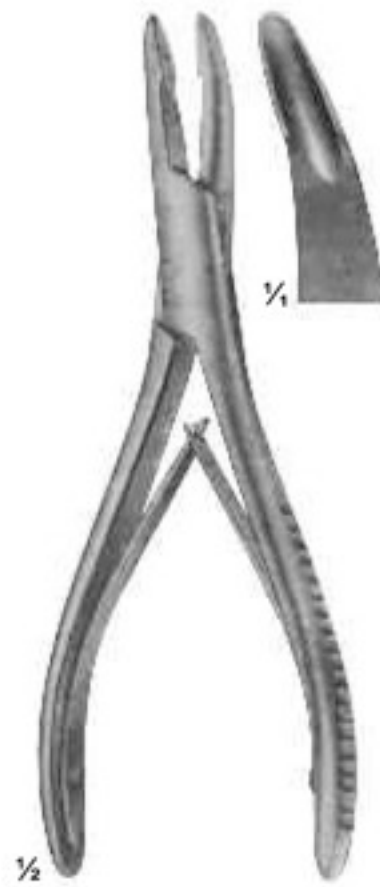

22-157
MEAD
165 mm

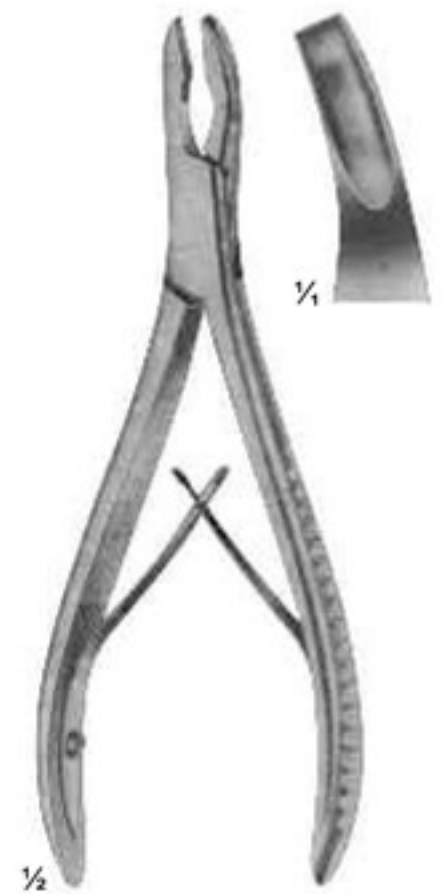

22-158
MEAD
165 mm

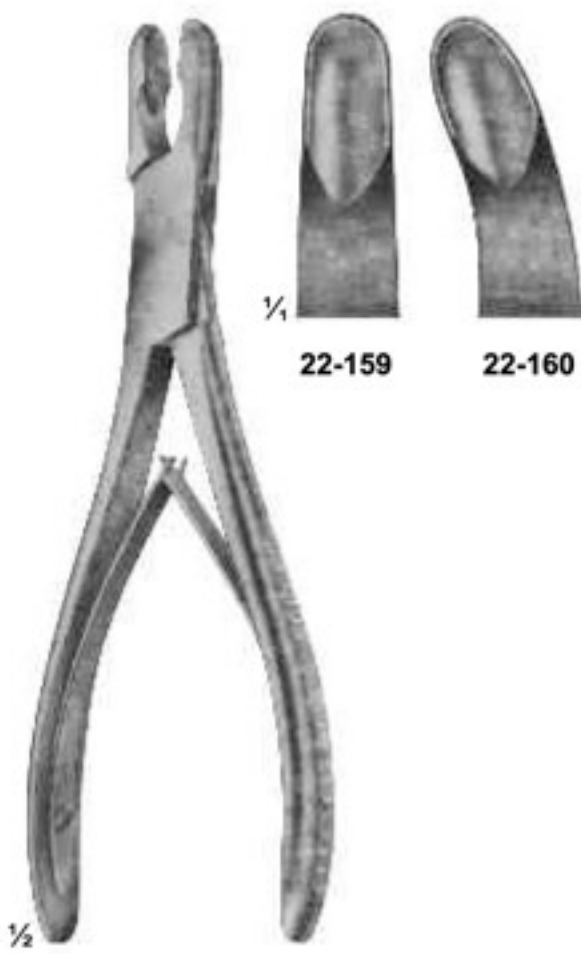

22-159 22-160

22-159 - 160
LURE
175 mm



22-161
LURE
180 mm

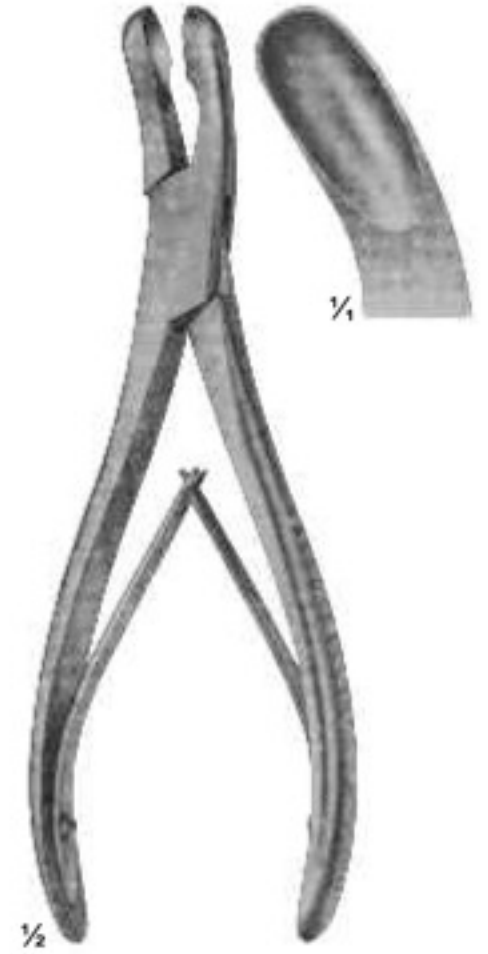

22-162
LURE
180 mm

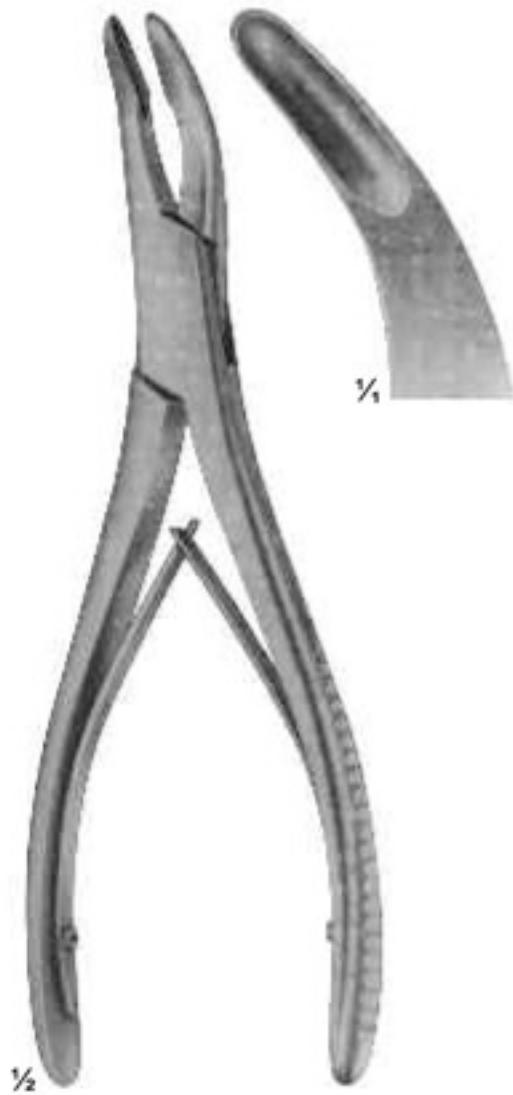

22-163
OLIVECRONA
205 mm



22-164 - 165
BOHLER
155 mm

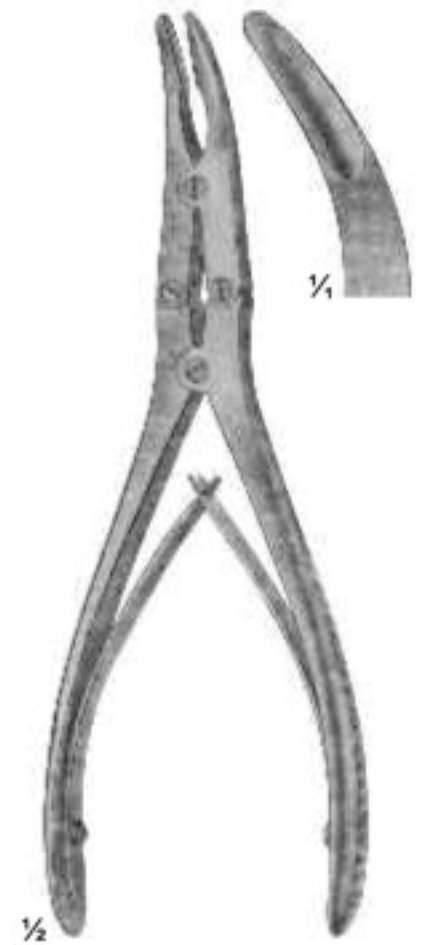

22-166
MARQUARDT
200 mm

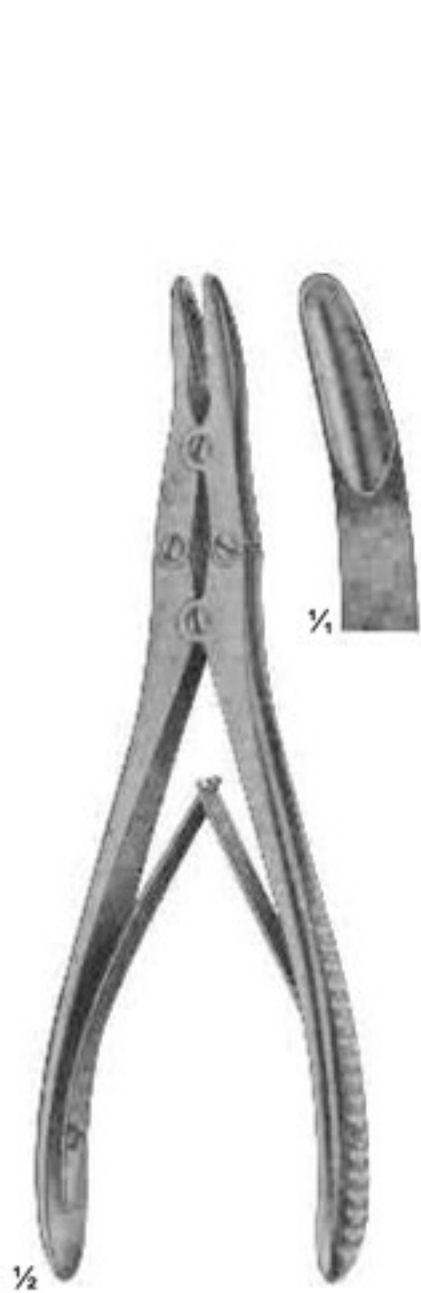

22-167
RUSKIN
190 mm



22-168
ROTTGEN-RUSKIN
240 mm

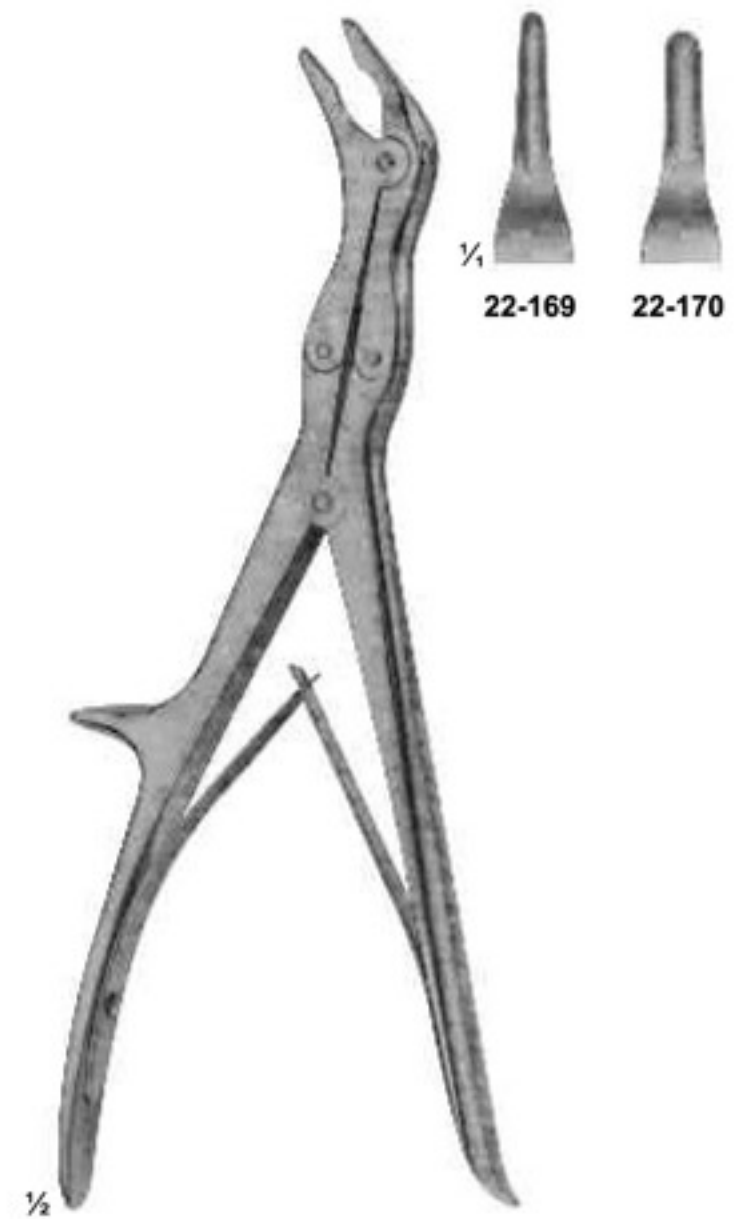

22-169 - 170
ECHLIN
230 mm



22-171
STILLE
235 mm



22-172
LEKSELL-STILLE
240mm



22-173
STILLE-RUSKIN
240mm



22-174
LURE-STILLE
225 mm



22-175
LURE-STILLE
225 mm



17-233 - 235
DE BAKEY
205 mm, 225 mm, 240 mm



$\frac{1}{4}$
17-233 41 mm
17-234 65 mm
17-235 80 mm



17-236 - 238
DE BAKEY
200 mm, 225 mm, 240 mm



$\frac{1}{4}$
17-236 41 mm
17-237 65 mm
17-238 80 mm

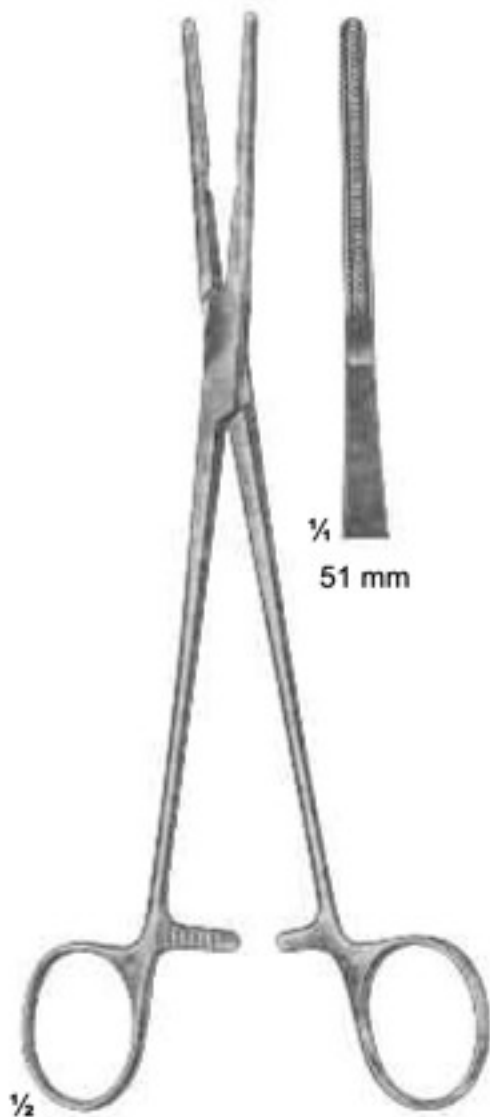

17-239
DE BAKEY
210 mm



$\frac{1}{4}$
51 mm



17-240
DE BAKEY
210 mm

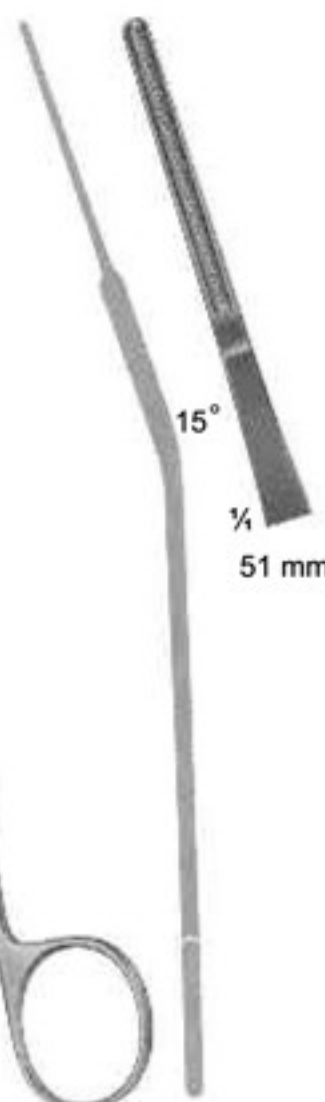

15°
 $\frac{1}{4}$
51 mm



17-241
DE BAKEY
160 mm



$\frac{1}{4}$
56 mm

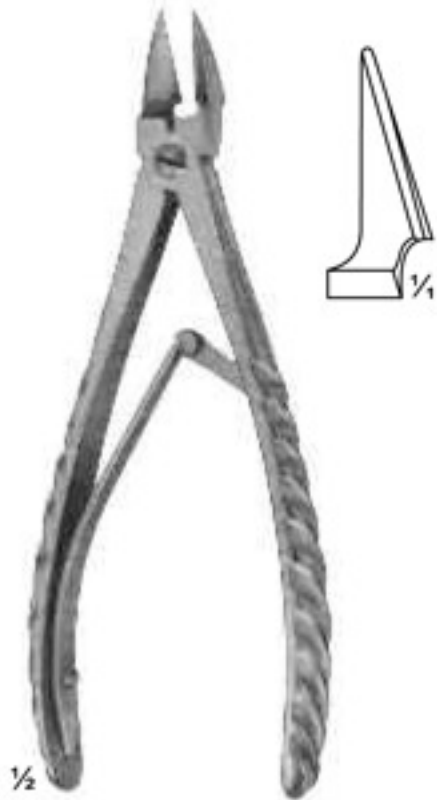

22-178
STAMM
150 mm

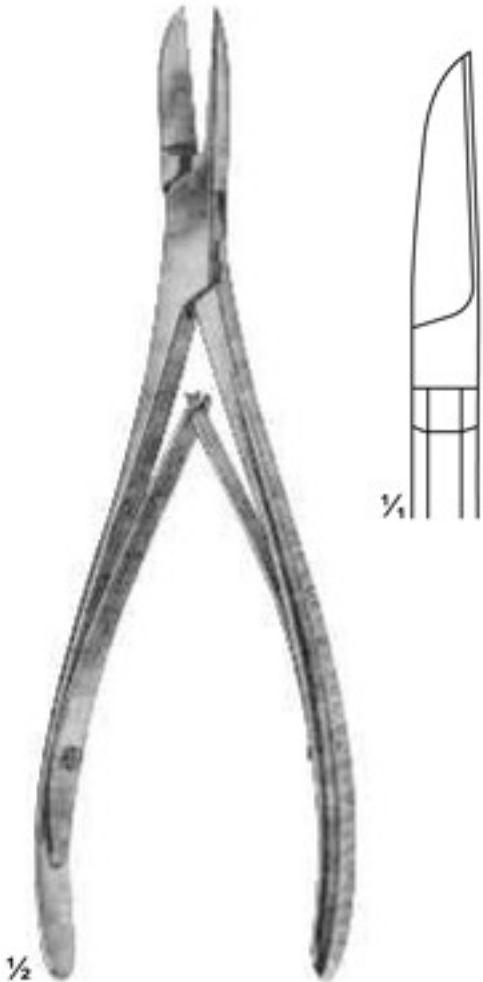

22-179
KAZANJIAN
185 mm

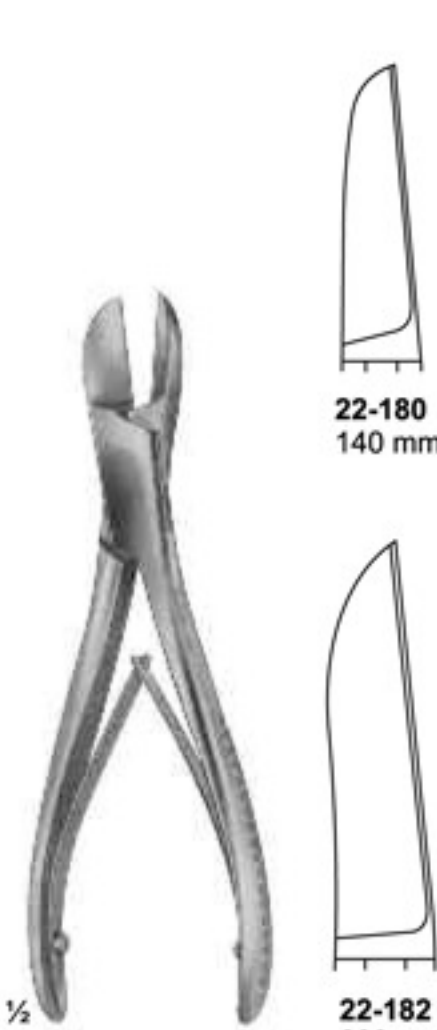

22-180 - 183
LISTON



22-180
140 mm



22-181
170 mm



22-182
200 mm



22-183
220 mm



22-184 - 186
LISTON



22-184
170 mm



22-185
200 mm



22-186
220 mm

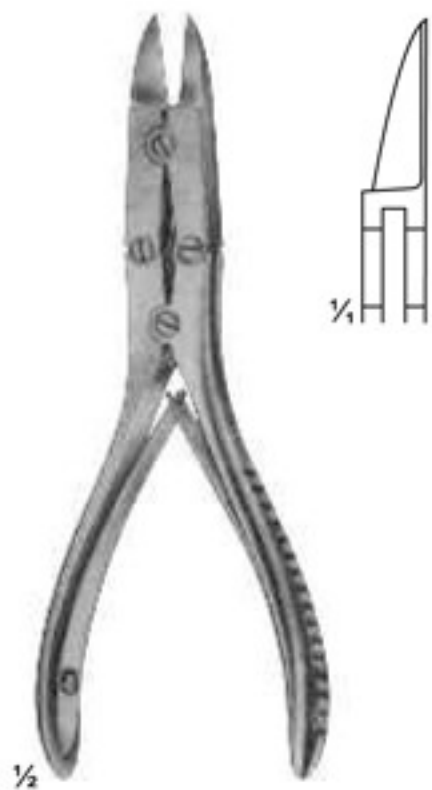

22-187
BOHLER
145 mm



22-188
RUSKIN-LISTON
190 mm

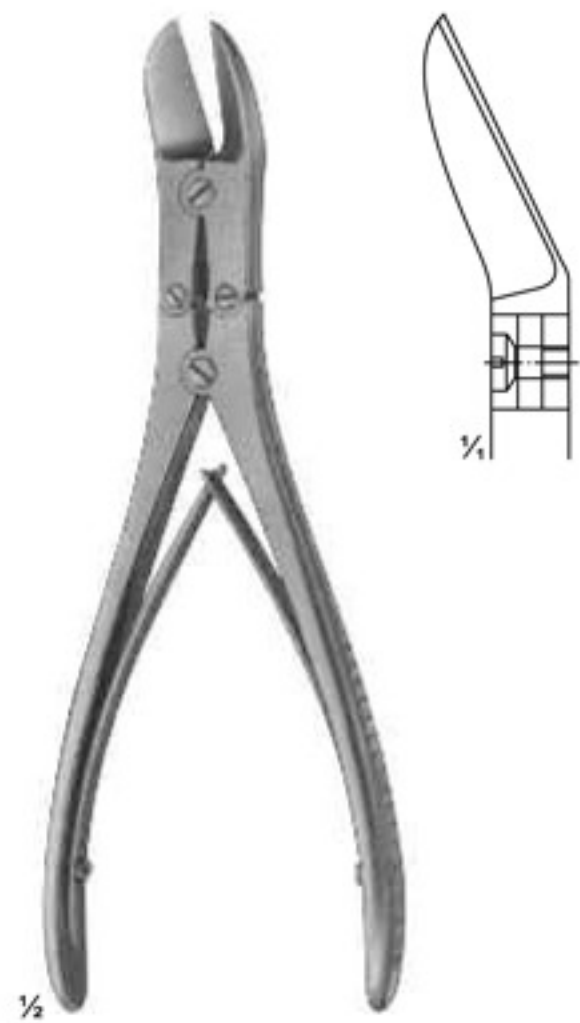

22-189
RUSKIN-LISTON
190 mm

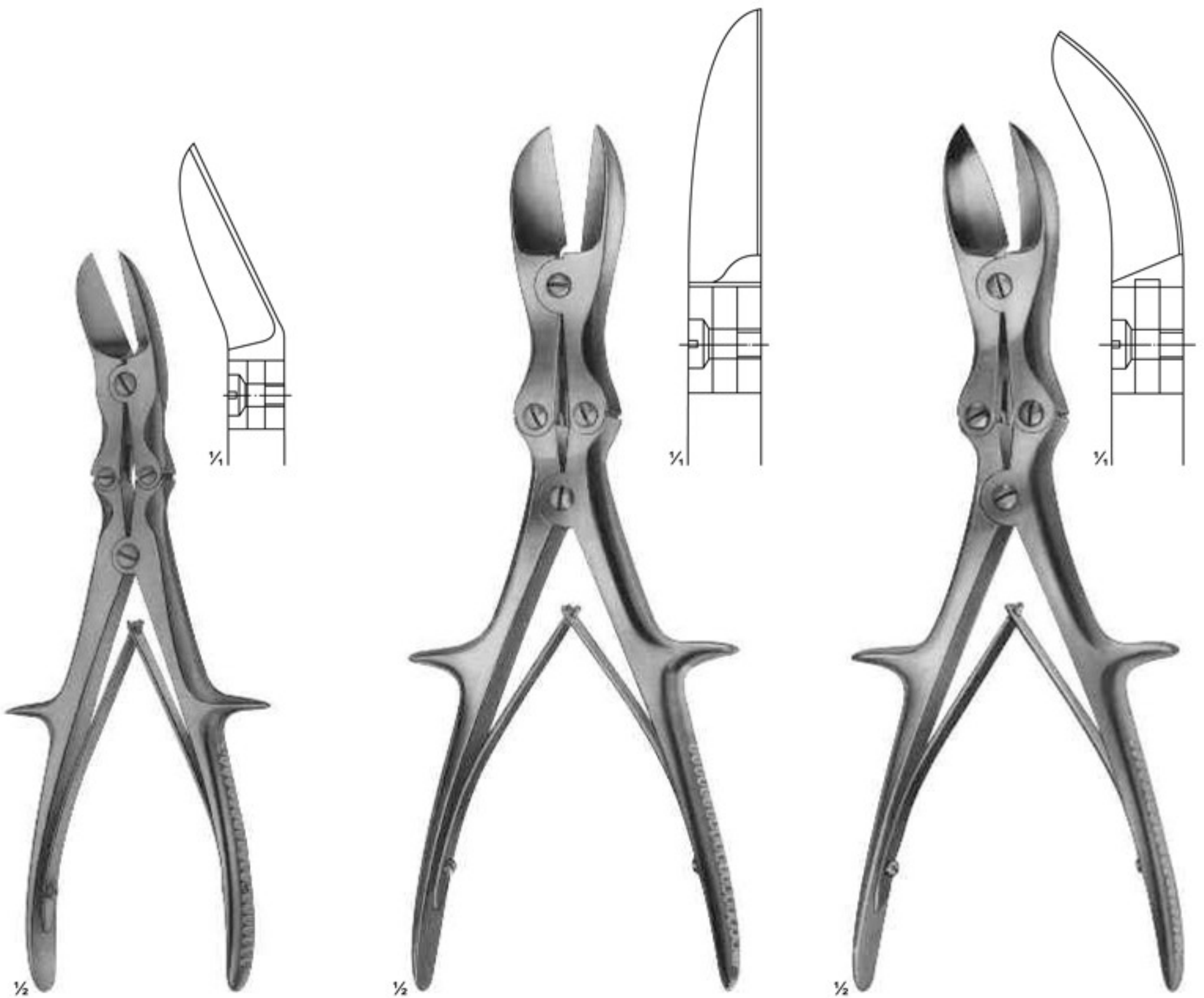

22-190
LISTON
curved on flat
240 mm

22-191
LISTON
straight
280 mm

22-192
LISTON
curved on flat
280 mm

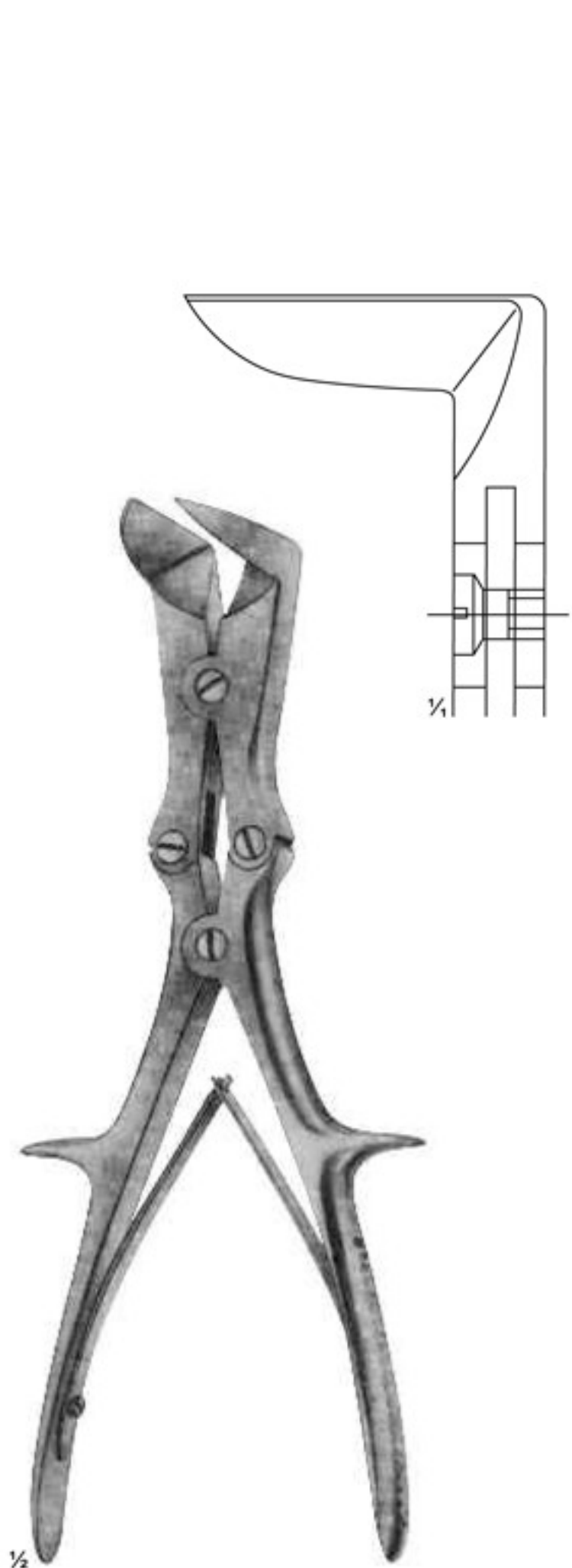

22-193
LISTON-STILLE
265 mm

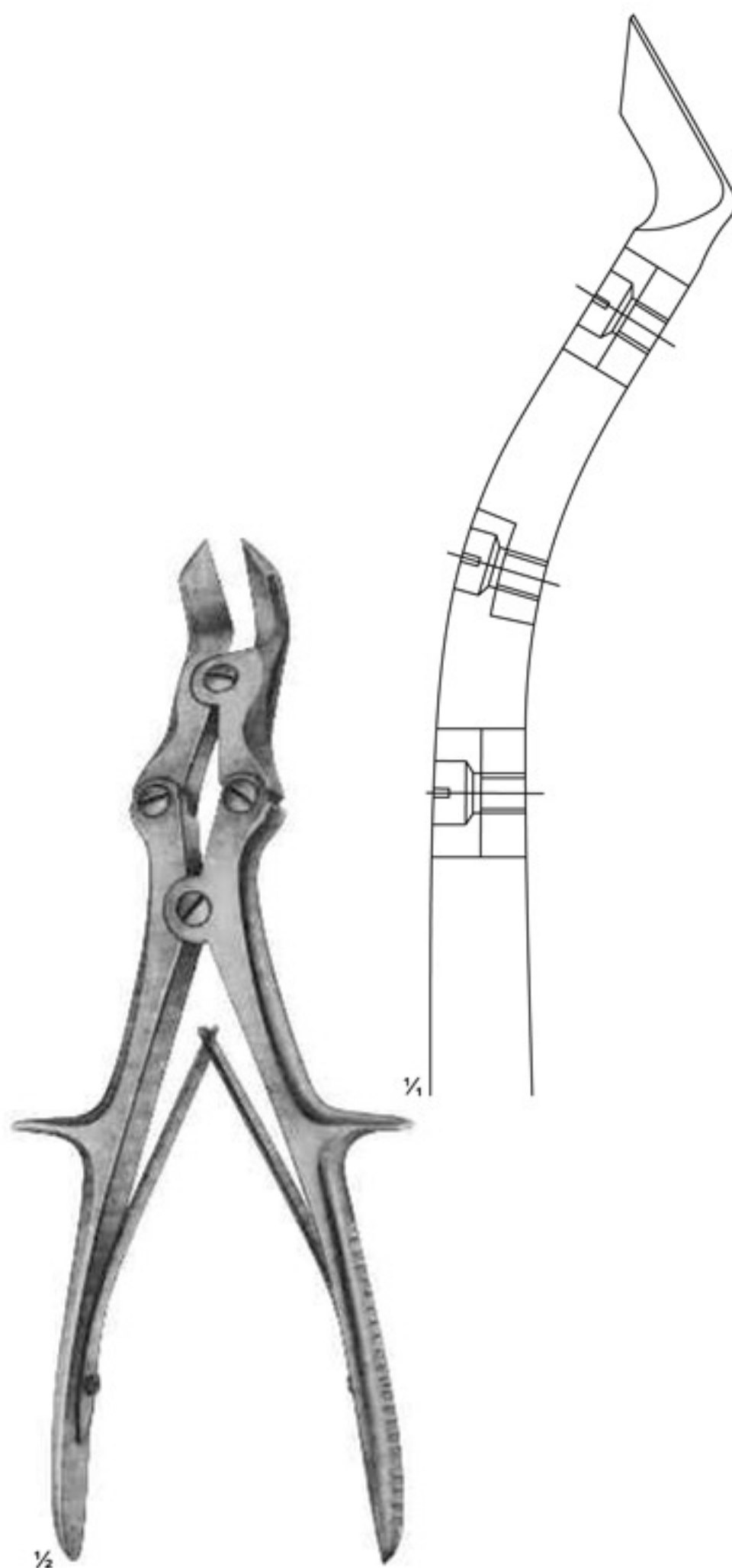

22-194
LISTON-KEY-HORSLEY
(TUDOR EDWARDS)
255 mm



22-195
BIRCHER
200 mm



22-196
BIRCHER
200 mm

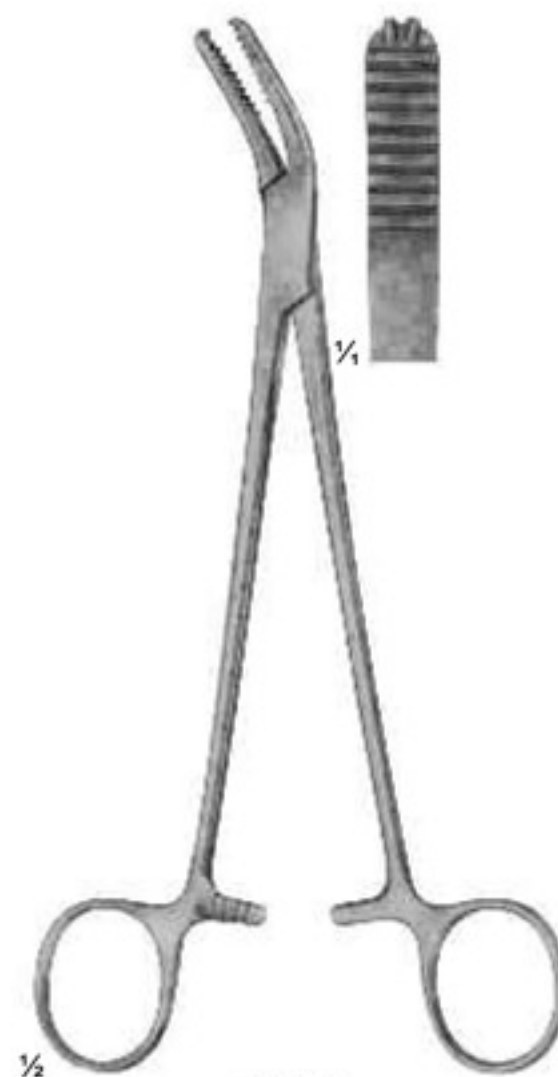

22-197
WELLER
200 mm

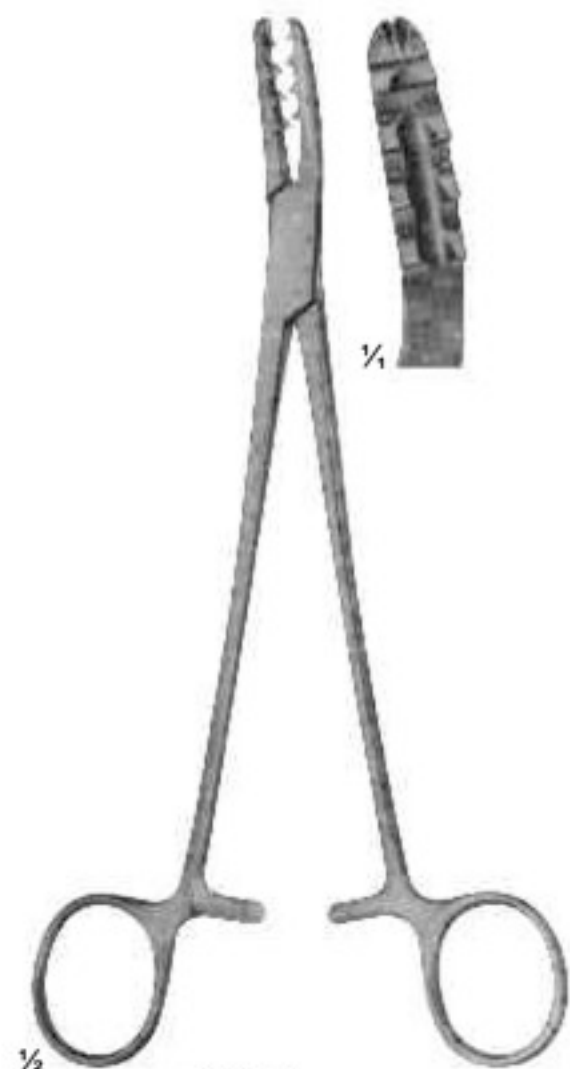

22-198
BIRCHER-GANSKE
200 mm



22-199
BIRCHER-GANSKE
200 mm



22-200
MARTIN
205 mm

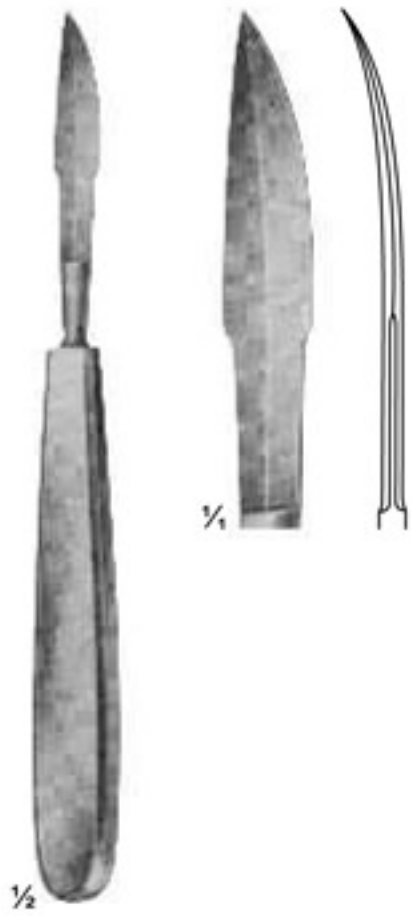

22-201
170 mm

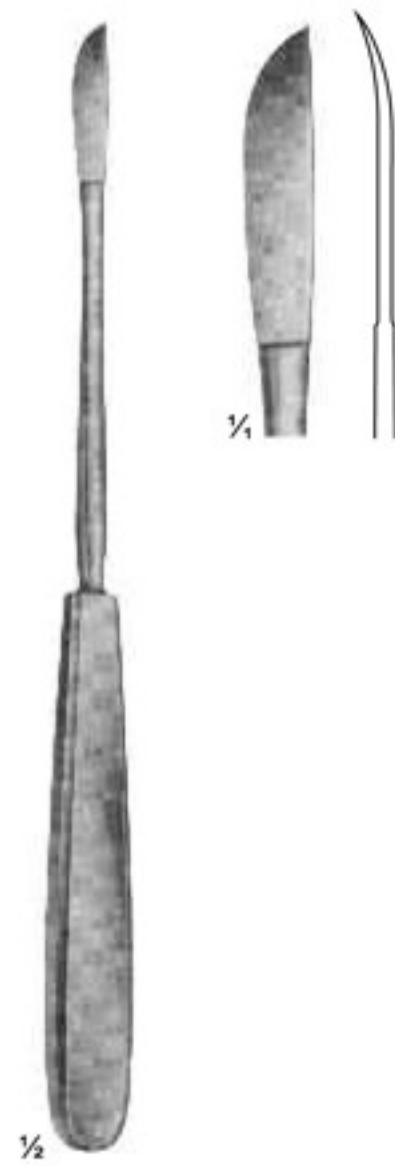

22-202
NEFF
215 mm



22-203
NEFF
215 mm

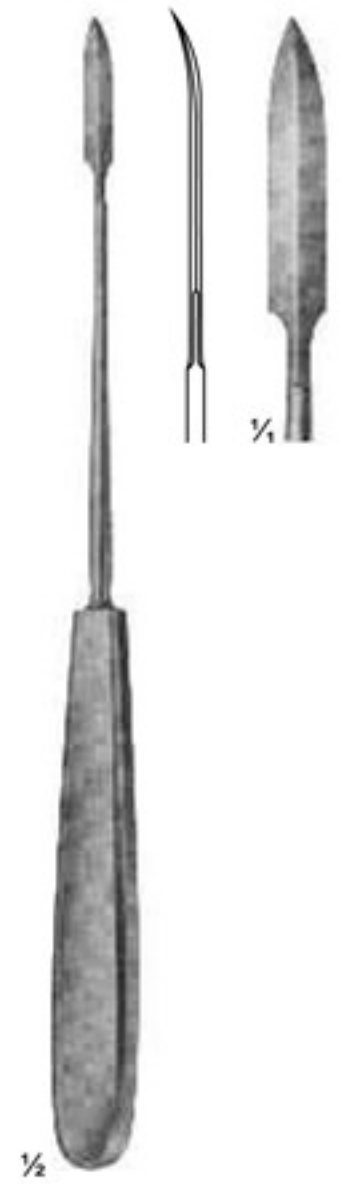

22-204
WAGNER
215 mm

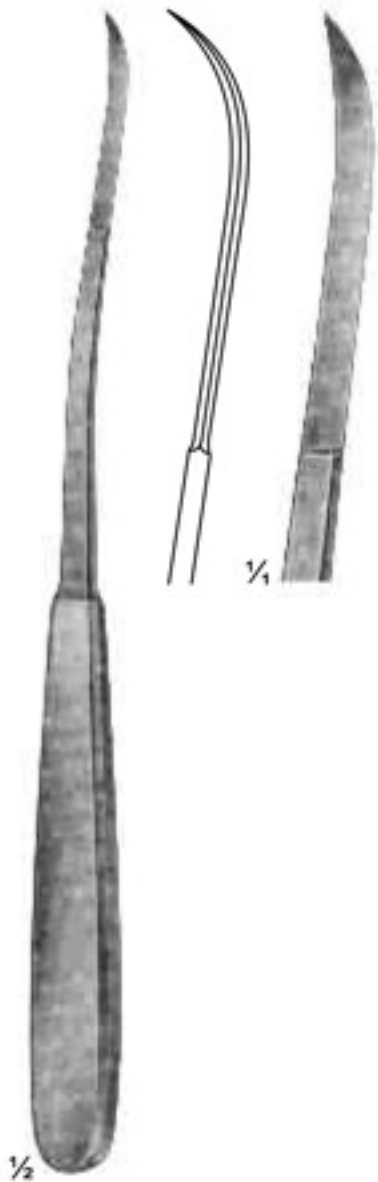

22-205
SALENIUS
220 mm



22-206
CHNAD. MODELL
200 mm

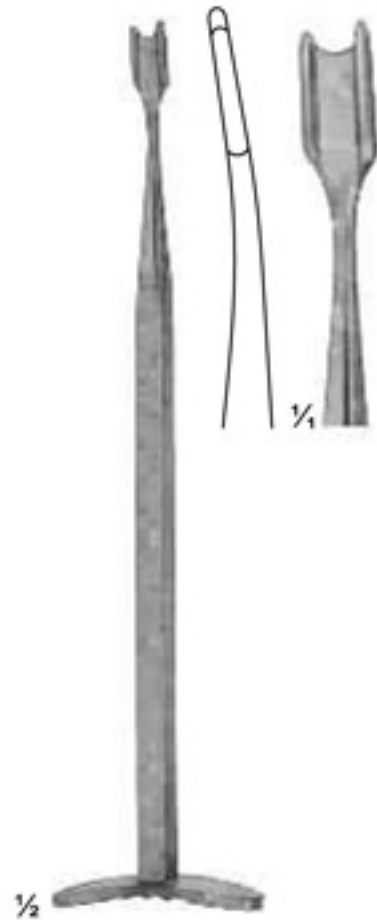

22-207
SMILLIE
170 mm

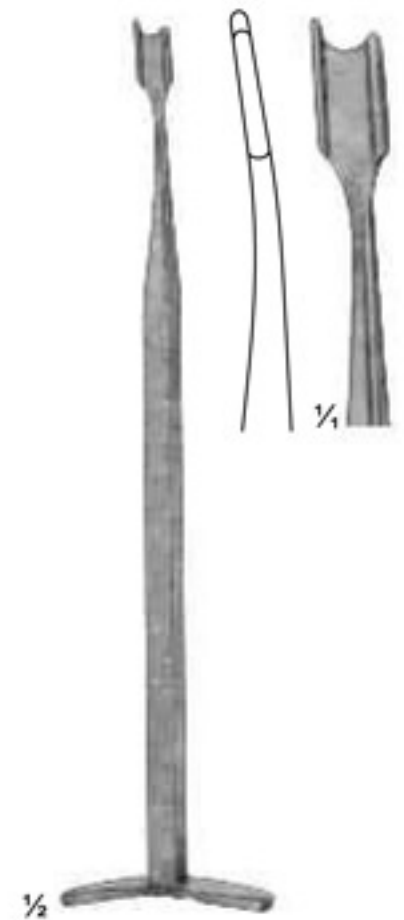

22-208
SMILLIE
170 mm

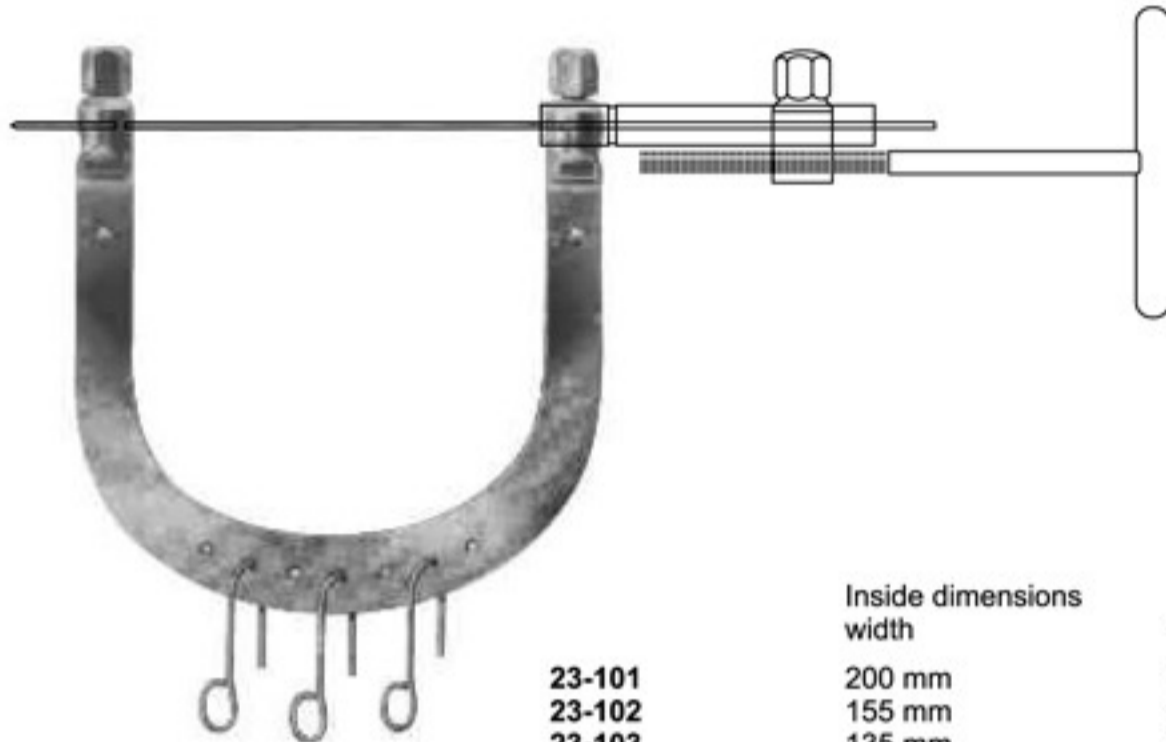

23-101 - 107
KIRSCHNER
Wire traction bows,
to be used with
KIRSCHNER-wires
up to 2.5 mm diam.,
With 3 hooks,
stainless steel

	Inside dimensions width	depth
23-101	200 mm	155 mm
23-102	155 mm	155 mm
23-103	135 mm	130 mm
23-104	120 mm	120 mm
23-105	105 mm	100 mm
23-106	95 mm	110 mm
23-107	95 mm	70 mm



23-108
Wrench, double - ended,
for wire traction bows



23-109
Wire tightener, with
clamping jaws



23-110
Traction hook only,
large size



23-111
Traction hook only,
small size



23-112
Fixation clamp, to secure clamping
jaws of stainless steel

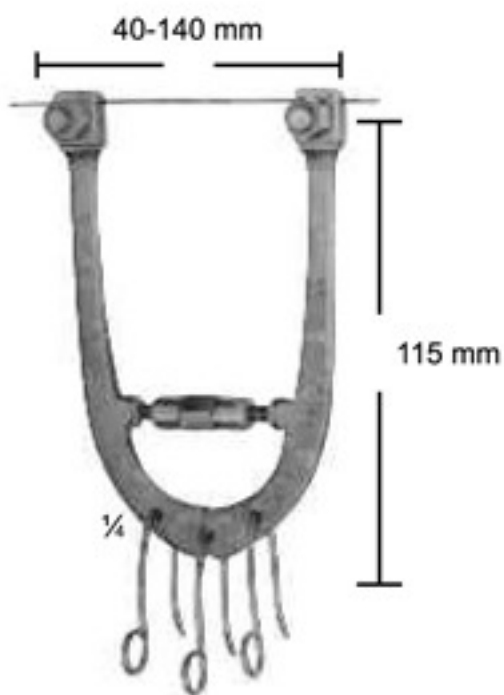

23-113
Wire traction bow, adjustable,
with 3 hooks, small size

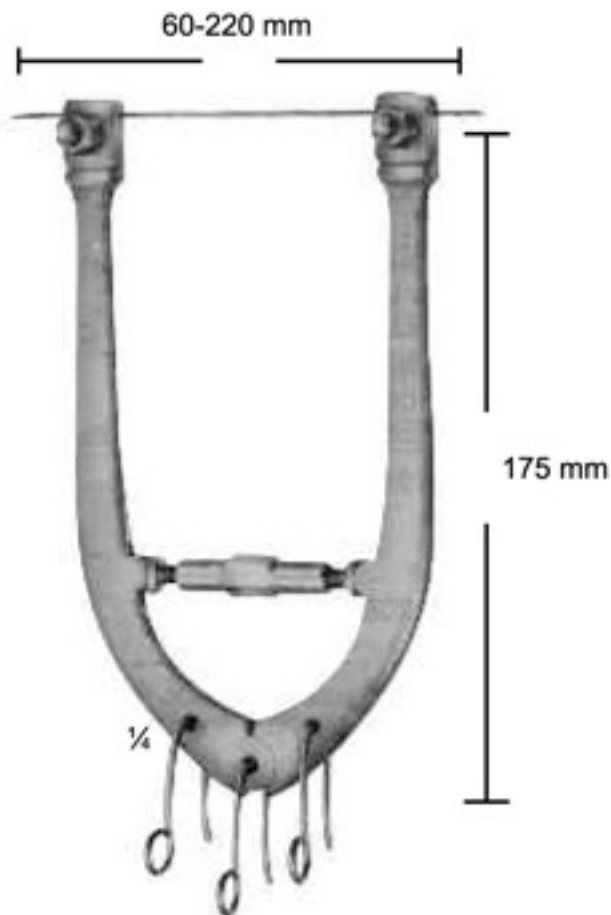

23-114
Wire traction bow, adjustable,
with 3 hooks, large size

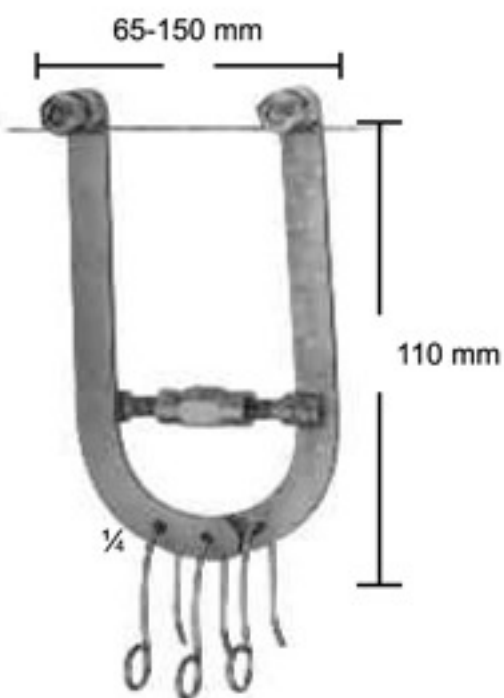

23-115
Wire traction bow, adjustable,
with 3 hooks, large size for
elbow and calcaneus, for
adolescents



23-116	105 mm
23-117	160 mm
23-118	200 mm
23-116	1,6 mm
23-117	2,0 mm
23-118	2,5 mm

23-116 - 118
KIRSCHNER
Wire traction bow, modified
adjustable in with width, holds wire
securely, with 1 hook



23-119
Fixation disc, slotted



23-121
Fixation disc, slotted



23-120
idem, aluminum, transparent
to X-rays



23-122
Screw driver, for above
fixations discs



23-123 - 130
Screw driver, for above fixations discs

Steinmann pins, 4 mm daim.		Steinmann pins, 5 mm daim.	
23-123 with pin		16x9cm	Arm
23-124 without pin	23-129 without		
23-125 with pin		21x11cm	Arm
23-126 without pin	23-130 without		
23-127 with pin		21x15cm	Arm
23-128 without pin			



23-131
SCHWARZ
Traction bow for fingers,
to be used with KIRSCHNER-
wire up to 1.6 mm diam.

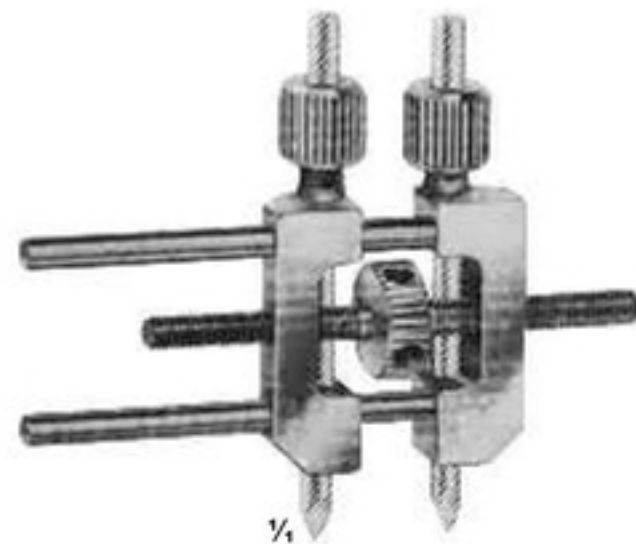

23-132
Small distractor
as a repositioning device for
distraction and compression of small bones,
for wires with 3.0 mm diam.



23-133 - 147
STEINMANN
 triangular shaft ended and trocar point

Length	4,0 mm	5,0 mm
80 mm	23-133	
100 mm	23-134	
120 mm	23-135	
140 mm	23-136	
150 mm	23-137	23-143
160 mm	23-138	
180 mm	23-139	23-144
200 mm	23-140	23-145
210 mm	23-141	
250 mm	23-142	23-146
300 mm		23-147



$\frac{1}{4}$
23-148
 Protection cap
 for 4,0 mm STEINMANN Pins



$\frac{1}{4}$
23-149
 Protection cap
 for 5,0 mm STEINMANN Pins



23-150
REILL
Drilling chuck, cannulated, for shanks from 2.0 - 2.5 mm diam 115 mm



23-151
Drilling chuck, cannulated, for shanks from 0.8 - 2.0 mm diam 150 mm



23-152
Drilling chuck, cannulated, for shanks up to 4.5 mm diam with key 140 mm



23-153
LOUTE
Wire tightener, improved pattern, with movable tip, for wires up to 1.0 mm diam. 220 mm



23-154
Drilling chuck, cannulated, for shanks up to 6.35 mm diam., To be tightened by hand 100 mm



23-155
Drilling chuck, cannulated, for shanks up to 4.5 mm diam., And for triangular shaft width across flats 4.7 mm



23-156
Drilling chuck, cannulated, for shanks up to 6.35 mm diam., With key 160 mm

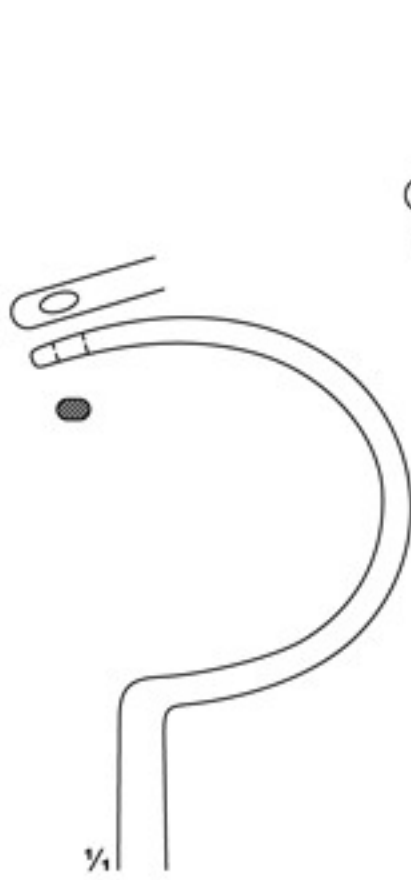

23-157
275 mm

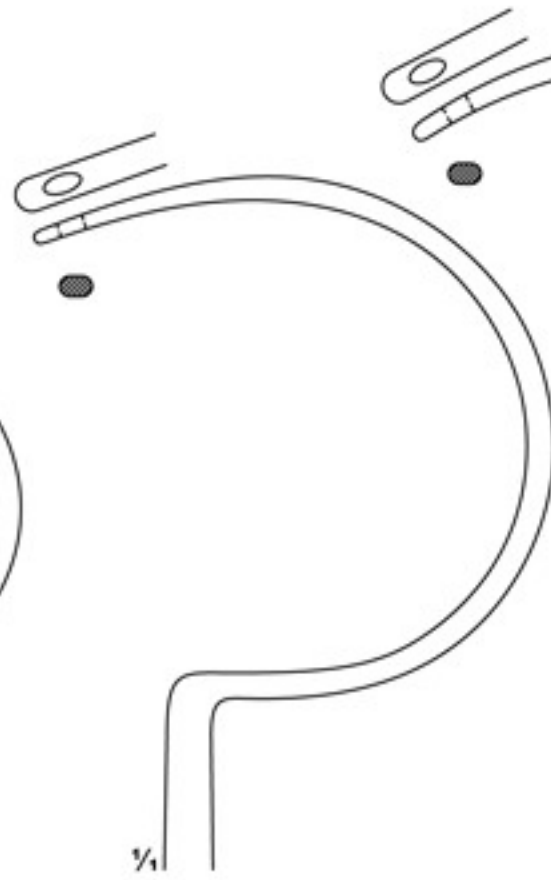

23-158
285 mm

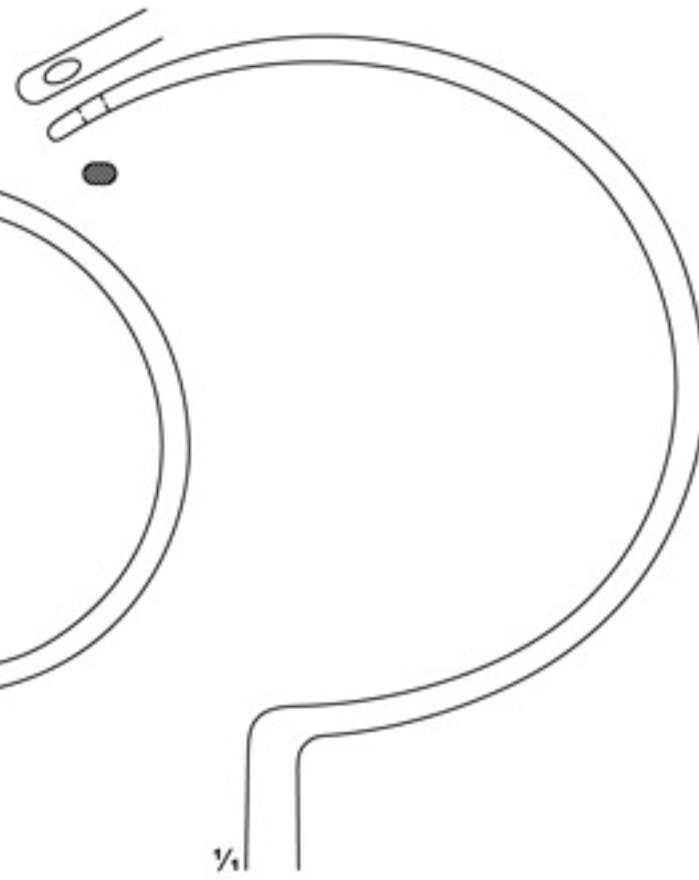

23-159
305 mm



23-157 - 159
DEMEL
Wire guides

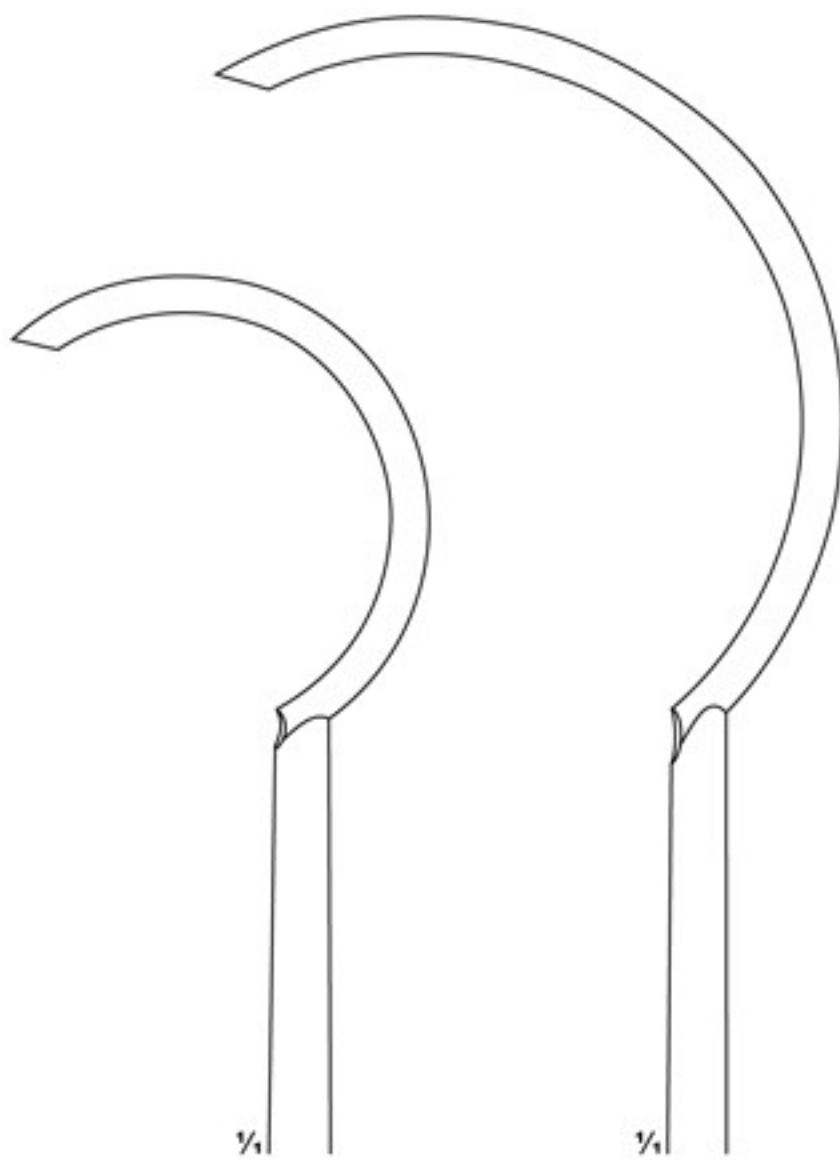

23-160
240 mm

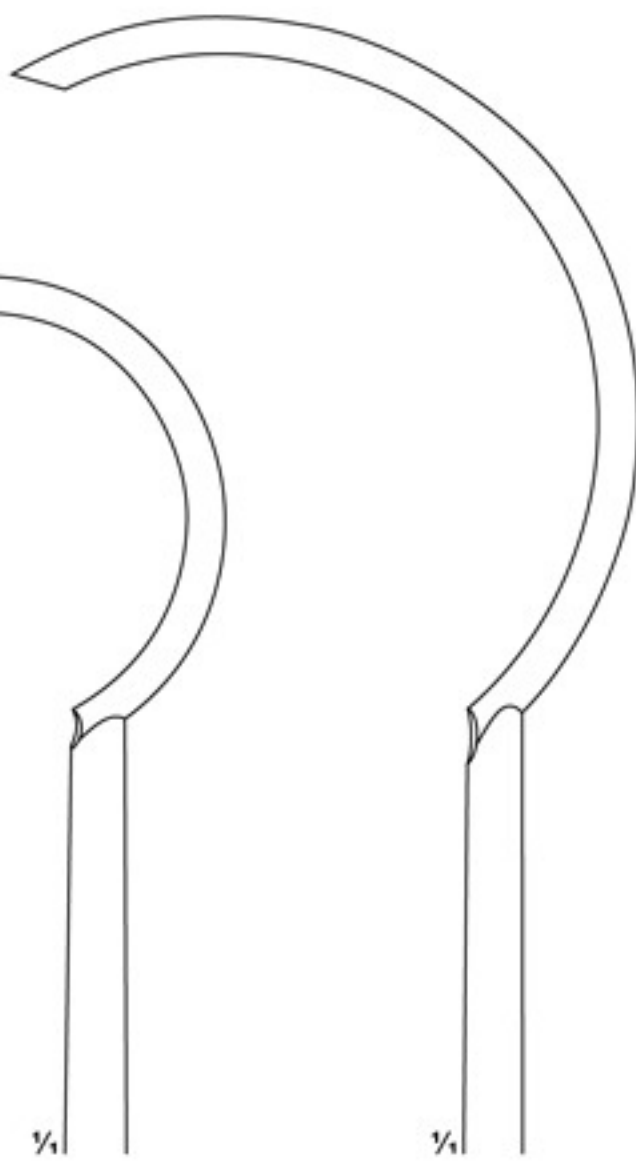

23-161
270 mm

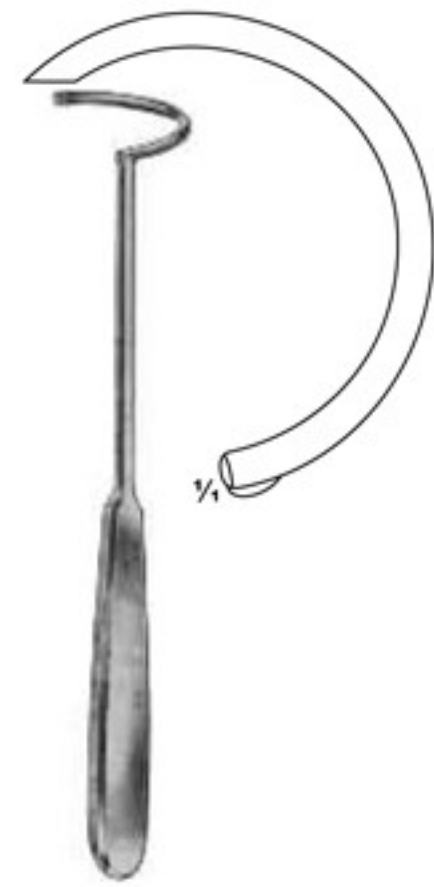

23-162
225 mm



23-163
JORDAN
Wire tightener



$\frac{1}{2}$
23-164
JORDAN
Wire twister
170 mm



$\frac{1}{2}$
23-165
JORDAN
Wire catcher
180 mm



$\frac{1}{2}$
23-166
JORDAN
Probe, cannulated
170 mm



23-167
DUROGRIP
Holding forceps for cerclage wire, with lateral jaws to avoid wire slipping off
170 mm



23-168
DUROGRIP
Wire, tightening pliers, Ligature pliers
150 mm



23-169
DUROGRIP
Wire, tightening pliers, Ligature pliers
150 mm



23-170
with serrated jaws
140 mm



23-171
one jaws smooth, one jaws serrated
140 mm



23-172
with serrated jaws
23-173
with longitudinal and transversal grooves
170 mm



23-174
190 mm

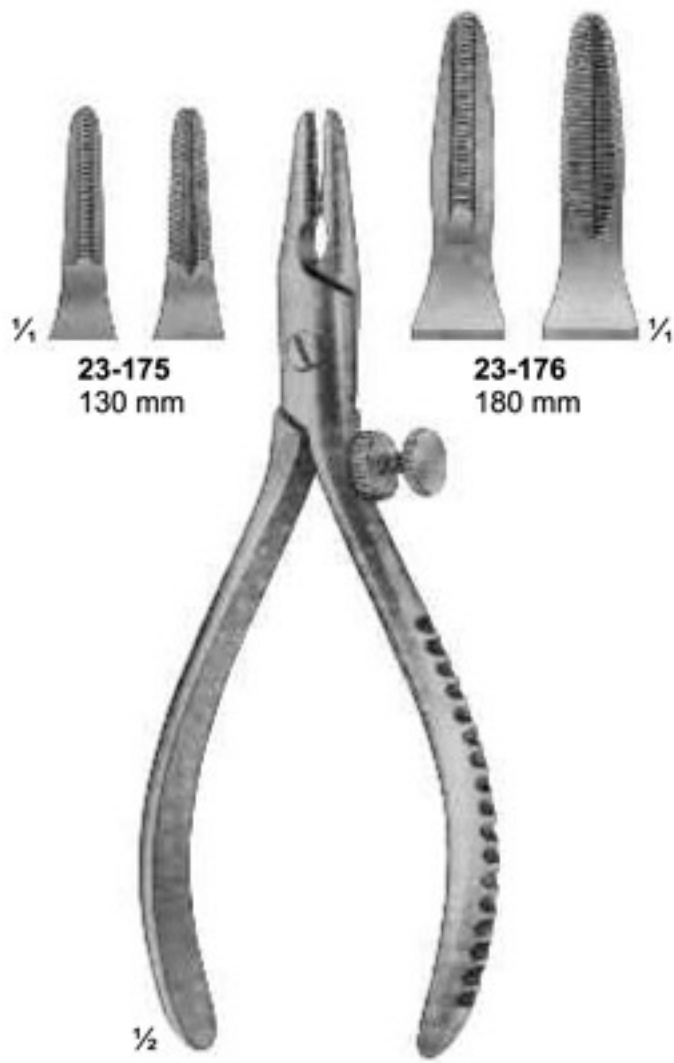

23-175 - 176
Extraction pliers
for boring wires



23-177
Flat-nosed pliers,
parallel
185 mm

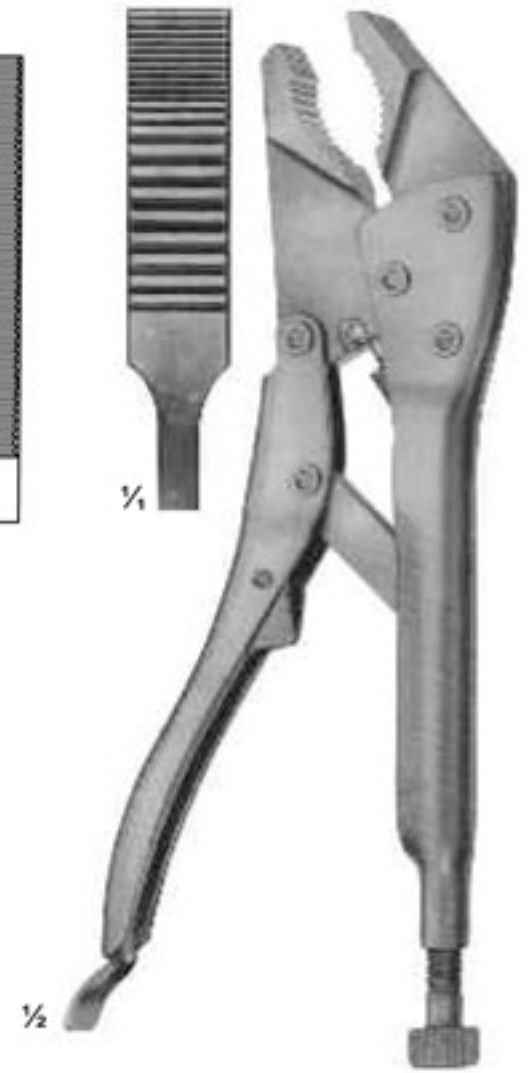

23-178
Vise grip
200 mm

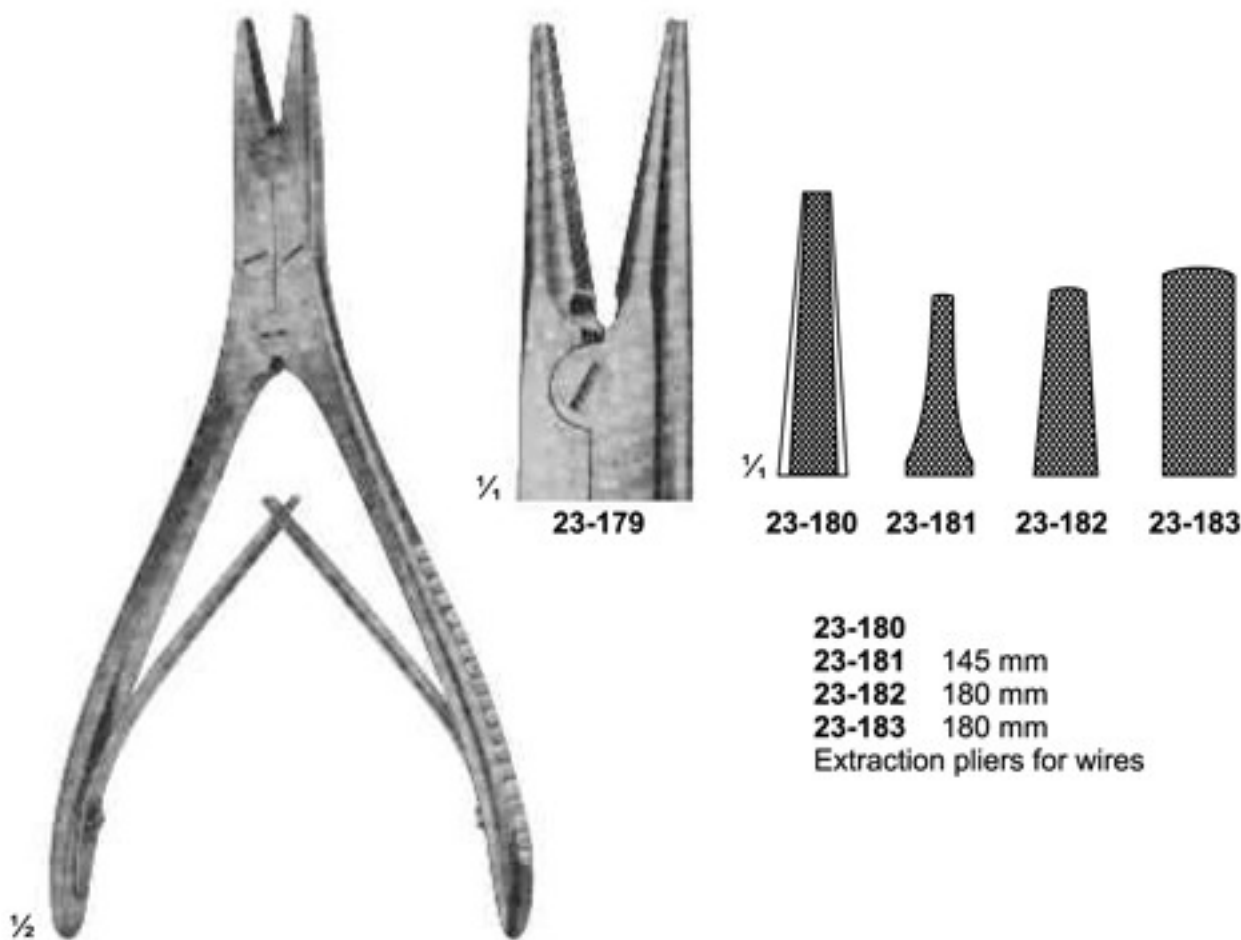

23-179 - 183
Round pliers
180 mm

23-180
23-181 145 mm
23-182 180 mm
23-183 180 mm
Extraction pliers for wires

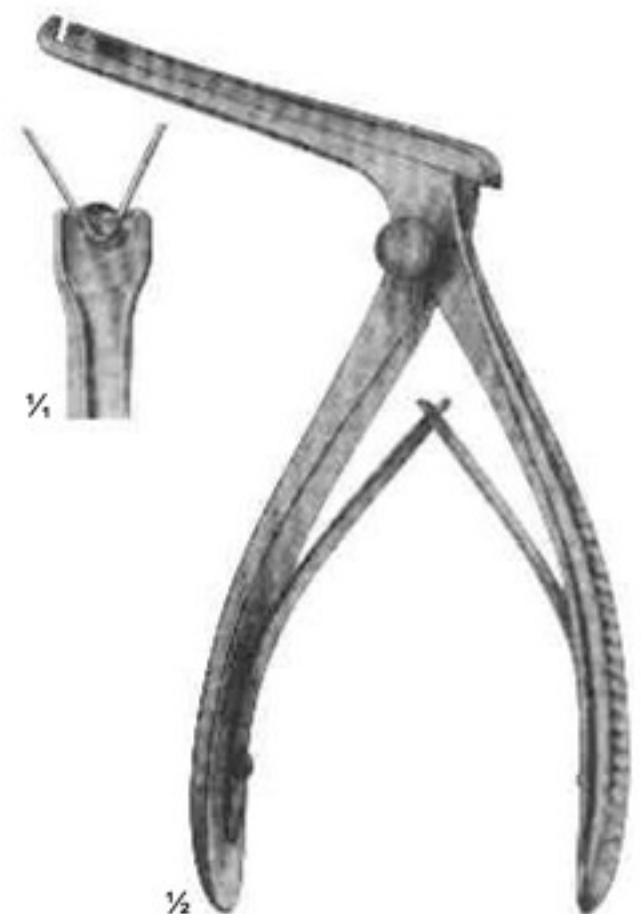

23-184
Bending pliers
for wires up to
1.8 mm diam.

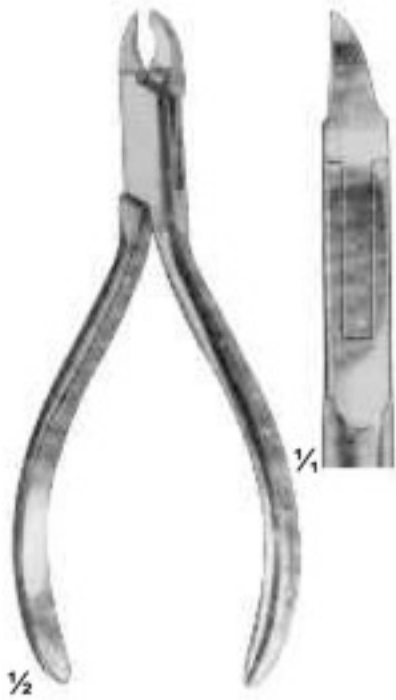

23-185
ANGLE
130 mm

23-186
DUROTIP
ANGLE
130 mm

for soft wire
up to diam.
for hard wire
up to diam.

0,5 mm	0,6 mm
0,3 mm	0,4 mm

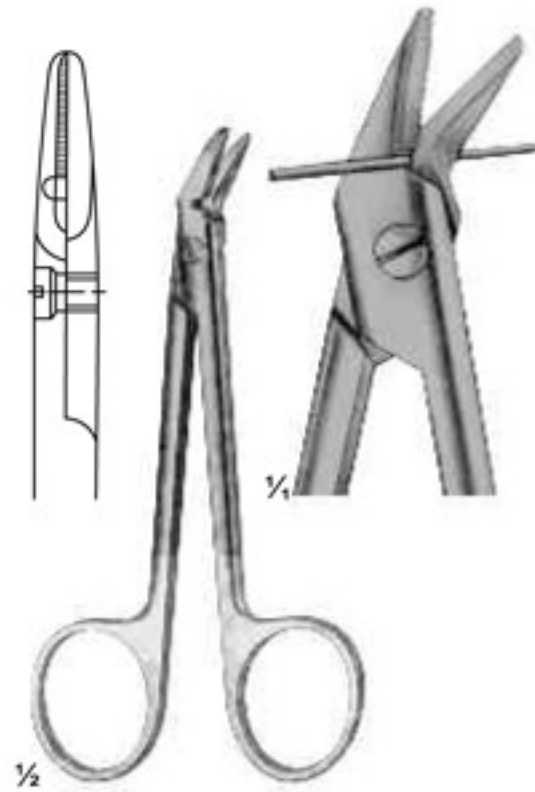

23-187
120 mm

23-188
DUROTIP
120 mm

for soft wire
up to diam.
for hard wire
up to diam.

1,2 mm	1,2 mm
0,8 mm	0,8 mm

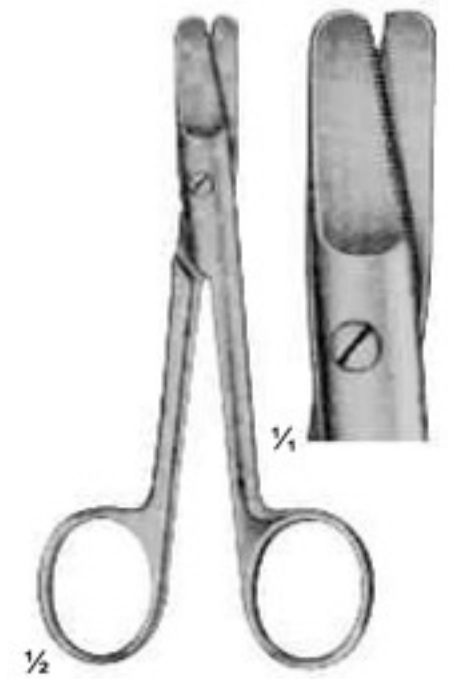

23-189
HARVEY
125 mm

0,4 mm
0,3 mm



23-190
150 mm

for soft wire
up to diam.
for hard wire
up to diam.

1,5 mm
1,0 mm



23-191
160 mm

1,5 mm
1,2 mm



23-192
140 mm

1,5 mm
1,0 mm



23-193
180 mm

for soft wire
up to diam. 2,0 mm
For hard wire 1,5 mm
up to diam
specially hardened
cutting edges, front
and lateral cutting
action

23-194
REILL
175 mm

for soft wire
up to diam. 2,0 mm
For hard wire 1,6 mm
up to diam
specially hardened
cutting edges, for
cutting off wires close
to the bone

23-195
235 mm

for soft wire
up to diam. 3,0 mm
For hard wire 2,2 mm
up to diam

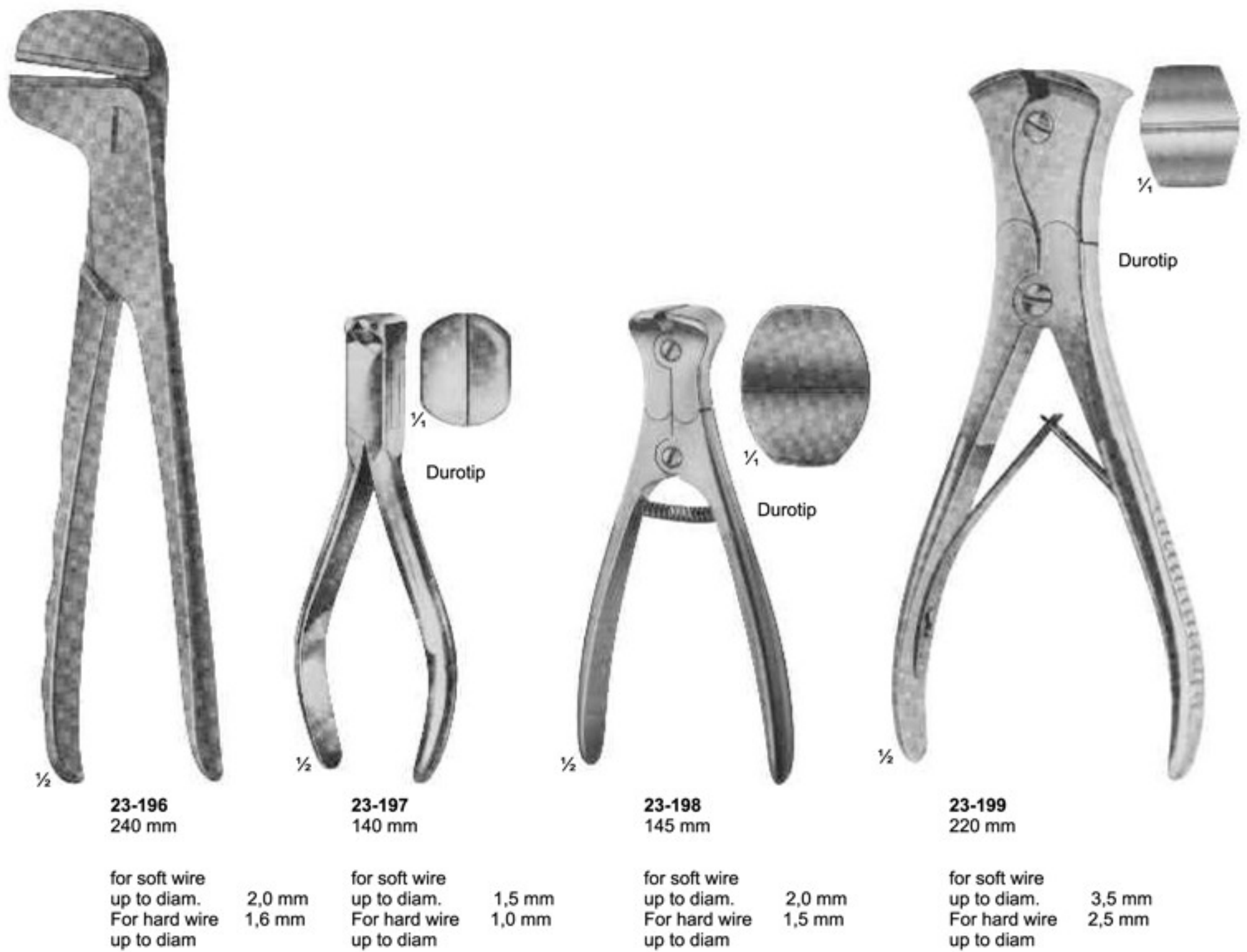



Cutter for cutting off
KIRSCHNER wires,
Tibia head screws,
bolts, pins, up to 3 mm diam.

1/4



Durotip

23-200
320 mm

for soft wire up to diam. 3,0 mm
For hard wire up to diam 3,0 mm

23-201
Cutter for cutting off
KIRSCHNER wires,
Tibia head screws,
bolts, pins, up to 6 mm diam.
470 mm

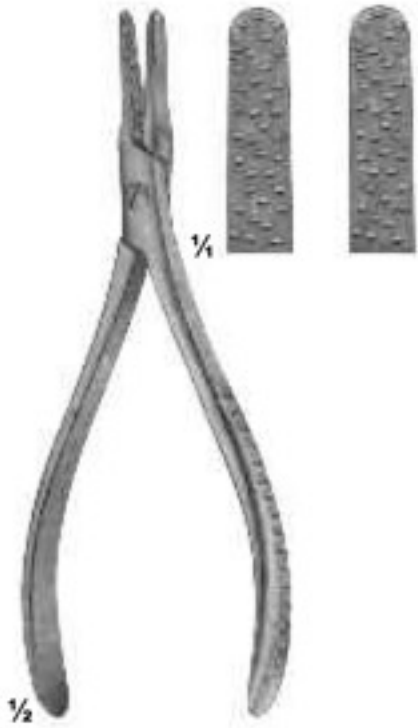

23-202
Nail extracting
forceps
135 mm



23-203
Nail extracting
forceps
145 mm

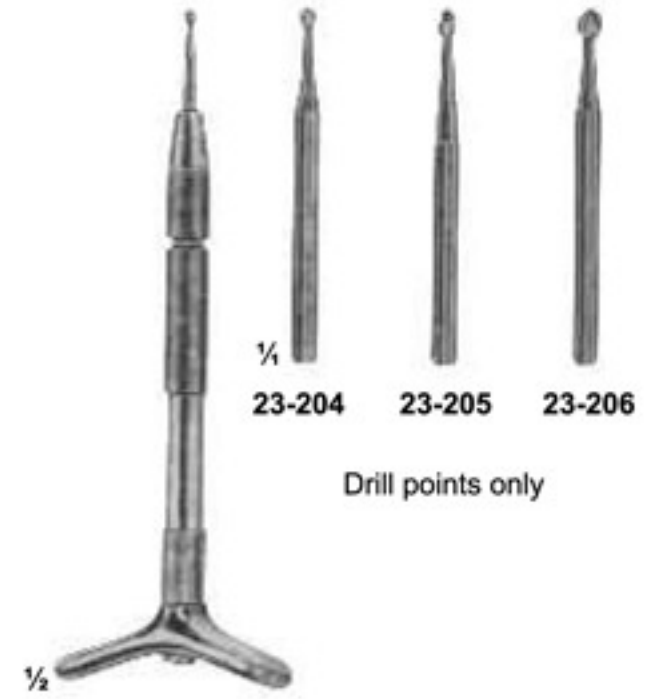

23-204 - 206
Finger nail drill
with 3 points

Drill points only

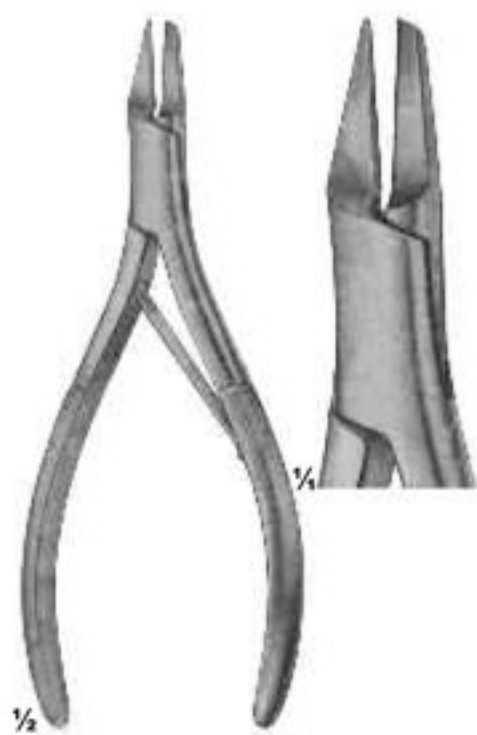

23-207
Nail splitting
forceps
135 mm



23-208
SYSTRUNK
Scissors, for splitting
finger nails
130 mm

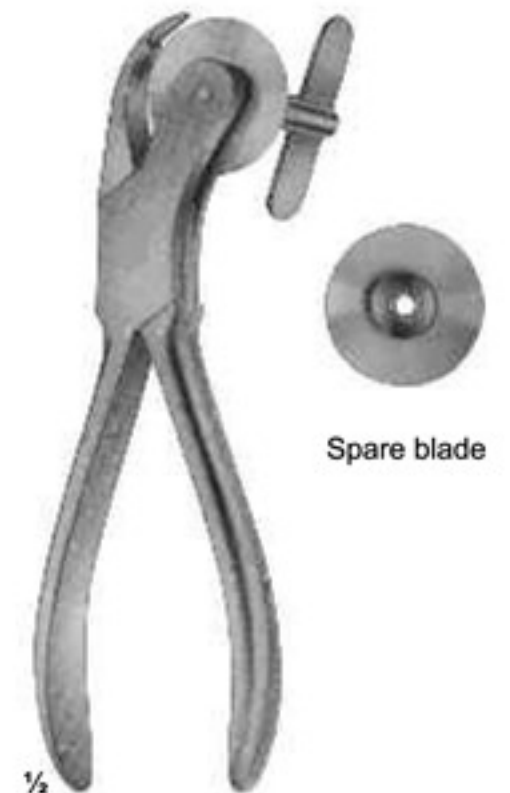

23-209
Finger ring saw
150 mm

Spare blade



with ebony handle

24-101
HOPKINS
200 mm



24-102
ESMARCH
180 mm



24-103
ENGEL
160 mm



24-104 - 112

- | | | | |
|--------|-------|--------|-------------|
| 24-104 | black | 24-108 | yellow |
| 24-105 | red | 24-109 | white |
| 24-106 | blue | 24-110 | orange |
| 24-107 | green | 24-111 | lavender |
| | | 24-112 | bright pink |



24-113 - 121

- | | | | |
|--------|-------|--------|-------------|
| 24-113 | black | 24-117 | yellow |
| 24-114 | red | 24-118 | white |
| 24-115 | blue | 24-119 | orange |
| 24-116 | green | 24-120 | lavender |
| | | 24-121 | bright pink |

For small plaster dressings

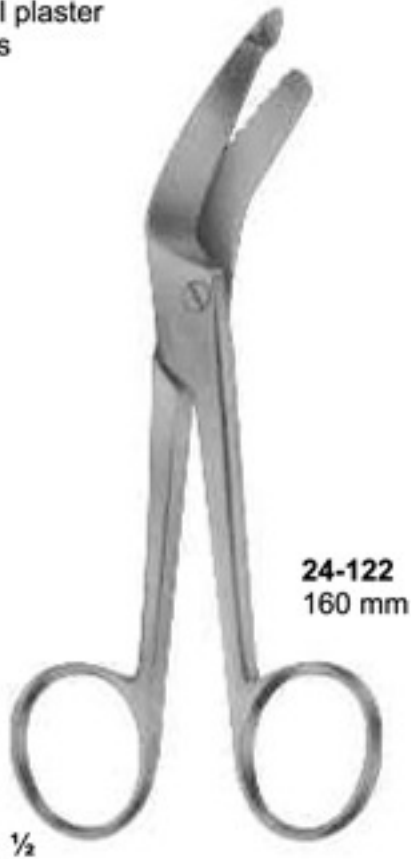



24-129
STILLE-AESULAP
260 mm



24-130
STILLE-AESULAP
360 mm

Blade with reinforced back



24-131
STILLE
230 mm

24-132
Spare blade



24-133
STILLE
370 mm

24-134
Spare blade



24-135
STILLE
240 mm

24-136
Spare blade



24-137
HENING
270 mm



24-138
MOD.USA
230 mm



24-139
290 mm



with removable jaws



24-140 - 141
WOLFF
24-140 180 mm
24-141 240 mm

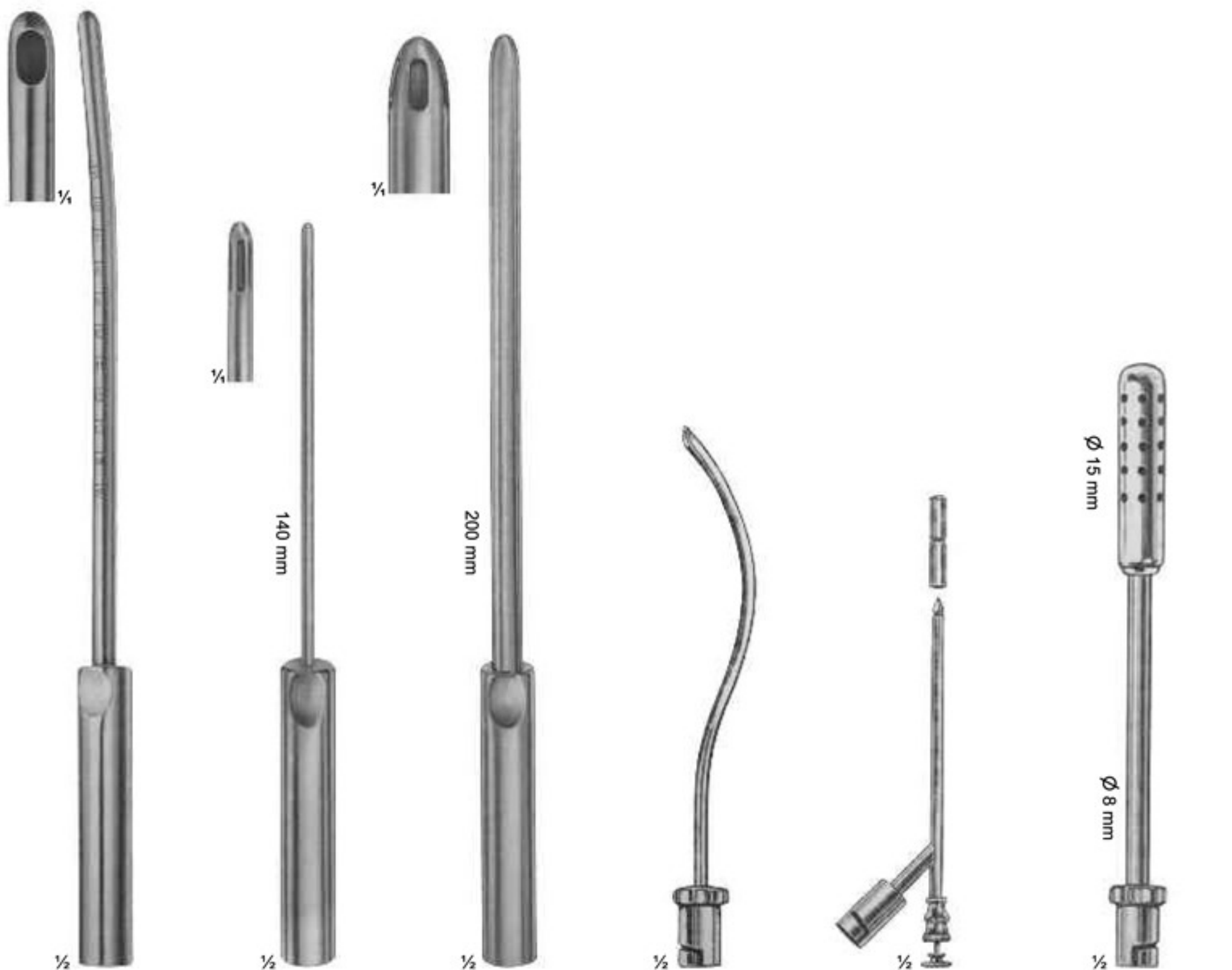

25-101 - 106
BIEMER
25-101 ø 4 mm
25-102 ø 6 mm
25-103 ø 8 mm
25-104 ø 10 mm
25-105 ø 12 mm
25-106 ø 14 mm
Curettes for aspiration lipectomy, graduated, slightly curved

25-107 - 108
BIEMER
25-107 ø 4 mm
25-108 ø 6 mm
Curettes for aspiration lipectomy, with three apertures, slightly curved malleable

25-109 - 111
BIEMER
25-109 ø 8 mm
25-110 ø 10 mm
25-111 ø 12 mm
Curettes for aspiration lipectomy, with three apertures, slightly curved malleable

25-112
For aspirating fluid from the excretory ducts of large glands and for keeping the operating area clear
170 mm

25-113
Trocar
For puncturing
150 mm

25-114
For clearing large quantities of fluid
190 mm



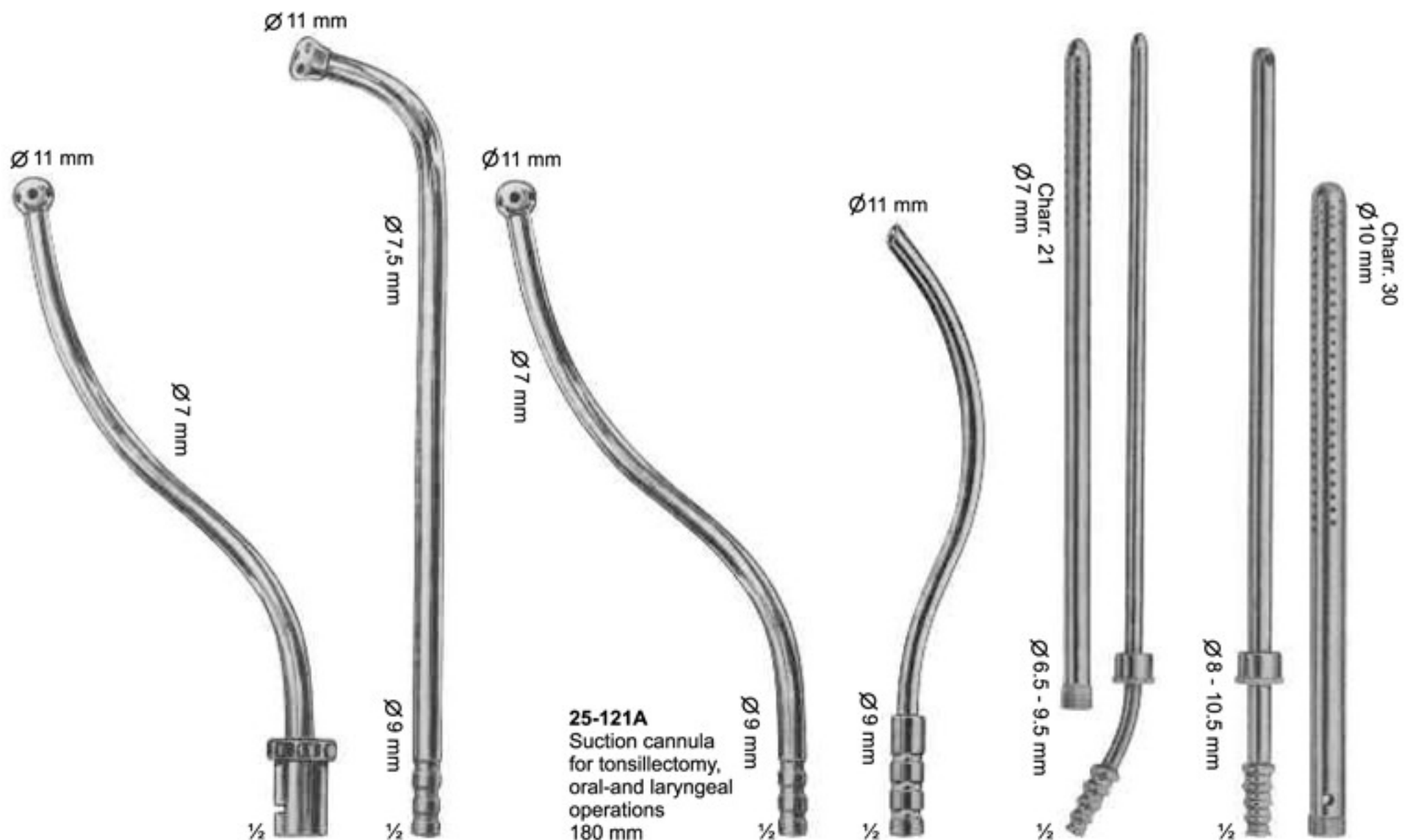

25-120
For tonsillectomy,
oral-and laryngeal
operations
180 mm

25-121
Suction cannula
for tonsillectomy,
oral-and laryngeal
operations
220 mm

25-121A
Suction cannula
for tonsillectomy,
oral-and laryngeal
operations
180 mm

25-122
S-shaped blunt cannula
for aspirating fluid from
the excretory ducts of
large glands and for
keeping the operations
area clear
170 mm

25-123
POOL
Suction cannula,
with outer tube
to be screwed of
225 mm

25-124
POOL
Suction cannula,
with outer tube
to be screwed of
225 mm

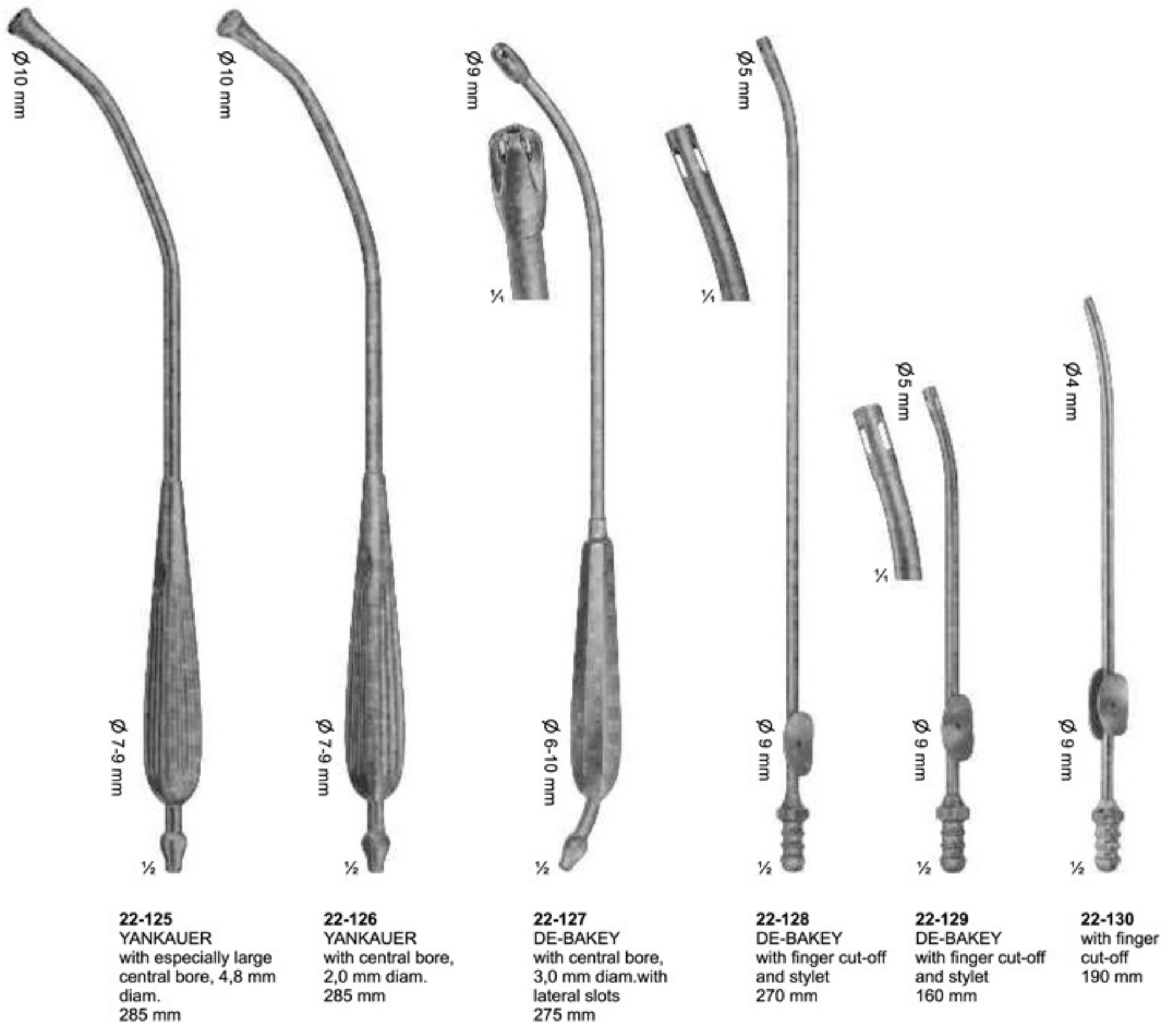

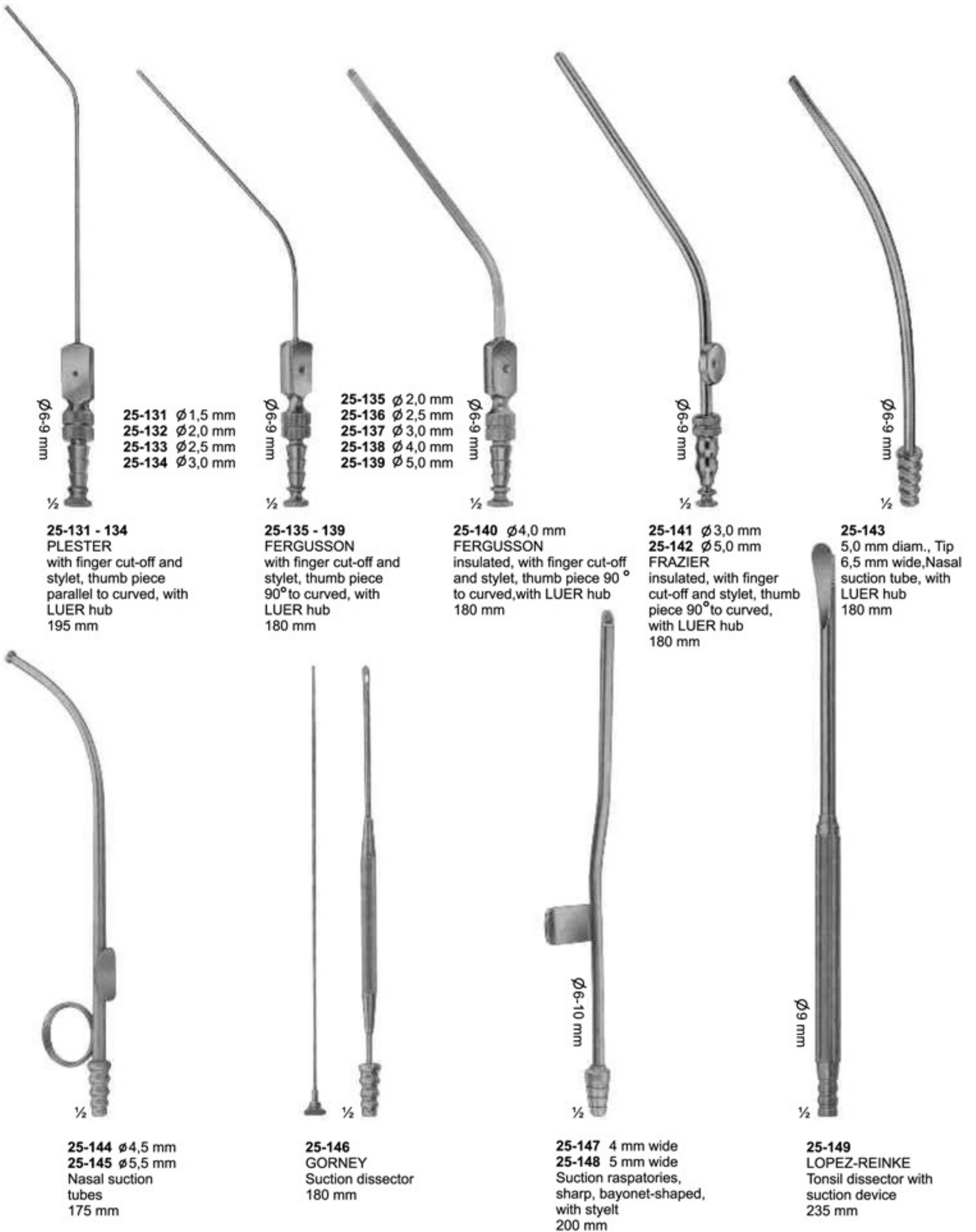

25-150
WULLSTEIN
Suction tube, conical, silver, oliver
with LUER hub
160 mm

$\varnothing 1,75$ mm

$\varnothing 3$ mm
 $\frac{1}{2}$
 $\varnothing 8$ mm

25-151 1,5 mm
25-152 2,0 mm
WULLSTEIN
Suction tube, cylindrical, silver, with
stylet with LUER hub
160 mm

$\frac{1}{2}$
 $\varnothing 8$ mm

Usable length

YASARGIL usable length diam.		YASARGIL usable length diam.	
25-153	130 mm 1,5 mm	25-161	130 mm 2,5 mm
25-154	150 mm 1,5 mm	25-162	150 mm 2,5 mm
25-155	180 mm 1,5 mm	25-163	180 mm 2,5 mm
25-156	220 mm 1,5 mm	25-164	220 mm 2,5 mm
25-157	130 mm 2,0 mm	25-165	130 mm 3,5 mm
25-158	150 mm 2,0 mm	25-166	150 mm 3,5 mm
25-159	180 mm 2,0 mm	25-167	180 mm 3,5 mm
25-160	220 mm 2,0 mm	25-168	220 mm 3,5 mm
		25-169	180 mm 4,5 mm

$\varnothing 6,5-9$ mm
with LUER hub

25-170 - 172
LANDOLT
150 MM
diam $\varnothing 3$ mm

25-170 8 mm / curved
25-171 11mm / curved
25-172 15mm / curved

$\varnothing 3,5$ mm

$\varnothing 2,0$ mm

25-173 500 mm
25-174 350 mm
with rubber tip,
with LUER hub

$\varnothing 9$ mm
 $\frac{1}{2}$

25-175 2,0 mm diam
25-176 2,5 mm diam
25-177 3,0 mm diam
with finger cut-off,
thumb piece 90° to
curved, with LUER hub
250 mm

$\varnothing 6-9$ mm
 $\frac{1}{2}$



25-179
YASARGIL
LURE-LOCK cone
200 mm

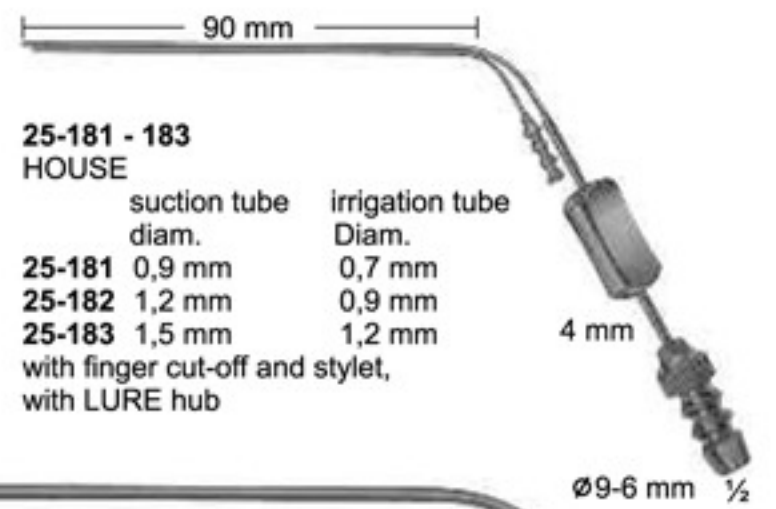
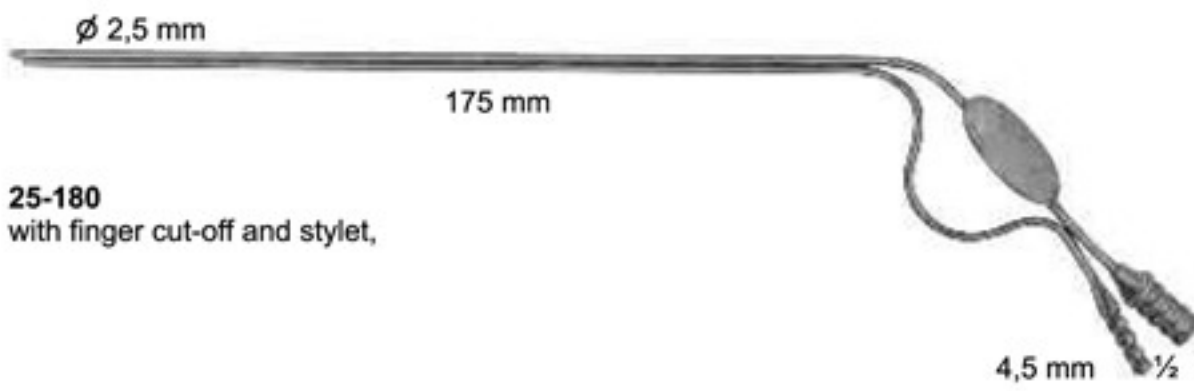

25-181 - 183
HOUSE

	suction tube diam.	irrigation tube Diam.
25-181	0,9 mm	0,7 mm
25-182	1,2 mm	0,9 mm
25-183	1,5 mm	1,2 mm

with finger cut-off and stylet,
with LURE hub

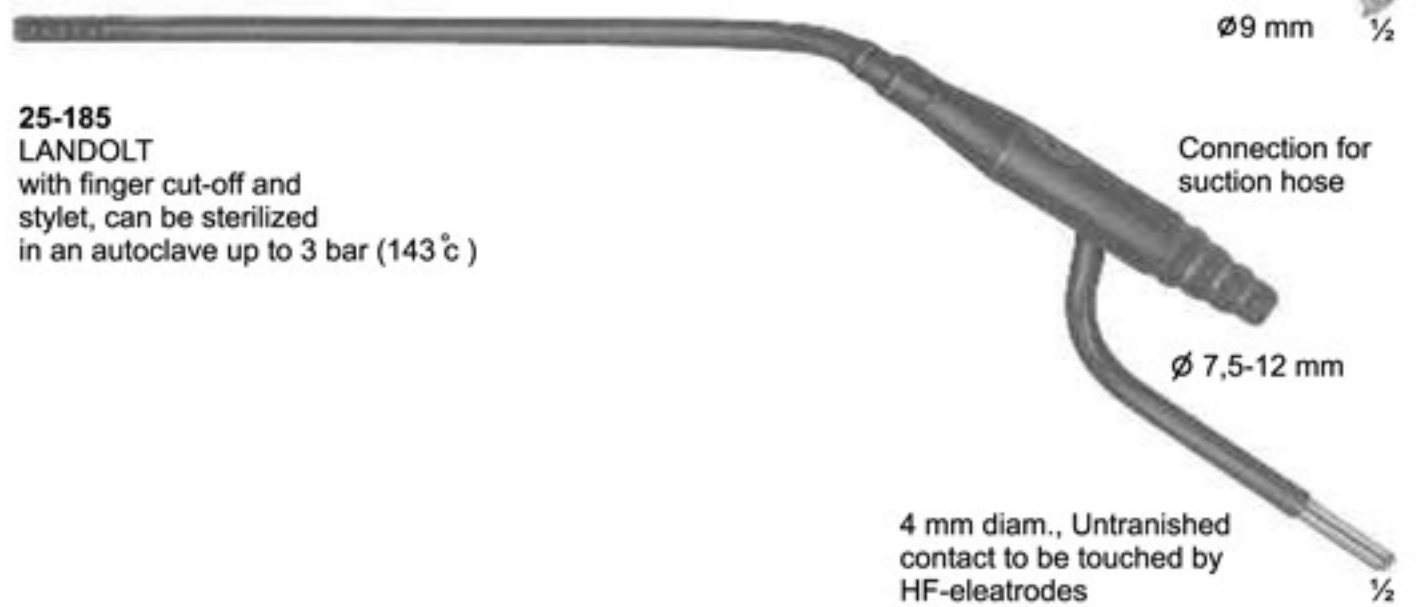
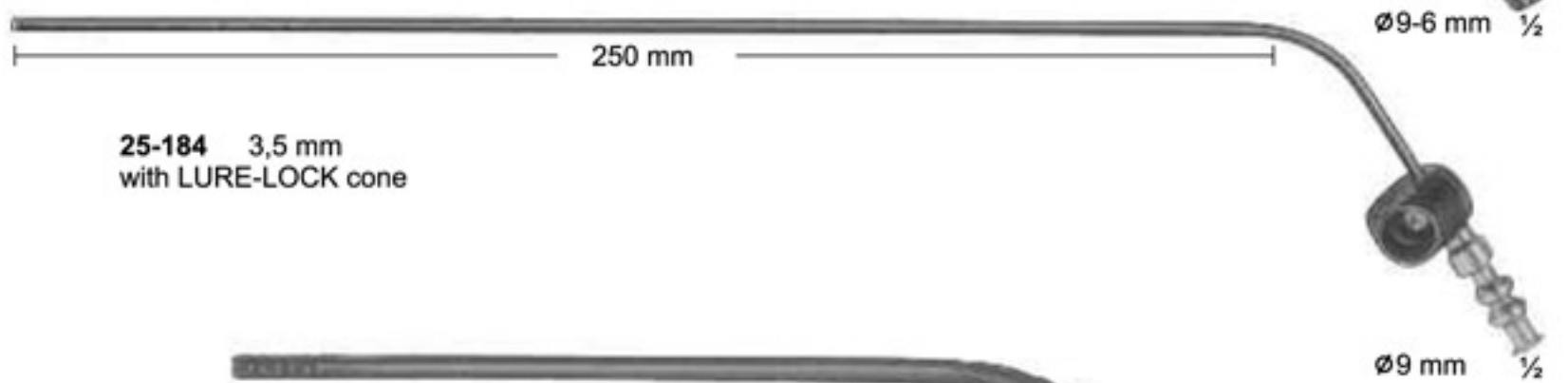



26-101
Standard

14,5cm
16,5cm
18,5cm



26-102
Standard

14,5cm
16,5cm
18,5cm



26-103
Standard

14,5cm
16,5cm
18,5cm



26-104
Standard

14,5cm
16,5cm
18,5cm



26-105
Standard

14,5cm
16,5cm
18,5cm



26-106
Standard

14,5cm
16,5cm
18,5cm

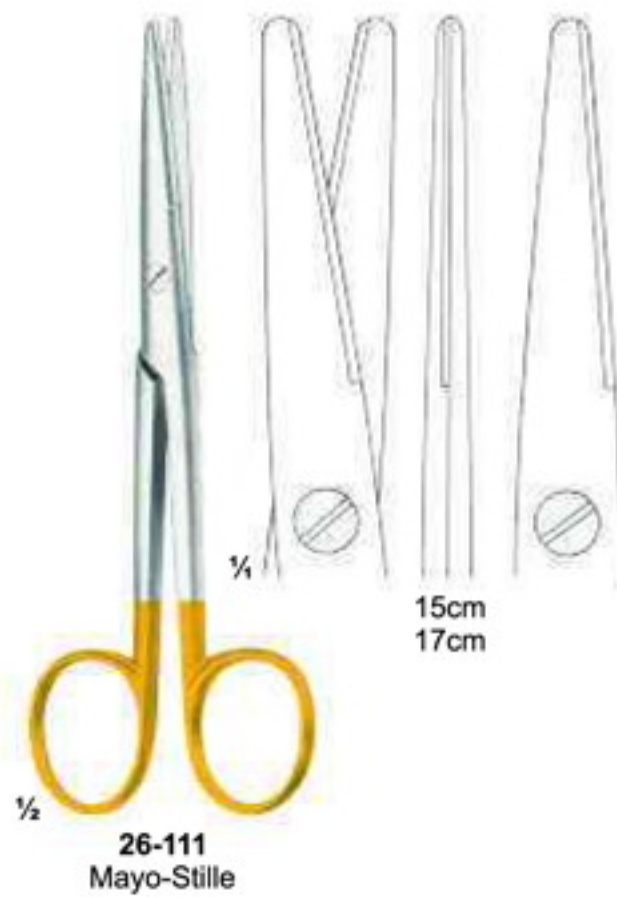



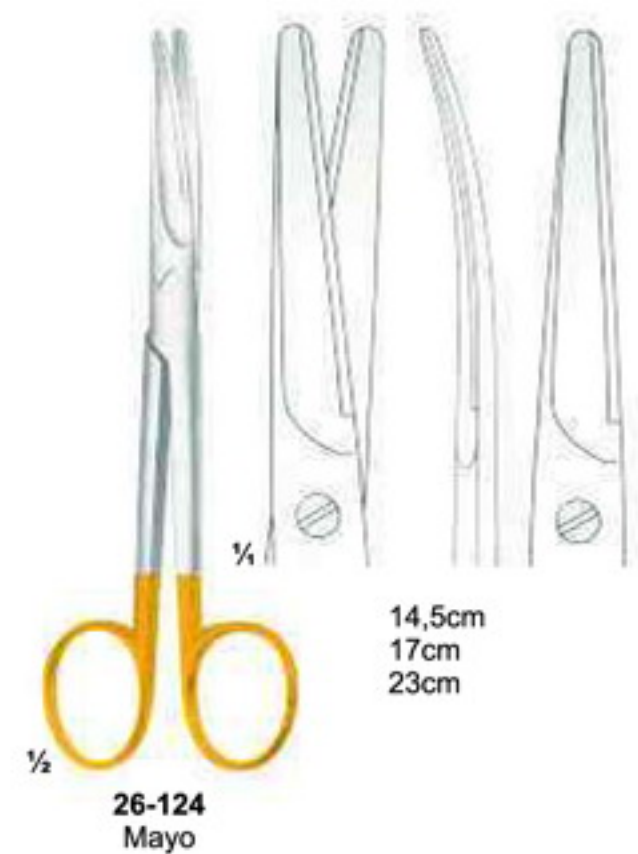
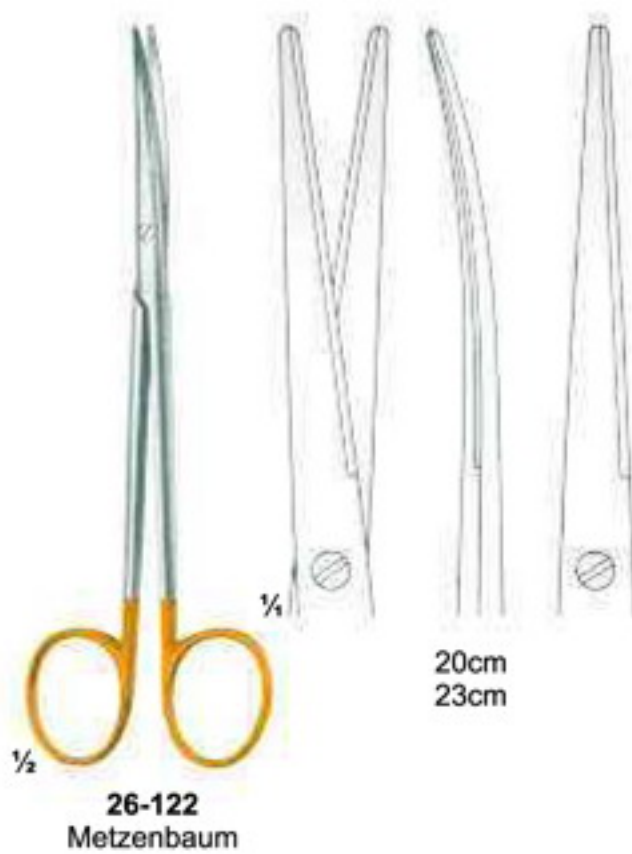
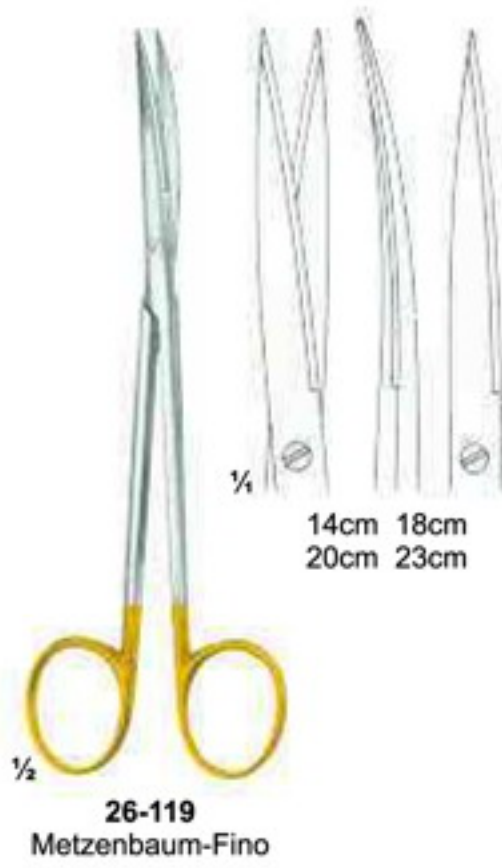



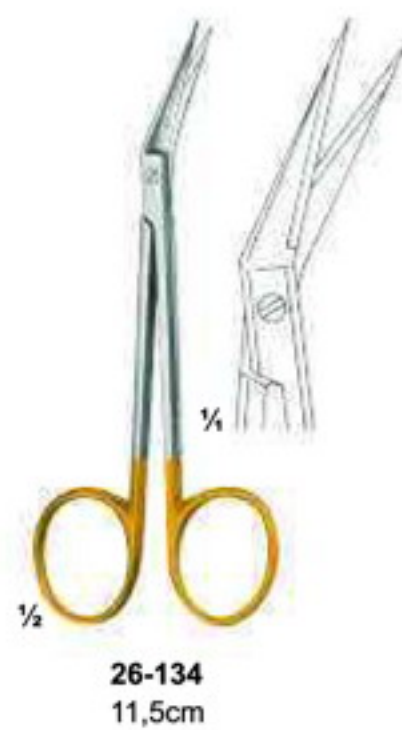
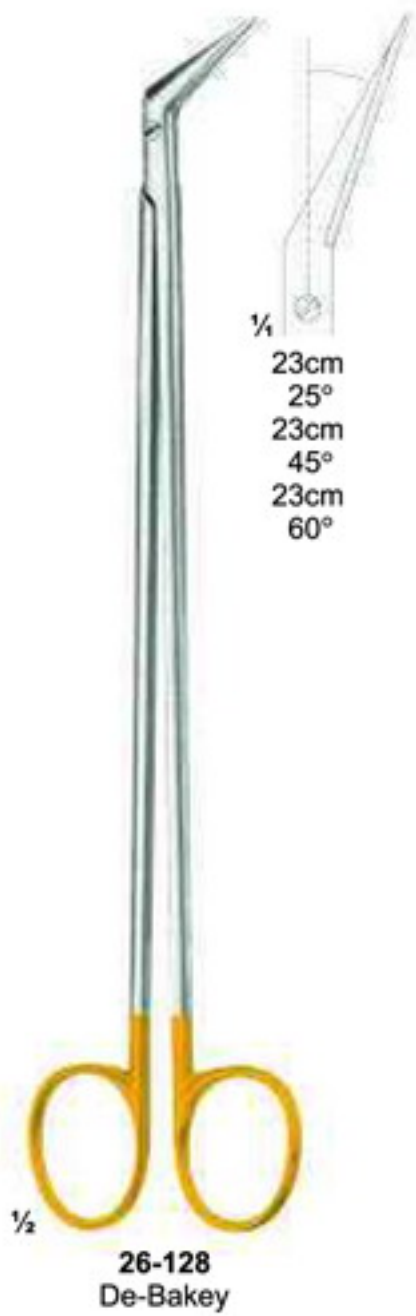

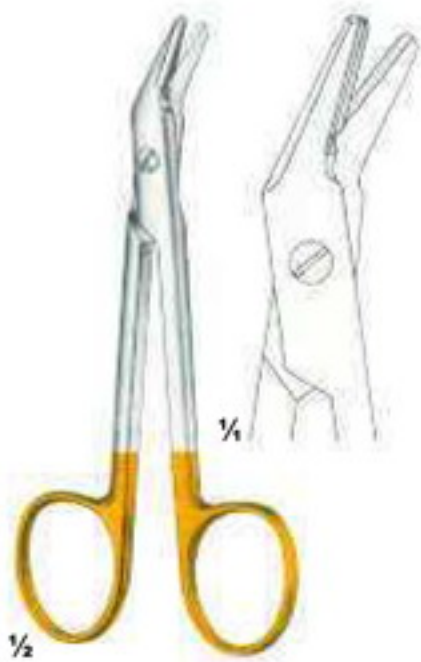

26-136
Universal
12cm



26-137
Ligature Scissors
1 Black & 1 Goldplated ring



26-138
Adson



26-139
Cushing
17,5cm



26-140
Cushing
18cm



26-141
Cushing-Taylor
18cm



26-142
Dissecting Forceps
15cm



26-143
Semken
15cm

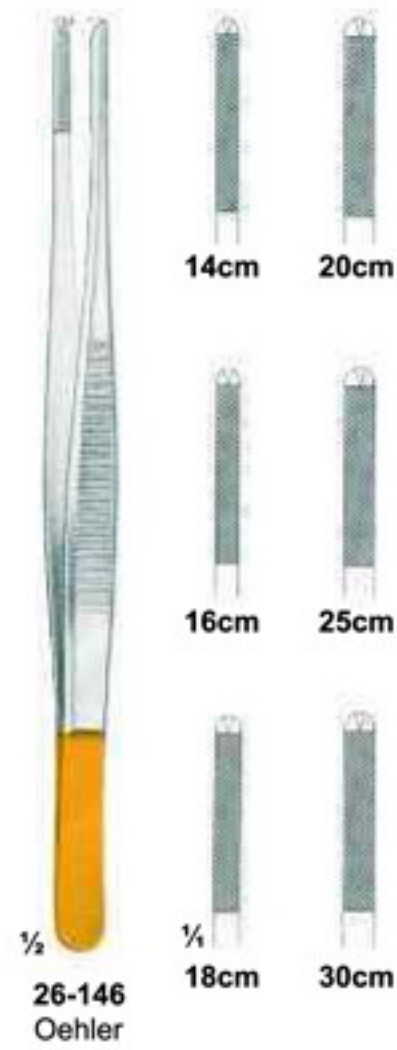
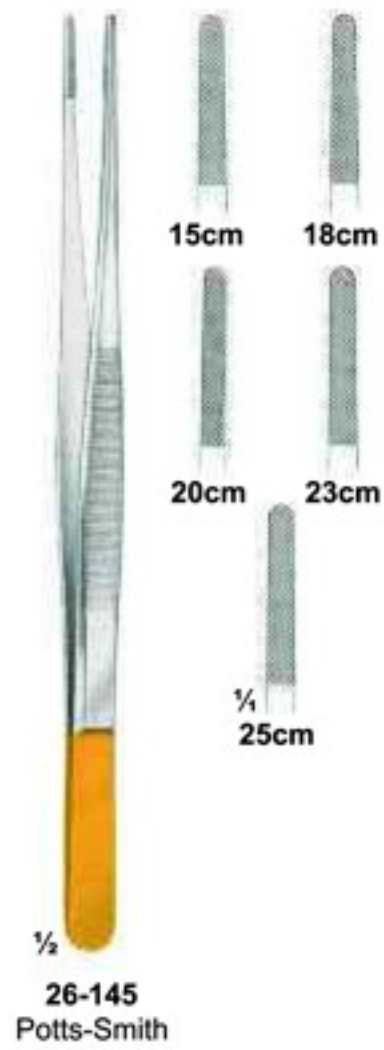



26-152
Arruga
16cm



26-153
Castroviejo
13cm



26-154
Hegar
20cm 24cm

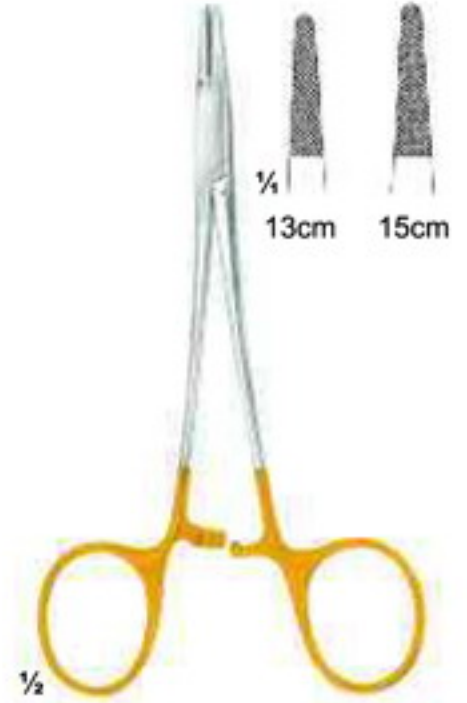

26-155
Halsey
13cm 15cm

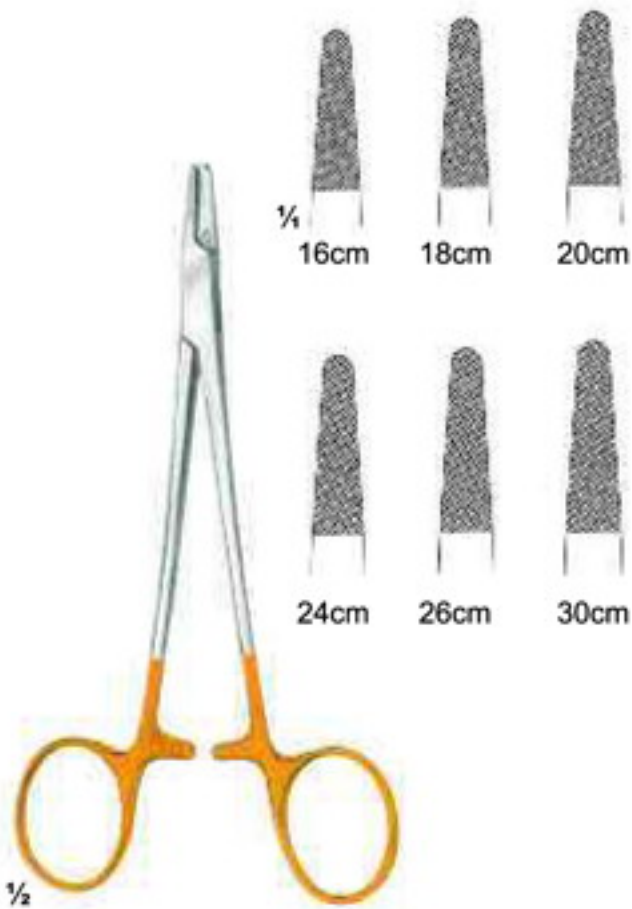

26-156
Mayo-Hegar
16cm 18cm 20cm
24cm 26cm 30cm

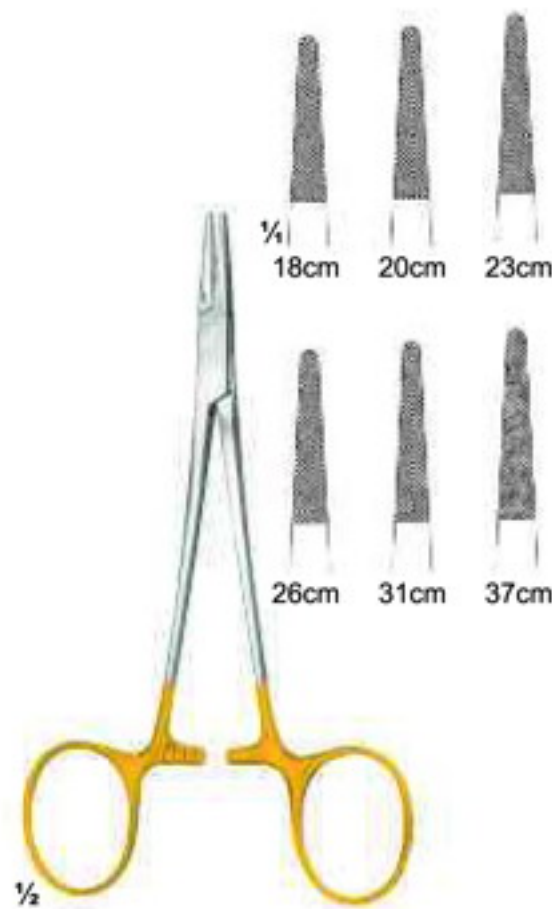

26-157
De-Bakey
18cm 20cm 23cm
26cm 31cm 37cm



26-158
Hegar-Vascular
14cm 18cm
20cm 23cm

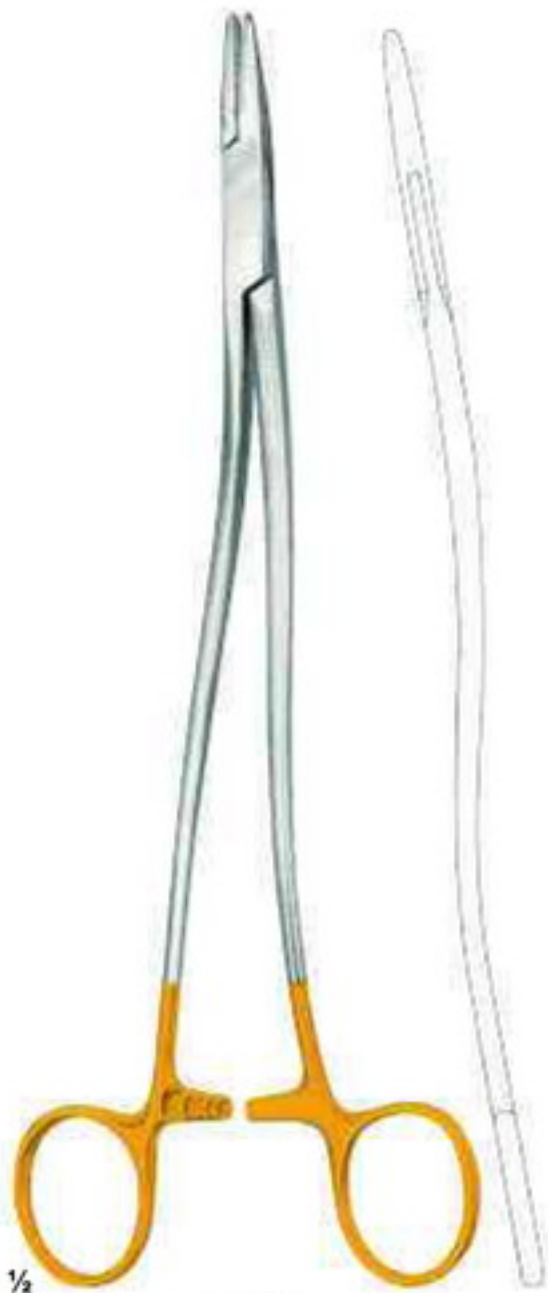

$\frac{1}{2}$
26-159
 Bozemann-Wertheim
 20cm 24cm 26cm



$\frac{1}{2}$
26-160
 Stratte
 22cm 23cm

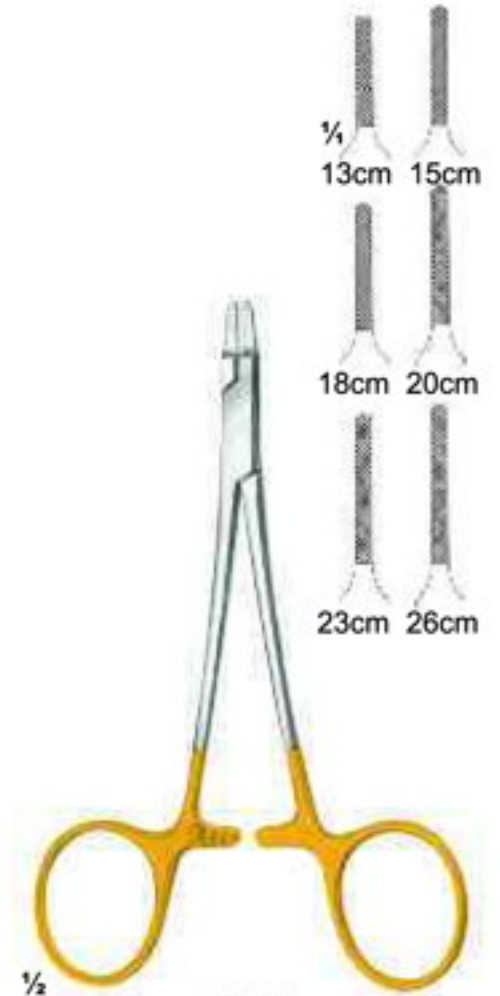

$\frac{1}{2}$
26-161
 Ryder
 13cm 15cm 18cm
 20cm 23cm 26cm



$\frac{1}{2}$
26-162
 Ryder-Vascular
 13cm 15cm 18cm
 20cm 23cm 26cm



$\frac{1}{2}$
26-163
 Martin
 15cm 17cm 20cm

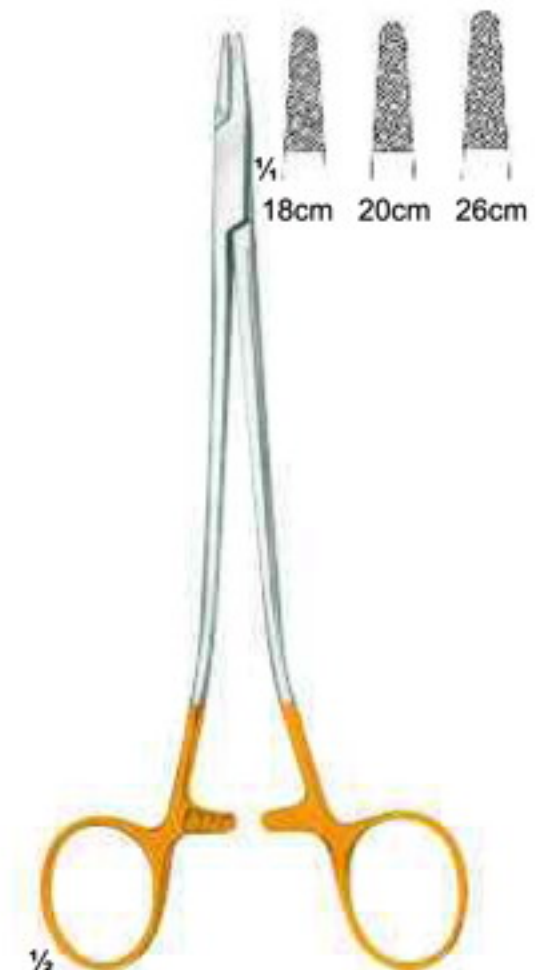

$\frac{1}{2}$
26-164
 Sarot
 18cm 20cm 26cm





1/2
26-172
Mathieu-Ryder
17cm
20cm 24cm



1/2
26-173
Lichtenberg
20cm



1/2
26-174
Langhals
20cm 25cm



1/2
26-175
Lichtenberg
20cm 25cm



1/2
26-176
Luehty-Beck
20cm 25cm



1/2
26-177
Luehty-Beck
20cm 25cm



1/2
26-178
Langebeck
18cm
20cm 23cm



1/2
26-179
Langebeck-beck
18cm
20cm 23cm



27-101 - 115
Schimmelbusch

	Ø x H sizes in mm
27-101	80 x 80
27-102	105 x 120
27-103	140 x 140
27-104	160 x 120
27-105	160 x 150
27-106	190 x 150
27-107	190 x 190
27-108	240 x 160
27-109	240 x 240
27-110	290 x 160
27-111	290 x 240
27-112	340 x 160
27-113	340 x 340
27-114	390 x 190
27-115	390 x 290



27-116
Box
120 x 65 x 13mm
(without Bulldog clamps,
without silicone tape)



27-117
Box with support
120 x 65 x 13 mm
(ohne Bulldogklemmen)



27-118
Box with support for
needle electrodes,
without instruments



27-119 - 121
50 x 25 x 4,5 mm
27-120
65 x 42 x 8 mm
27-121
75 x 25 x 4,5 mm



27-122
Ø 65mm x 15mm



27-123 - 131

	Ø x H
27-123	30 x 90 mm
27-124	50 x 100 mm
27-125	50 x 130 mm
27-126	50 x 175 mm
27-127	75 x 100 mm
27-128	75 x 130 mm
27-129	75 x 175 mm
27-130	100 x 175 mm
27-131	100 x 200 mm



27-132 - 139

27-132	165 x 85 x 35	mm
27-133	200 x 100 x 35	mm
27-134	200 x 100 x 50	mm
27-135	230 x 130 x 50	mm
27-136	260 x 150 x 50	mm
27-137	270 x 235 x 50	mm
27-138	300 x 200 x 50	mm
27-139	325 x 275 x 50	mm

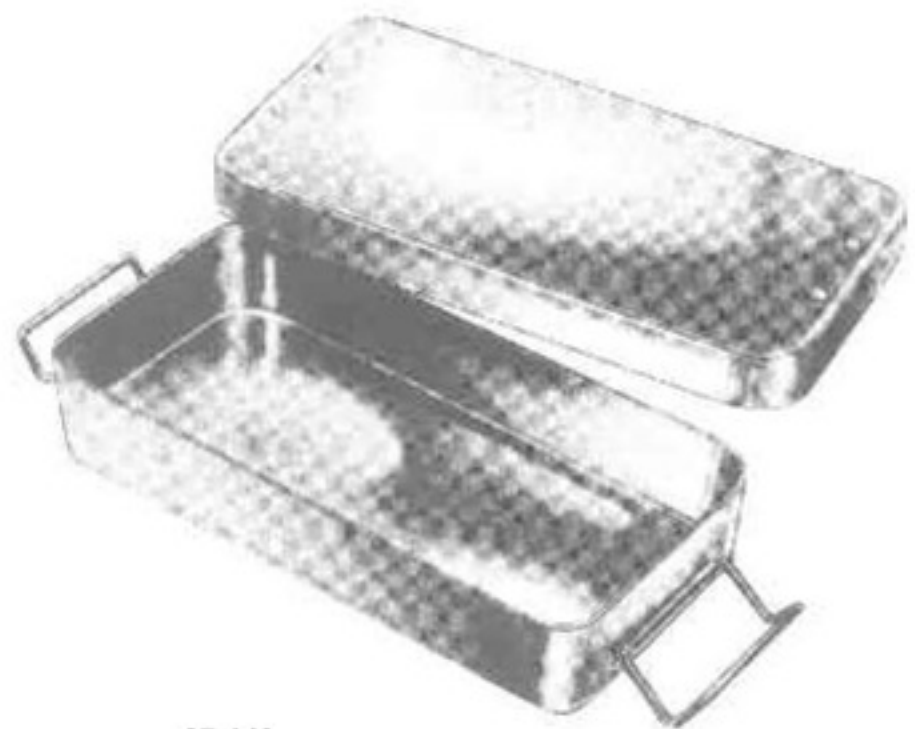

27-140
205 x 105 x 35 mm

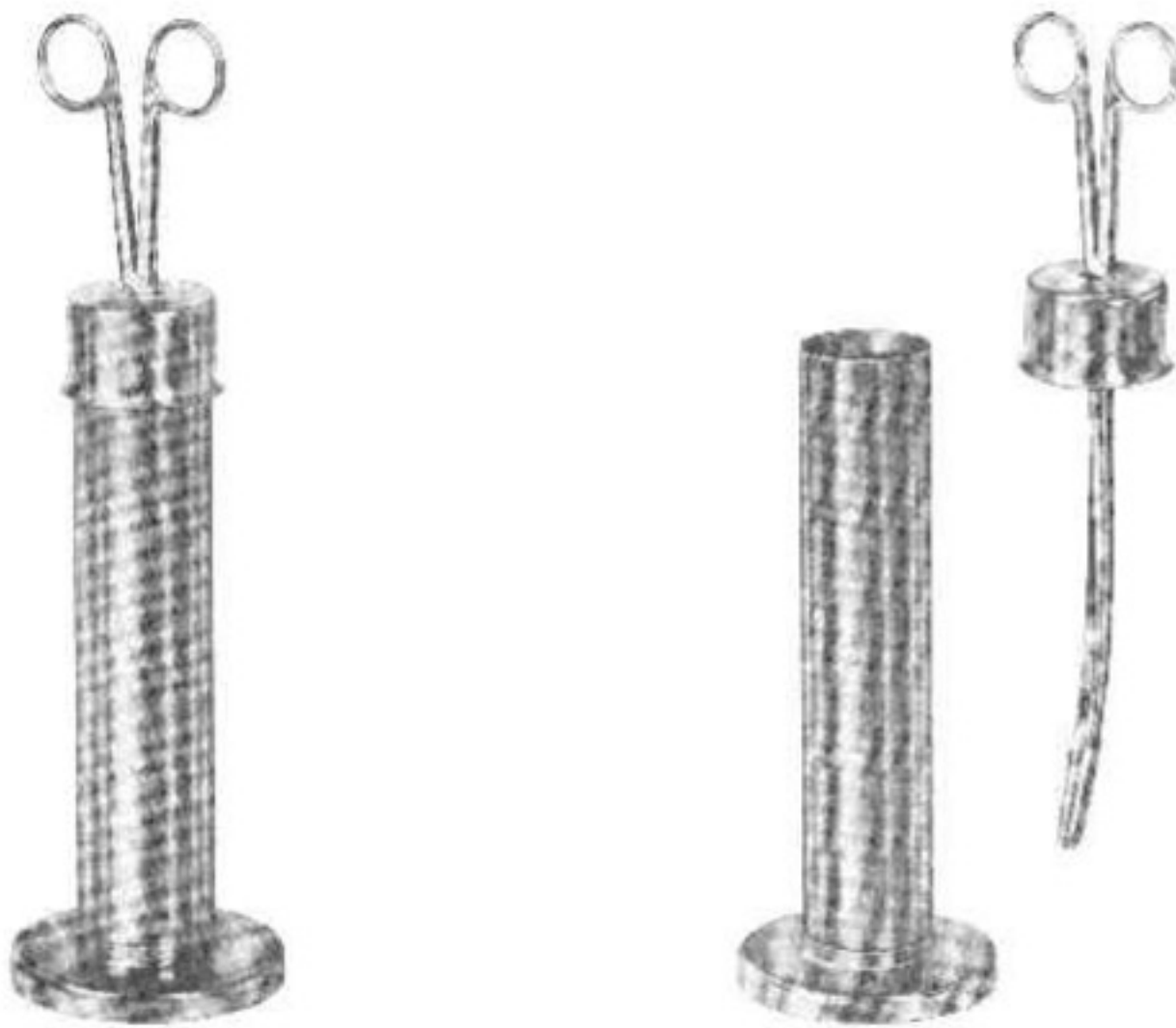

27-141 - 142

- 27-141 | Martin Sterilizing Forceps
consisting of:
1 Sterilizing Forceps, curved, 25 cm,
without ratchet, with lid for jar
1 jar with bottom plate (anti-tilt)
- 27-142 | ditto, with 32 cm long Sterilizing Forceps



27-143 - 148

	Ø x H
27-143	75 x 60 mm
27-144	75 x 75 mm
27-145	100 x 60 mm
27-146	100 x 100 mm
27-146A	125 x 80 mm
27-147	125 x 125 mm
27-148	150 x 150 mm



27-149
25 cc

27-150
50 cc



27-151
20 cc
Medicine Spoon



27-152
Ø75 x 12 mm
Tablet Tray



27-153
Ø90 x 90 mm
Metal Cup



27-154
Ø75 x 80 mm
Sputum Cup



Kidney Dish

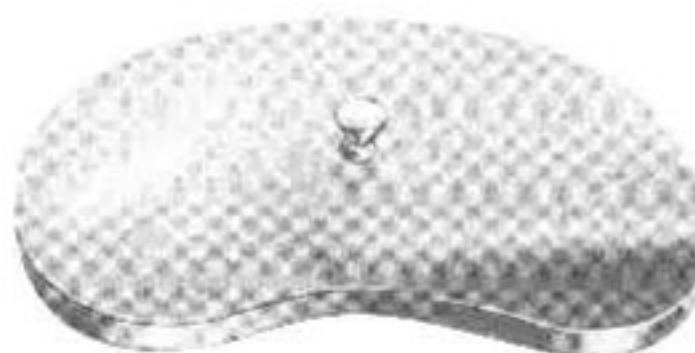

27-155 - 157

27-155	170 x 100 x 35 mm
27-156	250 x 140 x 40 mm
27-157	275 x 150 x 45 mm



27-158 - 165



27-166 - 170

	Ø x H			
27-158	40 x 19	mm		0.05L
27-159	61 x 30	mm		0.07L
27-160	80 x 40	mm		0.14L
27-161	116 x 50	mm		0.35L
27-162	128 x 55	mm		0.45L
27-163	147 x 65	mm		0.70L
27-164	167 x 75	mm		1.10L
27-165	187 x 85	mm		1.60L

27-166	116 x 35	mm		0.30L
27-167	128 x 38	mm		0.40L
27-168	147 x 40	mm		0.50L
27-169	157 x 45	mm		0.75L
27-170	187 x 45	mm		1.00L



27-171
Ø 110 x 28 mm 0.15L



27-172
100 cc 0.1L



27-173 - 176
27-173 0,25L
27-174 0,50L
27-175 1,00L
27-176 2,00L



27-177
235 x 190 x 40 mm



27-178
Ø 220 x 70 mm

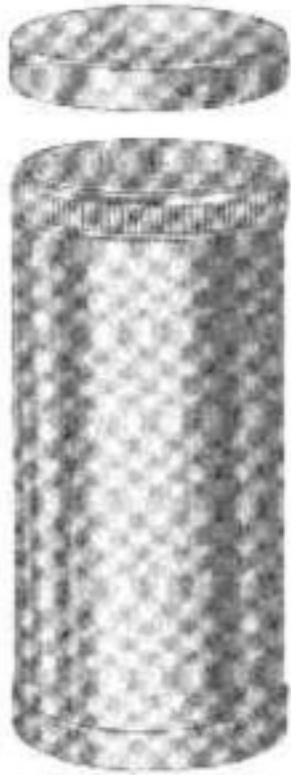

27-179
 ϕ 50 x 100 mm
 Powder Pot



27-180
 ϕ 50 x 75 mm
 Methot With Lid



27-181
 ϕ 50 x 75 mm
 Methot Without Lid



27-182

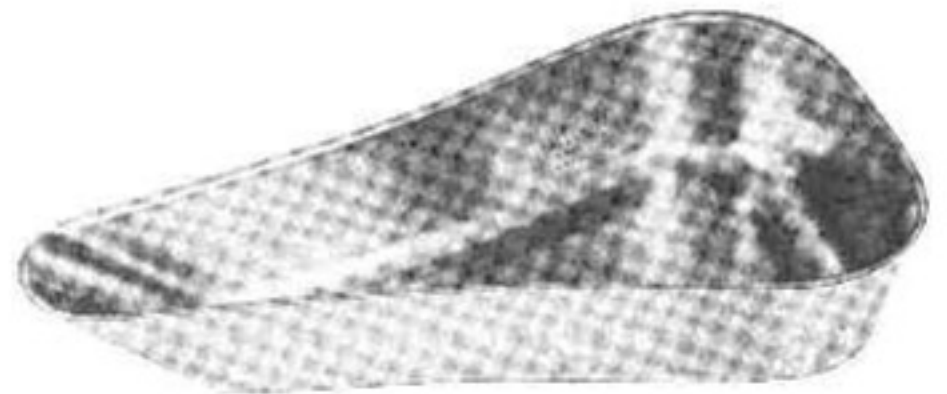

27-183

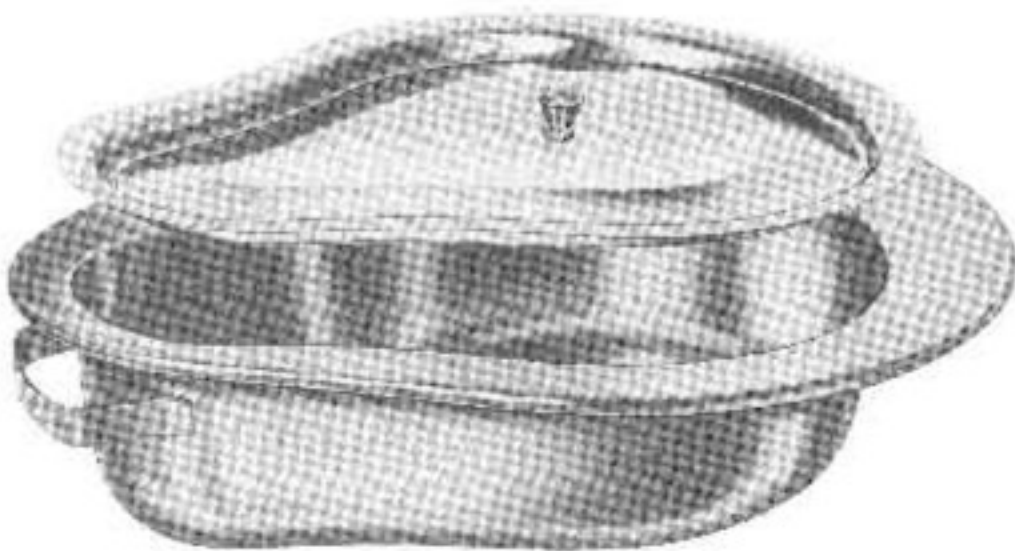

27-184

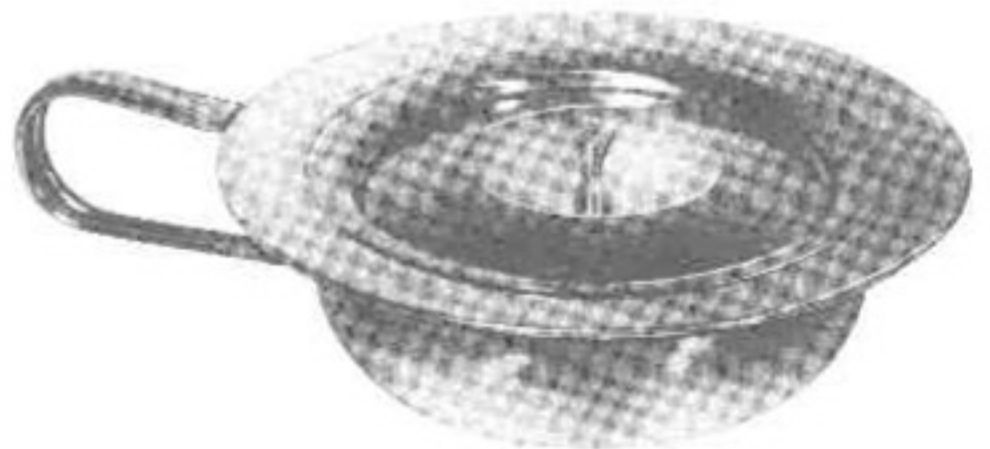

27-185 - 186

27-185 ϕ 235 mm
27-186 ϕ 310 mm



27-187
Sauerbruch
210 x 125 x 17 mm



27-188
Sauerbruch
210 x 125 x 17 mm



27-189
150 x 95 x 13 mm



27-190
150 x 95 x 13 mm



27-191
150 x 95 x 13 mm



27-192
150 x 95 x 13 mm



27-193
150 x 95 x 13 mm



27-194
150 x 95 x 13 mm



27-195
150 x 95 x 11 mm

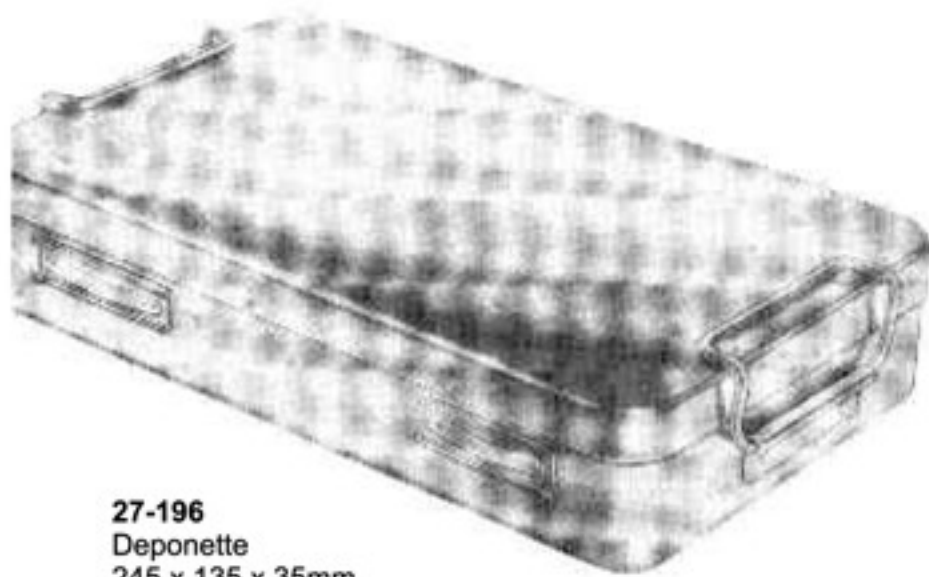

27-196
Deponette
245 x 135 x 35mm

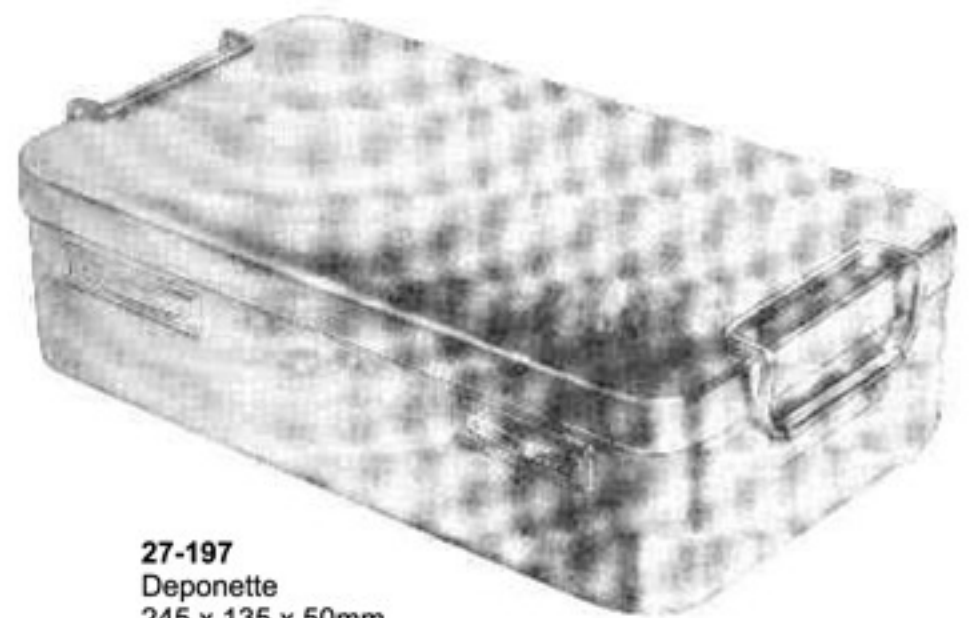

27-197
Deponette
245 x 135 x 50mm

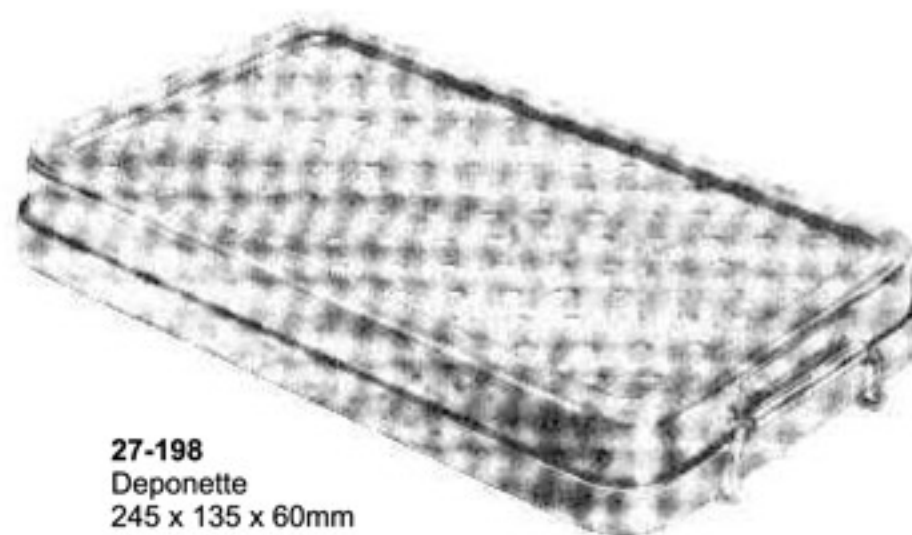

27-198
Deponette
245 x 135 x 60mm

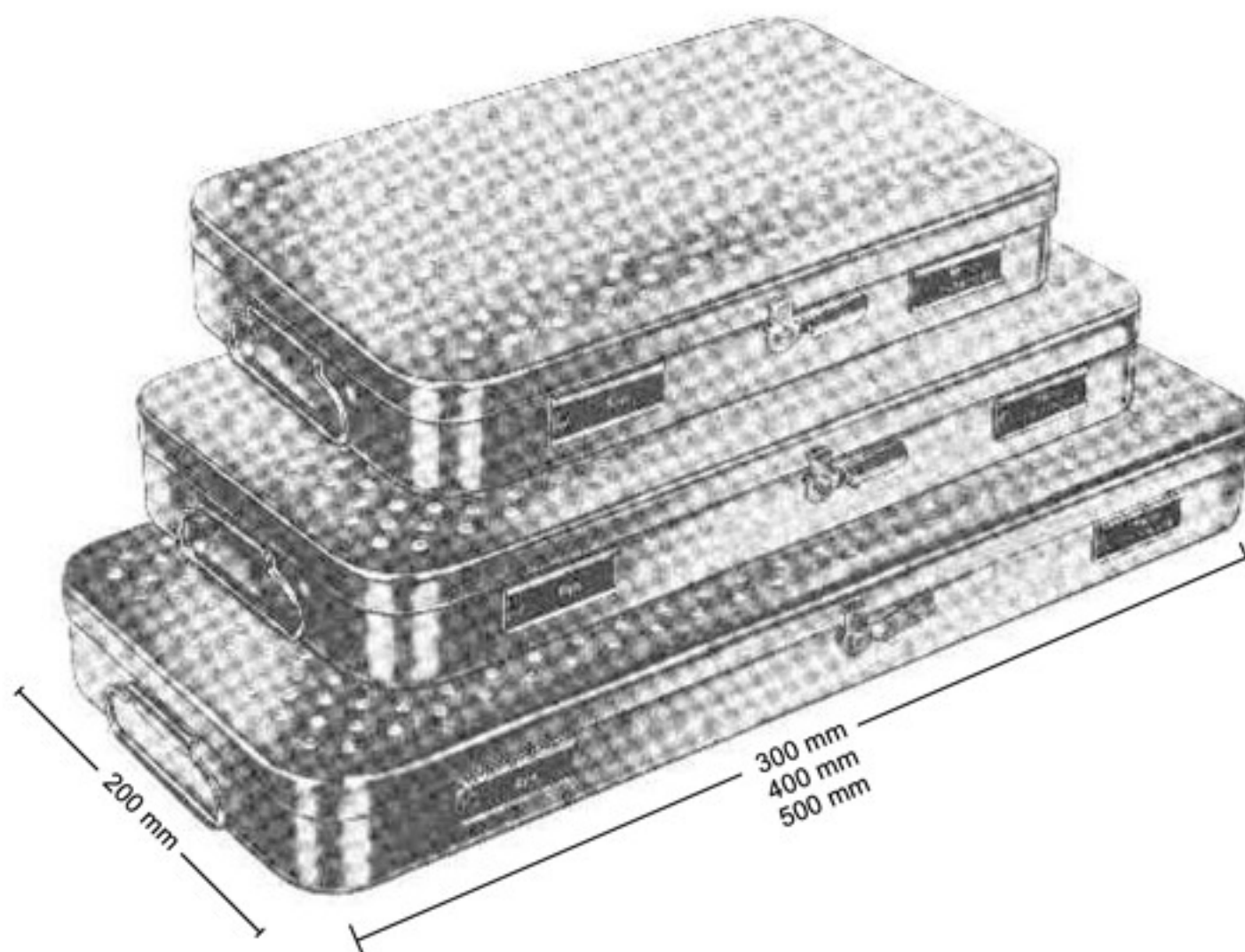

27-199 - 209

27-199	230 x 130 x 50	mm
27-200	260 x 150 x 50	mm
27-201	275 x 235 x 50	mm
27-202	300 x 200 x 50	mm
27-203	325 x 275 x 50	mm
27-204	420 x 175 x 50	mm
27-205	230 x 130 x 75	mm
27-206	260 x 150 x 75	mm
27-207	300 x 200 x 75	mm
27-208	325 x 275 x 75	mm
27-209	420 x 175 x 75	mm



27-210 - 212

27-210	480 x 250 x 50	mm
27-211	520 x 250 x 75	mm
27-212	520 x 250 x 100	mm



27-213 - 218

27-213	240 x 240 x 50	mm
27-214	240 x 240 x 80	mm
27-215	240 x 240 x 100	mm
27-216	480 x 260 x 50	mm
27-217	520 x 260 x 80	mm
27-218	520 x 260 x 100	mm

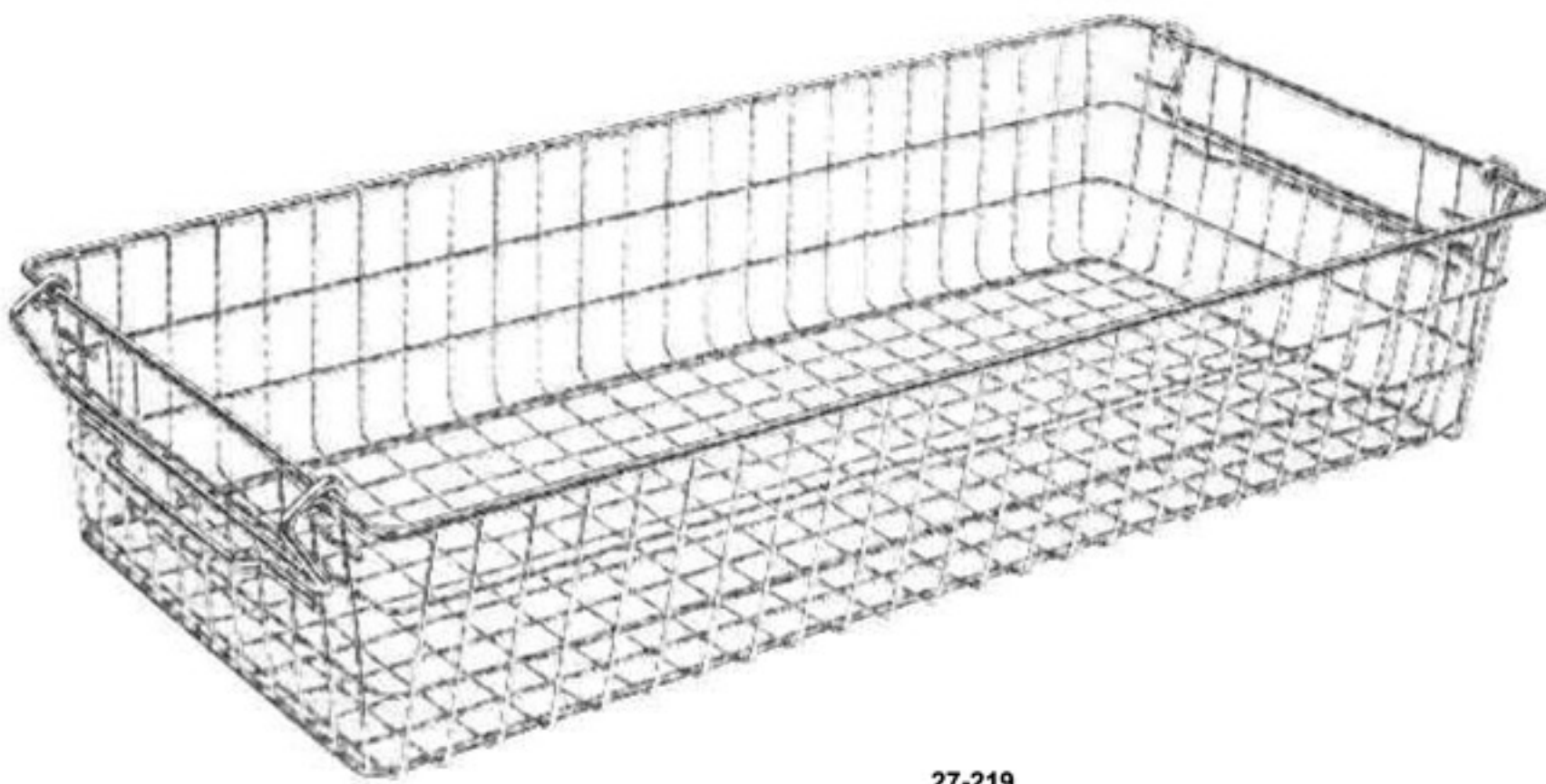

27-219
(60 x 30 x 15 cm)
Nominal dimensions